

EQUIN  X

MICRON DJ Booth Tri-colour Starcloth

User Manual

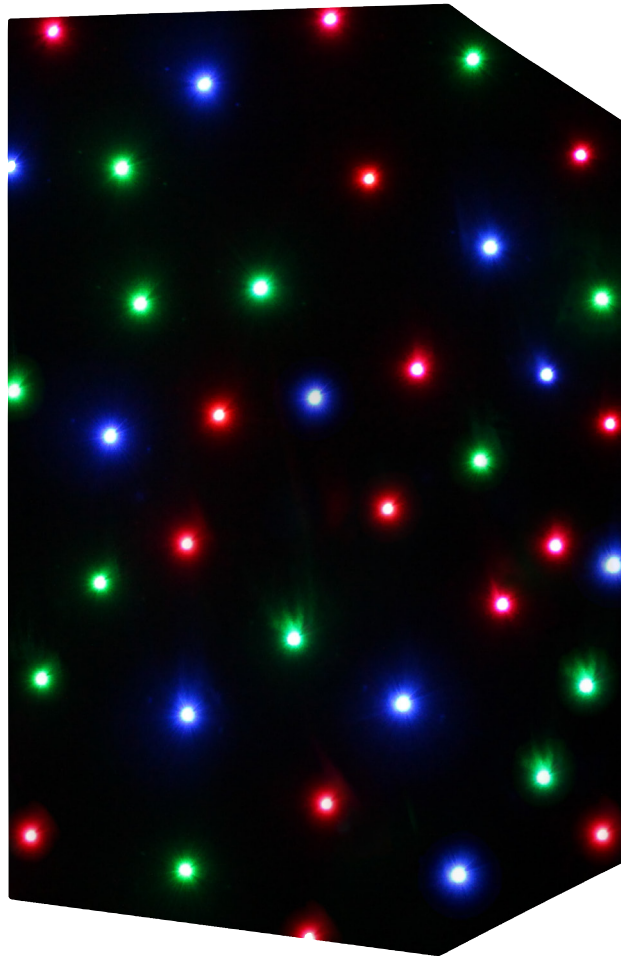

Order code: EQLED014C

WARNING

FOR YOUR OWN SAFETY, PLEASE READ THIS USER MANUAL CAREFULLY BEFORE YOUR INITIAL START-UP!

- Before your initial start-up, please make sure that there is no damage caused during transportation.
- Should there be any damage, consult your dealer and do not use the equipment.
- To maintain the equipment in good working condition and to ensure safe operation, it is necessary for the user to follow the safety instructions and warning notes written in this manual.
- Please note that damages caused by user modifications to this equipment are not subject to warranty.



IMPORTANT:

The manufacturer will not accept liability for any resulting damages caused by the non-observance of this manual or any unauthorised modification to the equipment.

- Never let the power cable come into contact with other cables. Handle the power cable and all mains voltage connections with particular caution!
- Never remove warning or informative labels from the unit.
- Do not open the equipment and do not modify the unit.
- Do not connect this equipment to a dimmer pack.
- Do not switch the equipment on and off in short intervals, as this will reduce the system's life.
- Only use the equipment indoors.
- Do not expose to flammable sources, liquids or gases.
- Always disconnect the power from the mains when equipment is not in use or before cleaning! Only handle the power-cable by the plug. Never pull out the plug by pulling the power-cable.
- Make sure that the available mains supply voltage is between 100~250V, 50/60Hz.
- Make sure that the power cable is never crimped or damaged. Check the equipment and the power cable periodically.
- If the equipment is dropped or damaged, disconnect the mains power supply immediately and have a qualified engineer inspect the equipment before operating again.
- If the equipment has been exposed to drastic temperature fluctuation (e.g. after transportation), do not connect power or switch it on immediately. The arising condensation might damage the equipment. Leave the equipment switched off until it has reached room temperature.
- If your product fails to function correctly, stop use immediately. Pack the unit securely (preferably in the original packing material), and return it to your Pro Light dealer for service.
- Only use fuses of same type and rating.
- To clean the cloth, disconnect the mains power supply and then wipe with a damp cloth. Do not immerse in liquid. The cloth will require monthly cleaning. Do not use alcohol or solvents. Connections and LEDs must be kept clean and dry at all times.
- Repairs, servicing and power connection must only be carried out by a qualified technician. **THIS UNIT CONTAINS NO USER SERVICEABLE PARTS.**
- **WARRANTY:** One year from date of purchase.

OPERATING DETERMINATIONS

If this equipment is operated in any other way, than those described in this manual, the product may suffer damage and the warranty becomes void. Incorrect operation may lead to danger e.g: short-circuit, burns and electric shocks etc.

Do not endanger your own safety and the safety of others!

Incorrect installation or use can cause serious damage to people and/or property.

MICRON DJ Booth Tri-colour Starcloth

Featuring 48 tri-colour 5050 LEDs, this MICRON DJ Booth starcloth comes supplied with an advanced DMX controller. The controller features solid colour selection coupled with pattern and speed control, allowing the DJ to match the starcloth colour to any other room lighting.

Cloth:

- 48 tri-colour 5050 LEDs
- Fast fixx velcro tabs
- Low reflection, fire retardant material

Controller:

- DMX channels: 3, 8 or 16 selectable
- Sound active, auto run, auto fade and master slave modes
- IEC power in socket
- 3-pin XLR DMX in/out sockets

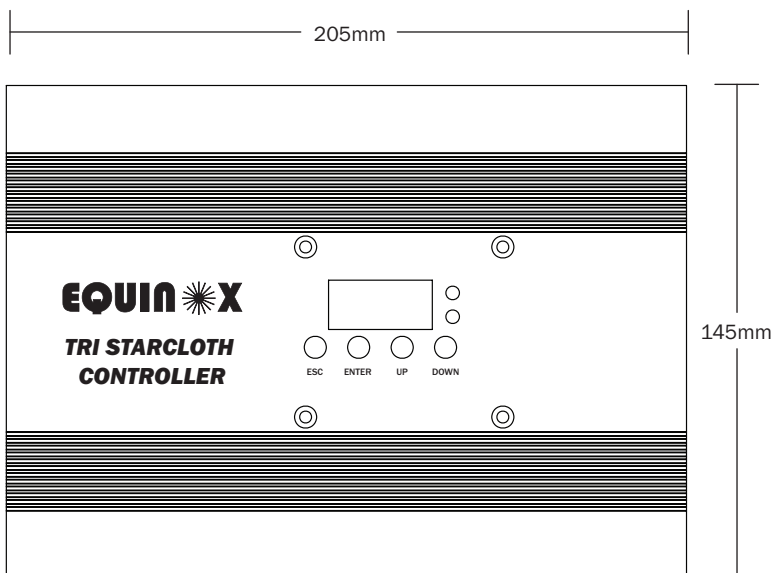
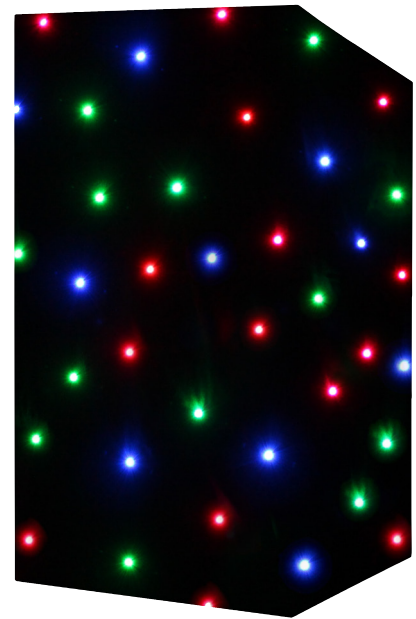

Specifications	Controller
Power supply	100~240V, 50/60Hz
Fuse	T1A 250V
Dimensions	55 x 205 x 145mm

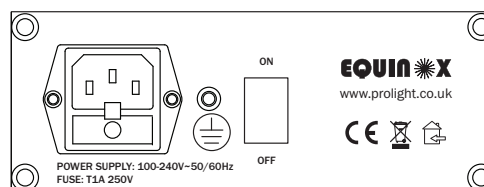
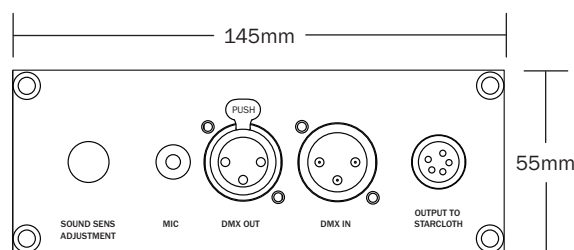

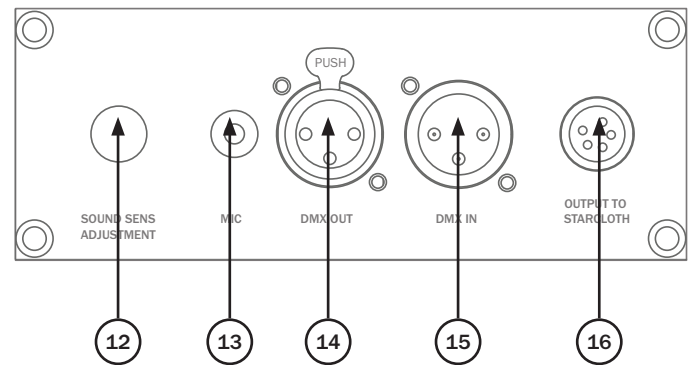
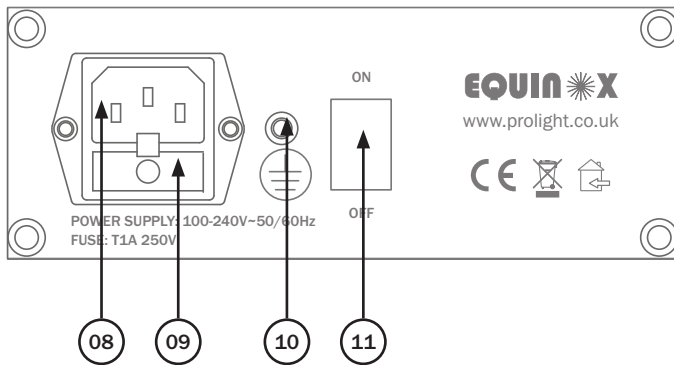
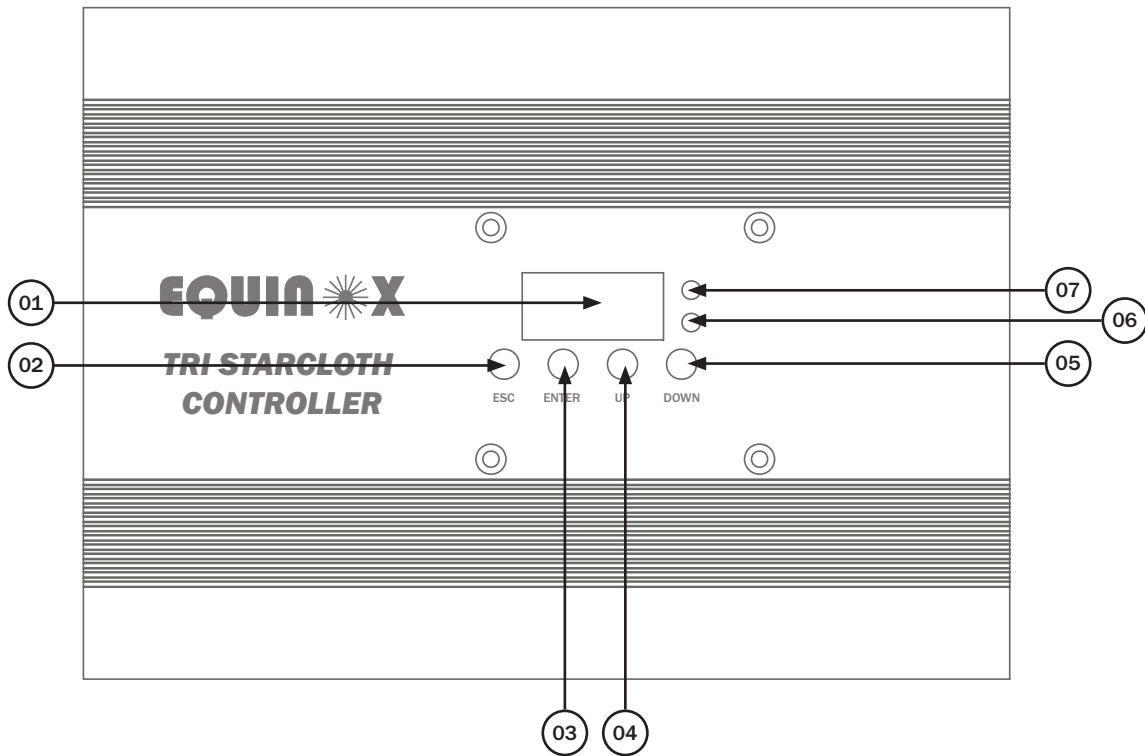

- | | | |
|-----------------------|-----------------------------------|--------------------------|
| 01 - LED display | 07 - Power indicator | 13 - Microphone |
| 02 - Esc button | 08 - Power in socket | 14 - DMX out |
| 03 - Enter button | 09 - Fuse T1A 250V | 15 - DMX in |
| 04 - Up button | 10 - Earth point | 16 - Output to starcloth |
| 05 - Down button | 11 - On/off switch | |
| 06 - Signal indicator | 12 - Sound sensitivity adjustment | |

In the box:
1 x starcloth,
1 x power cable,
1 x controller &
1 x user manual

Fitting instructions:

This cloth is designed to be fitted to the Equinox DJ Booth.

Fit the cloth from one upper corner first by hanging the sewn in pockets onto the booth.

Carefully unfold the cloth and attach the opposite corner, again by the sewn in pocket.

Once attached, the cloth must be tensioned by the integral velcro straps.

DMX channel selection

To access the channel selection, press the “**UP/DOWN**” buttons on the rear of the unit to show “**Ch - 5**” on the LED display. Now press the “**ENTER**” button and use the “**UP**” and “**DOWN**” buttons to choose between 3, 8 or 16 channel modes. Press the “**ENTER**” button to confirm the setting.

To exit out of any of the above options, press the “**ESC**” button.

Auto mode

To access the auto mode, press the “**UP/DOWN**” buttons on the rear of the unit to show “**Auto**” on the LED display. Now press the “**ENTER**” button and use the “**UP**” and “**DOWN**” buttons to set the auto pattern you require between “**Auto0**” and “**Auto9**” (**Auto9** is all pattern cycle run). Press the “**ENTER**” button to confirm the setting. Now use the “**UP**” and “**DOWN**” buttons to set the speed between “**A500**” and “**A599**” (slow to fast).

To exit out of any of the above options, press the “**ESC**” button.

Fade mode

To access the auto mode, press the “**UP/DOWN**” buttons on the rear of the unit to show “**FADE**” on the LED display. Now press the “**ENTER**” button and use the “**UP**” and “**DOWN**” buttons to set the fade mode you require between “**FA00**” and “**FA05**” (**FA05** is all fade cycle run). Press the “**ENTER**” button to confirm the setting. Now use the “**UP**” and “**DOWN**” buttons to set the speed between “**F500**” and “**F599**” (slow to fast).

To exit out of any of the above options, press the “**ESC**” button.

Sound active mode

To access the auto mode, press the “**UP/DOWN**” buttons on the rear of the unit to show “**Sound**” on the LED display. Now press the “**ENTER**” button and use the “**UP**” and “**DOWN**” buttons to set the sound control you require. Press the “**ENTER**” button to confirm the setting.

To exit out of any of the above options, press the “**ESC**” button.

Slave mode:

To access the slave mode, press the “**UP/DOWN**” buttons on the rear of the unit to show “**SLAVE**” on the LED display. The unit is now in slave mode. Press the “**ENTER**” button to confirm the setting.

DMX address:

To change the DMX address, press the “**UP/DOWN**” buttons on the rear of the unit to show “**Addr**” on the LED display. Now press the “**ENTER**” button and use the “**UP**” and “**DOWN**” buttons to set the address you require. Press the “**ENTER**” button to confirm the setting.

To exit out of any of the above options, press the “**ESC**” button.

Static colour mode:

To access static colour mode, press the “**UP/DOWN**” buttons on the rear of the unit to show “**Static**” on the LED display. Now press the “**ENTER**” button and use the “**UP**” and “**DOWN**” buttons to set the the colour required. Press the “**ENTER**” button to confirm the setting. Now use the “**UP**” and

“DOWN” buttons to set the the colour flash pattern required. Press the “ENTER” button to confirm the setting. Now use the “UP” and “DOWN” buttons to set the the flash speed required. Press the “ENTER” button to confirm the setting.

To exit out of any of the above options, press the “ESC” button.

Static colours are as below:

- Co00 - Red
- Co01 - Green
- Co02 - Blue
- Co03 - Yellow
- Co04 - Purple
- Co05 - Turquoise
- Co06 - Pink
- Co07 - Orange
- Co08 - Light Yellow
- Co09 - Light Purple
- Co10 - White

3 channel mode:

Channel	Value	Function
1	0-14	Blackout
	15-29	Red
	30-44	Green
	45-59	Blue
	60-74	Yellow
	75-89	Purple
	90-104	Cyan
	105-119	Pink
	120-134	Dark Orange
	135-149	Light Yellow
	150-164	Light Purple
	165-179	Gold
	180-194	Light Green
	195-209	Light Pink
	210-224	Dark Purple
	225-239	Orange
240-255	White	

Colour mix mode

To access the colour mix mode, press the “UP/DOWN” buttons on the rear of the unit to show “CoLo” on the LED display. Now press the “ENTER” button and use the “UP” and “DOWN” buttons to set the amount of red you require. Press the “ENTER” button to confirm the setting. Repeat this step for the Green, Blue colours, colour flash patterns and flash speed.

To exit out of any of the above options, press the “ESC” button.

Software version

To view the software version, press the “UP/DOWN” buttons on the rear of the unit to show “U- - -”, this now shows the software version.

Channel	Value	Function
2	0-9	Static pattern 1
	10-19	Static pattern 2
	20-29	Static pattern 3
	30-39	Static pattern 4
	40-49	Static pattern 5
	50-59	Static pattern 6
	60-69	Static pattern 7
	70-79	Static pattern 8
	80-119	Static pattern cycle (1-8)
	120-129	Multi colour pattern 1
	130-139	Multi colour pattern 2
	140-149	Multi colour pattern 3
	150-159	Multi colour pattern 4
	160-169	Multi colour pattern 5
	170-179	Multi colour pattern 6
	180-189	Multi colour pattern 7
190-199	Multi colour pattern 8	
200-209	Multi colour pattern 9	
210-255	Multi colour pattern cycle (1-9)	
3	0-9	Stop (static pattern)
	10-200	Slow to fast (static pattern)
	0-200	Slow to fast (multi colour pattern)
	201-255	Sound active

8 channel mode:

Channel	Value	Function
1	0-9	Blackout
	10-19	Red
	20-29	Green
	30-39	Blue
	40-49	Yellow
	50-59	Purple
	60-69	Cyan
	70-79	Pink
	80-89	Dark Orange
	90-99	Light Yellow
	100-109	Light Purple
	110-119	White
	120-129	Pattern 1
	130-139	Pattern 2
	140-149	Pattern 3
	150-159	Pattern 4
	160-169	Pattern 5
	170-179	Pattern 6
	180-189	Pattern 7
	190-199	Pattern 8
200-209	Pattern 9	
210-219	Pattern cycle (1-9)	
220-255	Pattern cycle via sound active (1-9)	
2	0-9	Stop (static colour & mix colour patterns speed adjustment, CH1 only, value 0-119)
	10-255	Slow to fast (static colour & mix colour patterns speed adjustment, CH1 only, value 0-119)
3	0-255	Slow to fast (auto shift patterns speed adjustment (CH1 only, value 120-219)
4	0-255	Red 0-100% (CH1 only, value 0-9)
5	0-255	Green 0-100% (CH1 only, value 0-9)
6	0-255	Blue 0-100% (CH1 only, value 0-9)
7	0-29	Static colour pattern 1 (CH1 only, value 10-119)
	30-59	Static colour pattern 2 (CH1 only, value 10-119)
	60-89	Static colour pattern 3 (CH1 only, value 10-119)
	90-119	Static colour pattern 4 (CH1 only, value 10-119)
	120-149	Static colour pattern 5 (CH1 only, value 10-119)
	150-179	Static colour pattern 6 (CH1 only, value 10-119)
	180-209	Static colour pattern 7 (CH1 only, value 10-119)
	210-239	Static colour pattern 8 (CH1 only, value 10-119)
	240-255	Static colour pattern cycle (1-8), (CH1 only, value 10-119)

Cont...

8	0-29	Mixed colour pattern 1 (CH1 only, value 0-9)
	30-59	Mixed colour pattern 2 (CH1 only, value 0-9)
	60-89	Mixed colour pattern 3 (CH1 only, value 0-9)
	90-119	Mixed colour pattern 4 (CH1 only, value 0-9)
	120-149	Mixed colour pattern 5 (CH1 only, value 0-9)
	150-179	Mixed colour pattern 6 (CH1 only, value 0-9)
	180-209	Mixed colour pattern 7 (CH1 only, value 0-9)
	210-255	Mixed colour pattern cycle (1-7), (CH1 only, value 0-9)

16 channel mode:

Channel	Value	Function
1	0-9	Blackout
	10-19	Red
	20-29	Green
	30-39	Blue
	40-49	Yellow
	50-59	Purple
	60-69	Cyan
	70-79	Pink
	80-89	Dark Orange
	90-99	Light Yellow
	100-109	Light Purple
	110-119	White
	120-129	Pattern 1
	130-139	Pattern 2
	140-149	Pattern 3
	150-159	Pattern 4
	160-169	Pattern 5
	170-179	Pattern 6
	180-189	Pattern 7
	190-199	Pattern 8
200-209	Pattern 9	
	210-219	Pattern cycle (1-9)
	220-255	Pattern cycle via sound active (1-9)
2	0-9	Stop (static colour & mix colour patterns/mix colour strobe speed adjustment, CH1 only, value 0-119)
	10-255	Slow to fast (static colour & mix colour patterns/mix colour strobe speed adjustment, CH1 only, value 0-119)
3	0-255	Slow to fast (auto shift patterns speed adjustment (CH1 only, value 120-219)

Cont...

4	0-29	Static colour pattern 1 (CH1 only, value 10-119)
	30-59	Static colour pattern 2 (CH1 only, value 10-119)
	60-89	Static colour pattern 3 (CH1 only, value 10-119)
	90-119	Static colour pattern 4 (CH1 only, value 10-119)
	120-149	Static colour pattern 5 (CH1 only, value 10-119)
	150-179	Static colour pattern 6 (CH1 only, value 10-119)
	180-209	Static colour pattern 7 (CH1 only, value 10-119)
	210-239	Static colour pattern 8 (CH1 only, value 10-119)
	240-255	Static colour pattern cycle (1-8), (CH1 only, value 10-119)
5	0-255	Red 1, 0-100% (CH1 only, value 0-9)
6	0-255	Green 1, 0-100% (CH1 only, value 0-9)
7	0-255	Blue 1, 0-100% (CH1 only, value 0-9)
8	0-255	Red 2, 0-100% (CH1 only, value 0-9)
9	0-255	Green 2, 0-100% (CH1 only, value 0-9)
10	0-255	Blue 2, 0-100% (CH1 only, value 0-9)
11	0-255	Red 3, 0-100% (CH1 only, value 0-9)
12	0-255	Green 3, 0-100% (CH1 only, value 0-9)
13	0-255	Blue 3, 0-100% (CH1 only, value 0-9)
14	0-255	Red 4, 0-100% (CH1 only, value 0-9)
15	0-255	Green 4, 0-100% (CH1 only, value 0-9)
16	0-255	Blue 4, 0-100% (CH1 only, value 0-9)

Setting the DMX address:

The DMX mode enables the use of a universal DMX controller. Each fixture requires a “start address” from 1- 512. A fixture requiring one or more channels for control begins to read the data on the channel indicated by the start address. For example, a fixture that occupies or uses 7 channels of DMX and was addressed to start on DMX channel 100, would read data from channels: 100,101,102,103,104,105 and 106. Choose a start address so that the channels used do not overlap. E.g. the next unit in the chain starts at 107.

DMX 512:

DMX (Digital Multiplex) is a universal protocol used as a form of communication between intelligent fixtures and controllers. A DMX controller sends DMX data instructions from the controller to the fixture. DMX data is sent as serial data that travels from fixture to fixture via the DATA “IN” and DATA “OUT” XLR terminals located on all DMX fixtures (most controllers only have a data “out” terminal).

DMX linking:

DMX is a language allowing all makes and models of different manufactures to be linked together and operate from a single controller, as long as all fixtures and the controller are DMX compliant.

To ensure proper DMX data transmission, when using several DMX fixtures try to use the shortest cable path possible. The order in which fixtures are connected in a DMX line does not influence the DMX addressing. For example; a fixture assigned to a DMX address of 1 may be placed anywhere in a DMX line, at the beginning, at the end, or anywhere in the middle. When a fixture is assigned a DMX address of 1, the DMX controller knows to send DATA assigned to address 1 to that unit, no matter where it is located in the DMX chain.

DATA cable (DMX cable) requirements (for DMX operation):

This fixture can be controlled via DMX-512 protocol. The DMX address is set on the back of the unit. Your unit and your DMX controller require a standard 3-pin XLR connector for data input/output, see image below.



Further DMX cables can be purchased from all good sound and lighting suppliers or Pro Light Concepts dealers. Please quote:
CABL10 – 2m
CABL11 – 5m
CABL12 – 10m

Note: DMX cable must be daisy chained and cannot be split.

Notice:

Be sure to follow the diagrams below when making your own cables. Do not connect the cables shield conductor to the ground lug or allow the shield conductor to come in contact with the XLRs outer casing. Grounding the shield could cause a short circuit and erratic behaviour.

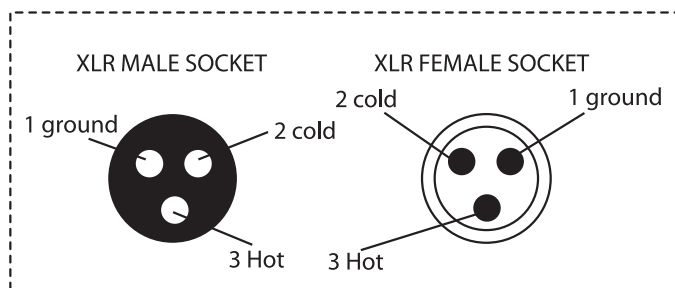
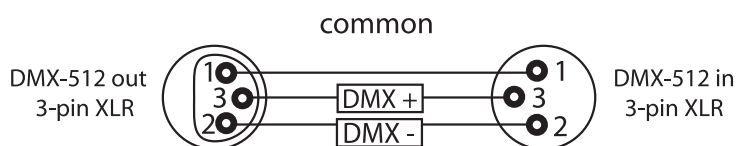

XLR Pin Configuration
Pin 1 = Ground
Pin 2 = Negative
Pin 3 = Postive

Special note:

Line termination:

When longer runs of cable are used, you may need to use a terminator on the last unit to avoid erratic behaviour.

Using a cable terminator will decrease the possibilities of erratic behaviour.

(3-pin - Order code: CABL90, 5-pin - Order code: CABL89)

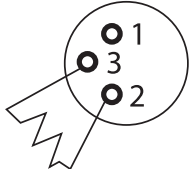

Termination reduces signal transmission problems and interference. It is always advisable to connect a DMX terminal, (resistance 120 Ohm 1/4 W) between pin 2 (DMX-) and pin 3 (DMX+) of the last fixture.

5-pin XLR DMX connectors:

Some manufactures use 5-pin XLR connectors for data transmission in place of 3-pin. 5-pin XLR fixtures may be implemented in a 3-pin XLR DMX line. When inserting standard 5-pin XLR connectors in to a 3-pin line a cable adaptor must be used. The diagram below details the correct cable conversion.

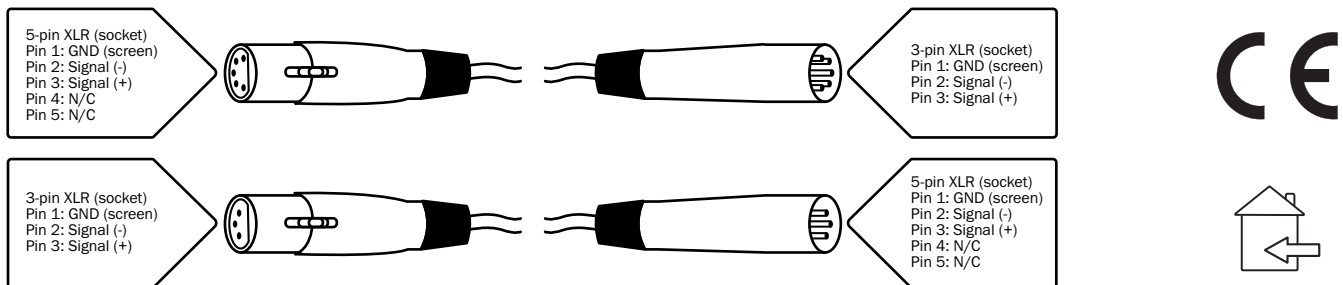

**Correct Disposal of this Product
(Waste Electrical & Electronic Equipment)**

(Applicable in the European Union and other European countries with separate collection systems)

This marking shown on the product or its literature, indicates that it should not be disposed of with other household wastes at the end of its working life. To prevent possible harm to the environment or human health from uncontrolled waste disposal, please separate this from other types of wastes and recycle it responsibly to promote the sustainable reuse of material resources.

Household users should contact either the retailer where they purchased this product, or their local government office, for details of where and how they can take this item for environmentally safe recycling.

Business users should contact their supplier and check the terms and conditions of the purchase contract. This product should not be mixed with other commercial wastes for disposal.

Please contact your local retailer to purchase these related items.

Optional accessories	Order code
MICRON DJ Booth & Overhead kit	EQLED014
Black cloth	EQLED014D
Black starcloth with white LEDs	EQLED014A
LCD TV Bracket	EQLED014B

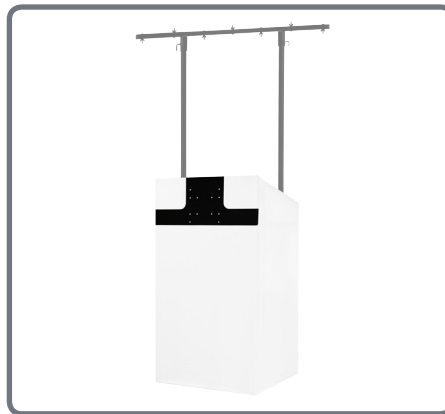

Optional LCD TV Bracket
Order code: EQLED014B

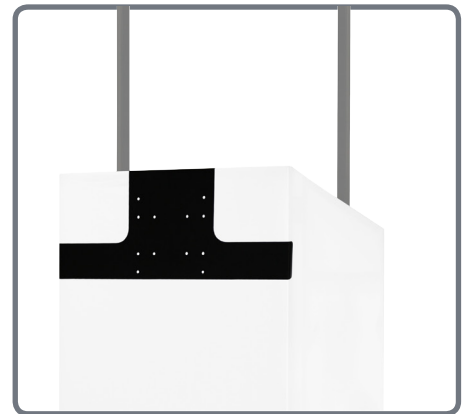

LCD TV Bracket close-up



Optional Black Starcloth with white LEDs and controller
Order code: EQLED014A



MICRON DJ Booth & Overhead kit
Order code: EQLED014

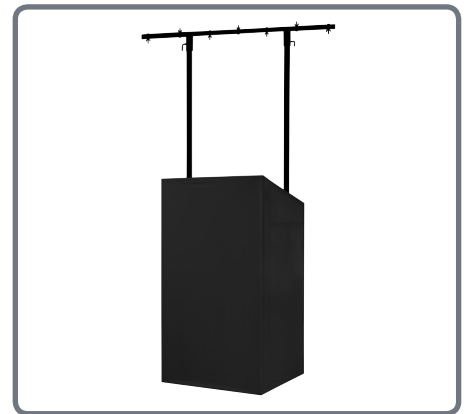

Optional Black Cloth
Order code: EQLED014D