

EQUINOX

Power Par 54 MKII

User Manual



Order code: EQLED114

WARNING

FOR YOUR OWN SAFETY, PLEASE READ THIS USER MANUAL CAREFULLY BEFORE YOUR INITIAL START-UP!

- Before your initial start-up, please make sure that there is no damage caused during transportation.
- Should there be any damage, consult your dealer and do not use the equipment.
- To maintain the equipment in good working condition and to ensure safe operation, it is necessary for the user to follow the safety instructions and warning notes written in this manual.
- Please note that damages caused by user modifications to this equipment are not subject to warranty.



IMPORTANT:

The manufacturer will not accept liability for any resulting damages caused by the non-observance of this manual or any unauthorised modification to the equipment.

- Never let the power cable come into contact with other cables. Handle the power cable and all mains voltage connections with particular caution!
- Never remove warning or informative labels from the unit.
- Do not open the equipment and do not modify the unit.
- Do not connect this equipment to a dimmer pack.
- Do not switch the equipment on and off in short intervals, as this will reduce the system's life.
- Only use the equipment indoors.
- Do not expose to flammable sources, liquids or gases.
- Always disconnect the power from the mains when equipment is not in use or before cleaning! Only handle the power-cable by the plug. Never pull out the plug by pulling the power-cable.
- Make sure that the available mains supply voltage is between 100~240V AC, 50/60Hz.
- Make sure that the power cable is never crimped or damaged. Check the equipment and the power cable periodically.
- If the equipment is dropped or damaged, disconnect the mains power supply immediately and have a qualified engineer inspect the equipment before operating again.
- If the equipment has been exposed to drastic temperature fluctuation (e.g. after transportation), do not connect power or switch it on immediately. The arising condensation might damage the equipment. Leave the equipment switched off until it has reached room temperature.
- If your product fails to function correctly, stop use immediately. Pack the unit securely (preferably in the original packing material), and return it to your Pro Light dealer for service.
- Only use fuses of same type and rating.
- Repairs, servicing and power connection must only be carried out by a qualified technician. THIS UNIT CONTAINS NO USER SERVICEABLE PARTS.
- This lighting fixture is for professional use only - it is not designed for or suitable for household use. The product must be installed by a qualified technician in accordance with local territory regulations. The safety of the installation is the responsibility of the installer. The fixture presents risks of severe injury or death due to fire hazards, electric shock and falls.
- Warning! Risk Group 2 LED product according to EN 62471. Do not view the light output with optical instruments or any device that may concentrate the beam.
- WARRANTY: One year from date of purchase.

OPERATING DETERMINATIONS

If this equipment is operated in any other way, than those described in this manual, the product may suffer damage and the warranty becomes void. Incorrect operation may lead to danger e.g: short-circuit, burns and electric shocks etc.

Do not endanger your own safety and the safety of others!

Incorrect installation or use can cause serious damage to people and/or property.

Power Par 54 MKII

The Power Par 54 MKII is a powerful fixture that feature tri-colour LEDs and produce a range of effects including colour change and fade, controllable in auto and sound active modes along with DMX. A dual bracket is included allowing the fixture to be hung or stood on the floor.

- 54 x 3W tri-colour LEDs (RGB)
- Beam angle: 25°
- 1721 Lux @ 2m (full on)
- DMX channels: 6
- Auto, sound active and master/slave modes
- 0-100% dimming and variable strobe
- 4 push button menu with LED display
- Bracket allows for multiple rigging or floor standing applications
- IEC power input/output
- 3-Pin XLR input/output
- Fan cooled



Specifications	Power Par 54 MKII
Power consumption	165W
Power supply	100~240V, 50/60Hz
Fuse	F3A 250V
Dimensions	285 x 266 x 94mm
Weight	1.5kg
Order codes	EQLED114

25° - Lux					
FULL ON	6884	1721	764	430	275
R	4436	1109	492	277	177
G	9768	2442	1085	610	390
B	2052	513	228	128	82

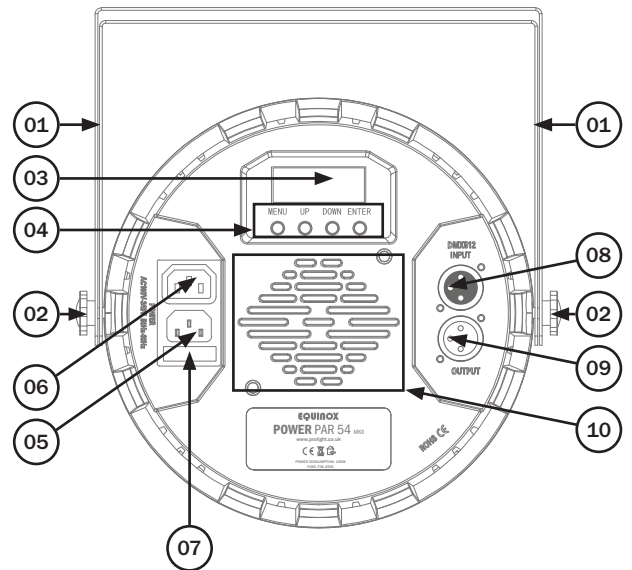
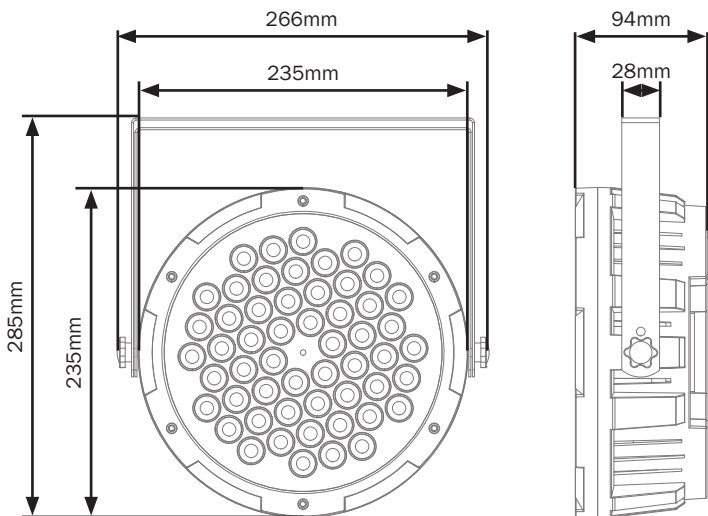
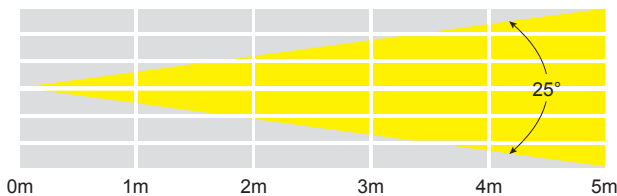

- 01 - Hanging bracket
- 02 - Hanging bracket adjustment knob
- 03 - LED display
- 04 - Function buttons
- 05 - IEC power input
- 06 - IEC power output
- 07 - Fuse: F3A 250V
- 08 - 3-Pin DMX input
- 09 - 3-Pin DMX output
- 10 - Fan

In the box:
1 x fixture,
1 x power cable
& 1 x user manual

DMX mode:

Operating in a DMX control mode environment gives the user the greatest flexibility when it comes to customising or creating a show. In this mode you will be able to control each individual trait of the fixture and each fixture independently.

To access the DMX address mode, press the “**MENU**” button on the front of the unit to show *ADD 1* on the LED display. Now press the “**ENTER**” button and use the “**UP**” and “**DOWN**” buttons to set the required DMX address. Press the “**ENTER**” button to confirm the setting.

To exit out of any of the above options, press the “**MENU**” button.

6 channel mode:

Channel	Value	Function
CH1	000-255	Red dimmer (0-100%)
CH2	000-255	Green dimmer (0-100%)
CH3	000-255	Blue dimmer (0-100%)
CH4	000-027	No function
	028-055	Strobe (use CH6 for speed)
	056-083	Strobe with colour change (use CH6 for speed)
	084-111	Red
	112-139	Green
	140-167	Blue
	168-195	Yellow
	196-223	Purple
	224-251	Cyan
	252-255	White

CH5	000	No function	(use CH6 for speed)
	001-012	Red fade in/out	
	013-025	Green fade in/out	
	026-038	Blue fade in/out	
	039-051	Yellow fade in/out	
	052-064	Purple fade in/out	
	065-077	Cyan fade in/out	
	078-090	White fade in/out	
	091-116	Auto colour fade in/out	
	117-142	Colour fade	
	143-168	Colour change	
	169-181	Colour change with strobe	
	182-207	All auto shows	
	208-255	Sound active flash (when CH6 is 000)	
	208-255	Sound active (when CH6 is 001-255)	
CH6	000-255	Speed (slow-fast)/Sensitivity (low-high)	

RGB colour mix mode:

In this mode you can set the fixture to any colour and any brightness.

To access the colour mix mode press “**MENU**” until the display shows *Pr - -* on the LED display.

Press the “**ENTER**” button and use the “**UP**” and “**DOWN**” buttons to select *Pr 00*.

Press the “**ENTER**” button to show *r - - -* with 3 digits after on the LED display.

Press the “**ENTER**” button to confirm.

The *r* represents red, *G* = green and *b* = blue.

The 3 digits after are the brightness setting from *000 ~ 255*.

For example:

If you set *r*, *G*, *b* all to zero, your unit will have no LEDs lit up (blackout).

If you set *r 000* to *r 255* and *G* and *b* to zero, your unit will show only red LEDs.

Press the “**ENTER**” button to confirm the setting and move to the next colour.

To exit out of any of the above options, press the “**MENU**” button.

Built-in program mode:

To access built-in program mode press “MENU” until the display shows *Pr - -* on the LED display. Press the “ENTER” button and use the “UP” and “DOWN” buttons to select between *Pr 00 ~ Pr 13*. Press the “ENTER” button and use the “UP” and “DOWN” buttons to select the speed between *SP 00 ~ SP 20*. Press the “ENTER” button to confirm.

To exit out of any of the above options, press the “MENU” button.

Sound active mode:

To access the sound active mode, press the “MENU” button on the front of the unit to show *Sound* on the LED display. Now press the “ENTER” button and the display will show *SPn5*. Press the “ENTER” button again and use the “UP” and “DOWN” buttons to select the sensitivity level from 000-100. Press the “ENTER” button to confirm the setting.

Value: 000 - 100 (000 = low, 100 = high)

To exit out of any of the above options, press the “MENU” button.

Master/slave mode:

To set the master unit, press the “MENU” button on the rear of the master unit to select your desired program (sound active or RGB colour mix).

To set the other units in slave mode, press the “MENU” button on the rear of the unit to show *SLAU* on the LED display and press the “ENTER” button to confirm the setting. The units will now run in sequence with the master unit.

To exit out of any of the above options, press the “MENU” button.

Menu system

Built-in program mode Pr00 - Pr13	<i>Pr 00</i> - RGB colour mix mode <i>r 000 ~ r 255</i> R <i>G 000 ~ G 255</i> G <i>b 000 ~ b 255</i> B <i>Pr 01</i> - R <i>Pr 02</i> - G <i>Pr 03</i> - B <i>Pr 04</i> - RG <i>Pr 05</i> - RB <i>Pr 06</i> - GB <i>Pr 07</i> - RGB <i>Pr 08</i> - Colour fade in-out (3 colours) <i>Pr 09</i> - Colour fade in-out (7 colours) <i>Pr 10</i> - Colour fade <i>Pr 11</i> - Colour fade in-out (7 colours) & colour fade <i>Pr 12</i> - Colour change (3 colours) <i>Pr 13</i> - Colour change (7 colours)
Slave mode	<i>SLAU</i>
Sound active mode	<i>Sound</i> <i>SPn5</i> <i>000 ~ 100</i>
DMX mode	6CH
Address setting	<i>ADD 1 ~ R5 12</i>

Setting the DMX address:

The DMX mode enables the use of a universal DMX controller. Each fixture requires a “start address” from 1- 512. A fixture requiring one or more channels for control begins to read the data on the channel indicated by the start address. For example, a fixture that occupies or uses 7 channels of DMX and was addressed to start on DMX channel 100, would read data from channels: 100, 101, 102, 103, 104, 105 and 106. Choose a start address so that the channels used do not overlap. E.g. the next unit in the chain starts at 107.

DMX 512:

DMX (Digital Multiplex) is a universal protocol used as a form of communication between intelligent fixtures and controllers. A DMX controller sends DMX data instructions from the controller to the fixture. DMX data is sent as serial data that travels from fixture to fixture via the DATA “IN” and DATA “OUT” XLR terminals located on all DMX fixtures (most controllers only have a data “out” terminal).

DMX linking:

DMX is a language allowing all makes and models of different manufactures to be linked together and operate from a single controller, as long as all fixtures and the controller are DMX compliant. To ensure proper DMX data transmission, when using several DMX fixtures try to use the shortest cable path possible. The order in which fixtures are connected in a DMX line does not influence the DMX addressing. For example; a fixture assigned to a DMX address of 1 may be placed anywhere in a DMX line, at the beginning, at the end, or anywhere in the middle. When a fixture is assigned a DMX address of 1, the DMX controller knows to send DATA assigned to address 1 to that unit, no matter where it is located in the DMX chain.

DATA cable (DMX cable) requirements (for DMX operation):

This fixture can be controlled via DMX-512 protocol. The DMX address is set on the back of the unit. Your unit requires either a standard 3-pin or 5-pin XLR connector for data input/output, see images below.



Further DMX cables can be purchased from all good sound and lighting suppliers or Prolight Concepts dealers.

Please quote:	3-Pin:	CABL10 – 2m	CABL11 – 5m	CABL12 – 10m
	5-Pin:	CABL185 – 2m	CABL187 – 5m	CABL188 – 10m

Also remember that DMX cable must be daisy chained and cannot be split.

Notice:

Be sure to follow the diagrams below when making your own cables. Do not connect the cables shield conductor to the ground lug or allow the shield conductor to come in contact with the XLRs outer casing. Grounding the shield could cause a short circuit and erratic behaviour.

Pin Configuration	
3-Pin	5-Pin
	Pin 1 - Ground
	Pin 2 - Negative
	Pin 3 - Positive
-	Pin 4 - N/C
-	Pin 5 - N/C

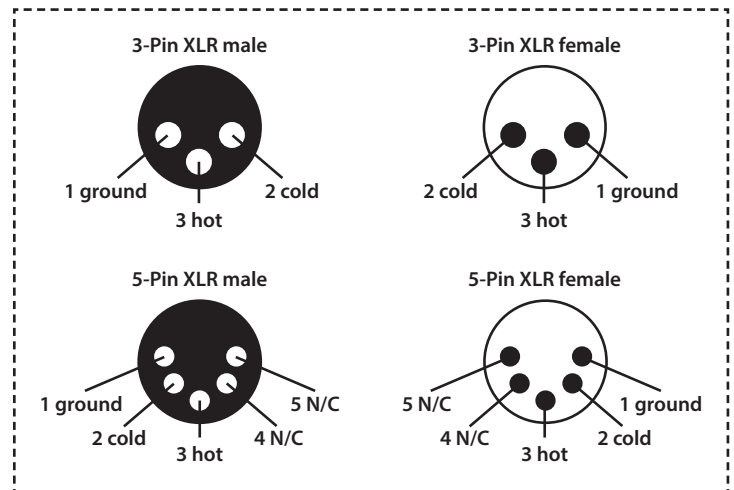
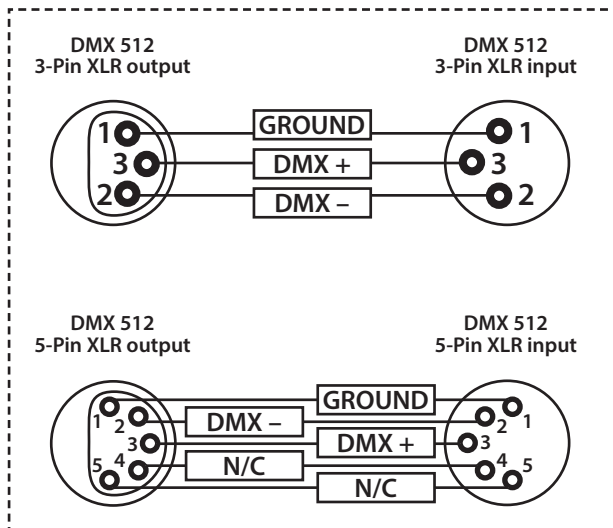

Line termination:

When longer runs of cable are used, you may need to use a terminator on the last unit to avoid erratic behaviour.

Using a cable terminator will decrease the possibilities of erratic behaviour.

(3-pin - Order ref: CABL90,
5-pin - Order ref: CABL89)

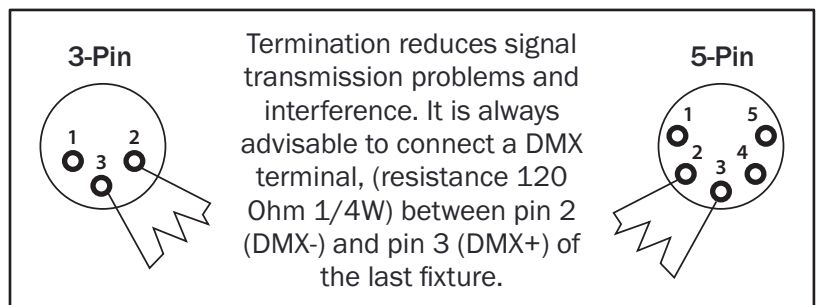

5-pin XLR DMX connectors:

Some manufactures use 5-pin XLR connectors for data transmission in place of 3-pin. 5-pin XLR fixtures may be implemented in a 3-pin XLR DMX line. When inserting standard 5-pin XLR connectors in to a 3-pin line a cable adaptor must be used. The diagram below details the correct cable conversion.

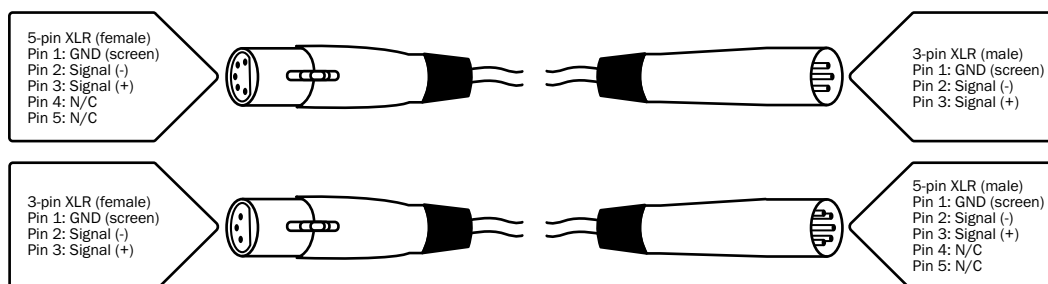

Power linking:

This fixture provides power linking via the power output on the rear allowing multiple units to be connected together. The maximum number of fixtures that can be connected is 10 fixtures @ 240V or 5 fixtures @ 120V (including the first fixture). After the maximum number of fixtures are connected a new power run will need to be started.

Please note: Caution should be used when power linking other fixtures to the Power Par 54 MKII as the power consumption of other fixtures will vary. LED fixtures fitted with switch mode power supplies often require 2/3 times more current on startup, these may require their own power source.

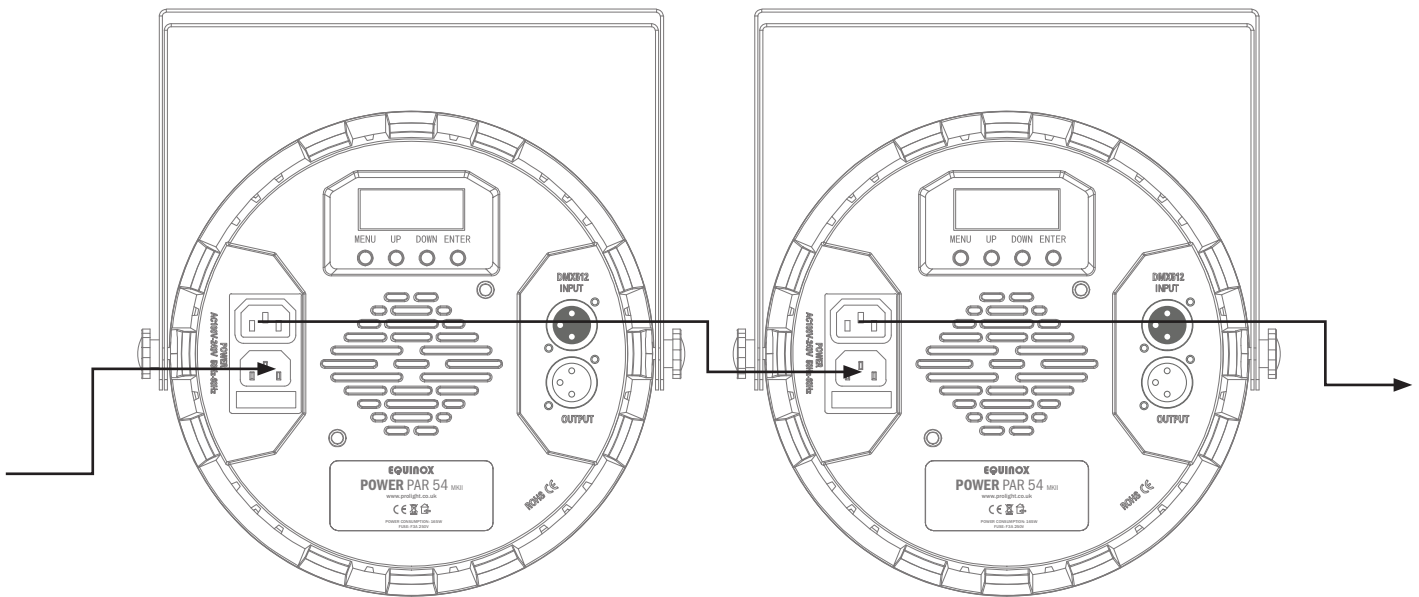



Correct Disposal of this Product (Waste Electrical & Electronic Equipment)

**(Applicable in the European Union and other European countries
with separate collection systems)**

This marking shown on the product or its literature, indicates that it should not be disposed of with other household wastes at the end of its working life. To prevent possible harm to the environment or human health from uncontrolled waste disposal, please separate this from other types of wastes and recycle it responsibly to promote the sustainable reuse of material resources.

Household users should contact either the retailer where they purchased this product, or their local government office, for details of where and how they can take this item for environmentally safe recycling.

Business users should contact their supplier and check the terms and conditions of the purchase contract. This product should not be mixed with other commercial wastes for disposal.

