

LEDj

Starlit Dance Floor User Manual

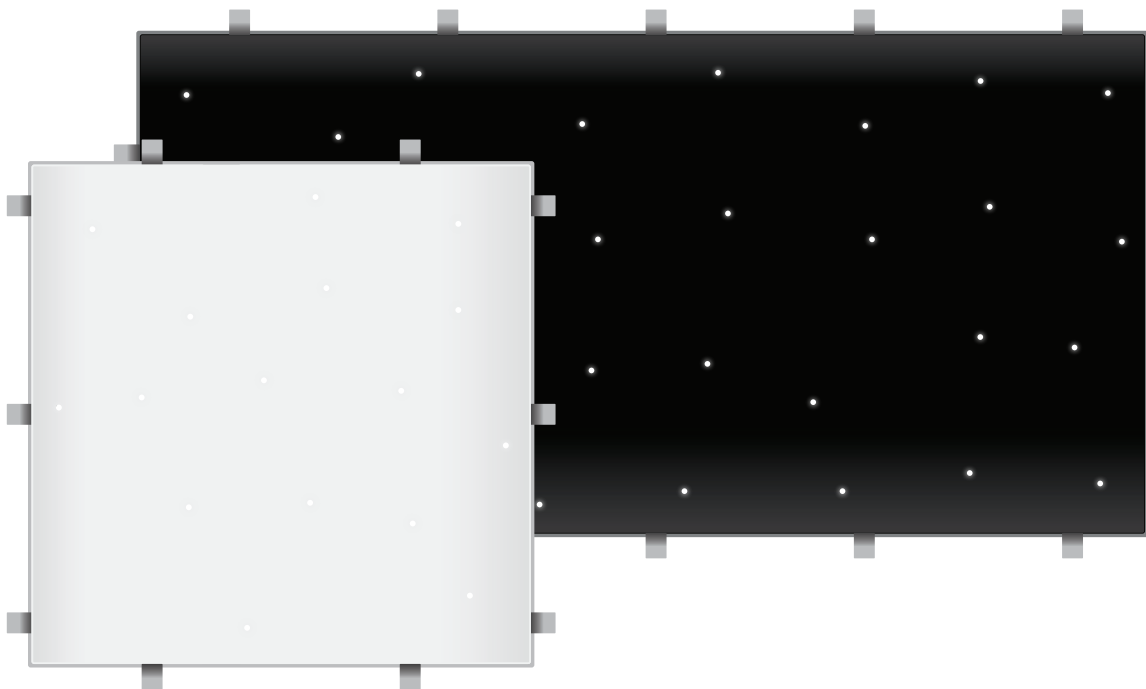

Order codes:

500W Power Supply - LEDJ405

750W Power Supply - LEDJ427

1000W Power Supply - LEDJ428

1500W Power Supply - LEDJ429

White Remote Control Pack - LEDJ406

White 2ft x 2ft Dance Floor Panel
(4 sided) - LEDJ400

White 2ft x 2ft Dance Floor Panel
(3 sided) - LEDJ400A

White 2ft x 4ft Dance Floor Panel - LEDJ401

Black 2ft x 2ft Dance Floor Panel
(4 sided) - LEDJ420

Black 2ft x 2ft Dance Floor Panel
(3 sided) - LEDJ420A

Black 2ft x 4ft Dance Floor Panel - LEDJ421

4ft Edge Trim - LEDJ402

4ft Edge Trim and Cable - LEDJ402A

2ft Edge Trim - LEDJ403

Corner Edge Trims (2 x L, 2 x R) - LEDJ404

RGB Remote Control Pack - LEDJ437

White RGB 2ft x 2ft Dance Floor Panel
(4 sided) - LEDJ431

White RGB 2ft x 2ft Dance Floor Panel
(3 sided) - LEDJ432

White RGB 2ft x 4ft Dance Floor Panel - LEDJ433

Black RGB 2ft x 2ft Dance Floor Panel
(4 sided) - LEDJ434

Black RGB 2ft x 2ft Dance Floor Panel
(3 sided) - LEDJ435

Black RGB 2ft x 4ft Dance Floor Panel - LEDJ436

WARNING FOR YOUR OWN SAFETY, PLEASE READ THIS USER MANUAL CAREFULLY BEFORE YOUR INITIAL START-UP!

- Before your initial start-up, please make sure that there is no damage caused during transportation.
- Should there be any damage, consult your dealer and do not use the equipment.
- To maintain the equipment in good working condition and to ensure safe operation, it is necessary for the user to follow the safety instructions and warning notes written in this manual.
- Please note that damages caused by user modifications to this equipment are not subject to warranty.



IMPORTANT:

The manufacturer will not accept liability for any resulting damages caused by the non-observance of this manual or any unauthorised modification to the equipment.

- Never let the power cable come into contact with other cables. Handle the power cable and all mains voltage connections with particular caution!
- Never remove warning or informative labels from the unit.
- Do not open the equipment and do not modify the unit.
- Do not connect this equipment to a dimmer pack.
- Do not switch the equipment on and off in short intervals, as this will reduce the system's life.
- Do not expose to flammable sources, liquids or gases.
- Do not install into damp environments.
- To prevent short circuits or fault conditions DO NOT use metallic confetti on or near the dance floor system(s).
- Always disconnect the power from the mains when equipment is not in use or before cleaning! Only handle the power-cable by the plug. Never pull out the plug by pulling the power-cable.
- Make sure that the available mains supply voltage is between 100~240V AC, 50/60Hz.
- Make sure that the power cable is never crimped or damaged. Check the equipment and the power cable periodically.
- If the equipment is dropped or damaged, disconnect the mains power supply immediately and have a qualified engineer inspect the equipment before operating again.
- If your product fails to function correctly, stop use immediately. Pack the unit securely (preferably in the original packing material), and return it to your Pro Light dealer for service.
- Only use fuses of same type and rating.
- Repairs, servicing and power connection must only be carried out by a qualified technician. For spare parts please contact sales@prolight.co.uk or phone 01254 704111. Edge contacts & LEDs may be deemed service parts and are not covered by the warranty.
- This lighting fixture is for professional use only - it is not designed for or suitable for household use. The product must be installed by a qualified technician in accordance with local territory regulations. The safety of the installation is the responsibility of the installer. The fixture presents risks of severe injury or death due to fire hazards, electric shock and falls.
- The LEDJ starlit dance floor systems are design to withstand human foot traffic only. Do not load the floor with heavy point loads such as truss or stand legs, also do not drive vehicles, flight cases or trolleys across the floor. Damage to the floor may occur and will not be covered by the manufacturers warranty.
- Caution warnings should be relayed to users of the floor who may wear shoes with small heels with regards to the floor joints & edges. The manufacturer does not carry any liability for slippage or falls with respect to loss of traction on the floor surface or interference with the joints and edges.
- Warning! Risk Group 2 LED product according to EN 62471. Do not view the light output with optical instruments or any device that may concentrate the beam.
- WARRANTY: One year from date of purchase.

OPERATING DETERMINATIONS

If this equipment is operated in any other way, than those described in this manual, the product may suffer damage and the warranty becomes void. Incorrect operation may lead to danger e.g: short-circuit, burns and electric shocks etc.

Do not endanger your own safety and the safety of others!

Incorrect installation or use can cause serious damage to people and/or property.

The dancefloor panels are designed to be installed on dry, stable surfaces. All installations must feature complete edge trim systems to reduce the risk of any trip hazards.

All components including locking mechanisms and electrical contacts should be carefully inspected each time before laying a starlit floor system. DO NOT assemble and lay a floor system if any components is worn or damaged. Replacement parts can be obtained from your local retailer or direct from Prolight Concepts.

The dancefloor system utilises custom edge connectors to transmit a safe, low voltage power feed from panel to panel.

Dancefloor Size (excluding edge trim)	2 x 2ft Panels			2ft x 4ft Panels	4ft Edge	4ft Edge with Power Cable	2ft Edge	Corners (Set of 4 2 x Left, 2 x Right)	PSU (one per system)	Remote Pack
	Total	4 Sided	3 Sided							
8x8ft	4	2	2	6	4	1	4	1	500W	1
10x10ft	5	3	2	10	7	1	2	1	500W	1
12x8ft	4	2	2	10	6	1	4	1	500W	1
10x12ft	6	3	3	12	8	1	4	1	500W	1
12x12ft	6	3	3	15	8	1	4	1	500W	1
14x12ft	6	3	3	18	9	1	4	1	500W	1
14x14ft	7	4	3	21	11	1	2	1	500W	1
16x14ft	6	3	3	25	11	1	4	1	500W	1
16x16ft	8	4	4	28	12	1	4	1	500W	1
18x14ft	7	4	3	28	13	1	2	1	500W	1
18x16ft	8	4	4	32	13	1	4	1	500W	1
18x18ft	9	5	4	36	15	1	2	1	500W	1
20x16ft	8	4	4	36	14	1	4	1	500W	1
20x18ft	8	4	4	41	15	1	4	1	500W	1
20x20ft	10	5	5	45	15	2	4	1	500W	1
22x16ft	8	4	4	40	14	2	4	1	500W	1
22x18ft	9	5	4	45	16	2	2	1	500W	1
24x18ft	8	4	4	50	16	2	4	1	500W	1
22x20ft	10	5	5	50	16	2	4	1	500W	1
22x22ft	11	6	5	55	18	2	2	1	500W	1
24x20ft	10	5	5	55	17	2	4	1	500W	1
24x22ft	10	5	5	61	18	2	4	1	500W	1
24x24ft	12	6	6	66	19	2	4	1	500W	1
26x20ft	10	5	5	60	18	2	4	1	500W	1
26x22ft	11	6	5	66	20	2	2	1	500W	1
26x24ft	12	6	6	72	20	2	4	1	750W	1
26x26ft	13	7	6	78	22	2	2	1	750W	1
28x24ft	12	6	6	78	21	2	4	1	750W	1
28x26ft	12	6	6	85	22	2	4	1	750W	1
28x28ft	14	7	7	91	23	2	4	1	750W	1
30x26ft	13	7	6	91	24	2	2	1	750W	1
30x28ft	14	7	7	98	24	2	4	1	750W	1
30x30ft	15	8	7	105	26	2	2	1	750W	1
32x32ft	16	8	8	120	30	4	4	1	1000W	1
32x34ft	16	8	8	128	26	4	4	1	1000W	1
34x34ft	17	9	8	136	28	4	2	1	1000W	1
36x36ft	18	9	9	153	29	4	4	1	1000W	1
40x40ft	20	10	10	190	33	4	4	1	1500W	1

Order code	Description
LEDJ400	White 2ft x 2ft Dance Floor Panel (4 sided) (White LED Version)
LEDJ400A	White 2ft x 2ft Dance Floor Panel (3 sided) (White LED Version)
LEDJ401	White 2ft x 4ft Dance Floor Panel (White LED Version)
LEDJ420	Black 2ft x 2ft Dance Floor Panel (4 sided) (White LED Version)
LEDJ420A	Black 2ft x 2ft Dance Floor Panel (3 sided) (White LED Version)
LEDJ421	Black 2ft x 4ft Dance Floor Panel (White LED Version)
LEDJ431	White 2ft x 2ft Dance Floor Panel (4 sided) (RGB LED Version)
LEDJ432	White 2ft x 2ft Dance Floor Panel (3 sided) (RGB LED Version)
LEDJ433	White 2ft x 4ft Dance Floor Panel (RGB LED Version)
LEDJ434	Black 2ft x 2ft Dance Floor Panel (4 sided) (RGB LED Version)
LEDJ435	Black 2ft x 2ft Dance Floor Panel (3 sided) (RGB LED Version)
LEDJ436	Black 2ft x 4ft Dance Floor Panel (RGB LED Version)
LEDJ405	500W Power Supply
LEDJ427	750W Power Supply
LEDJ428	1000W Power Supply
LEDJ429	1500W Power Supply
LEDJ402	4ft Edge Trim
LEDJ402A	4ft Edge Trim with cable
LEDJ403	2ft Edge Trim
LEDJ404	Corner Edge Trims (2 x L, 2 x R)
LEDJ406	Remote Control Pack (White Starlit Dancefloors)
LEDJ437	Remote Control Pack (RGB Starlit Dancefloors)

Starlit Dance Floor

The LEDJ portable, starlit dance floors use crisp cool white or RGB LEDs inset into high gloss, interlocking panels. Constructed using a rugged aluminium chassis, each panel is finished with a glossy, acrylic upper panel giving a sprung feel while remaining fully supported. Each panel features 16 (2ft x 2ft) or 32 (2ft x 4ft) SMD white/RGB LEDs with modes including full on and adjustable rate flash/twinkle. Ideal for use in venues for events such as weddings, parties and corporate evenings. Scalable in size, the system uses a combination of 4 x 2ft and 2 x 2ft panels finished with sloped aluminium edge trim.

- High gloss, interlocking panels
- Cool white or RGB LEDs
- Aluminium edge trim
- High quality, Meanwell SMPSU
- RF remote control with static and adjustable rate flash and twinkle

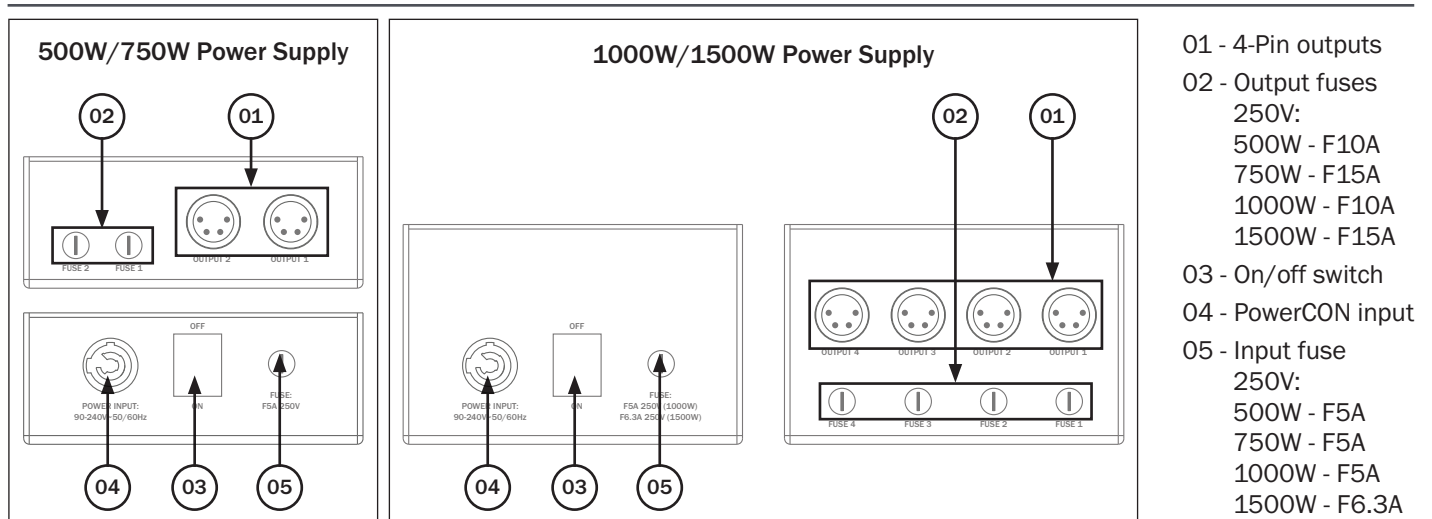
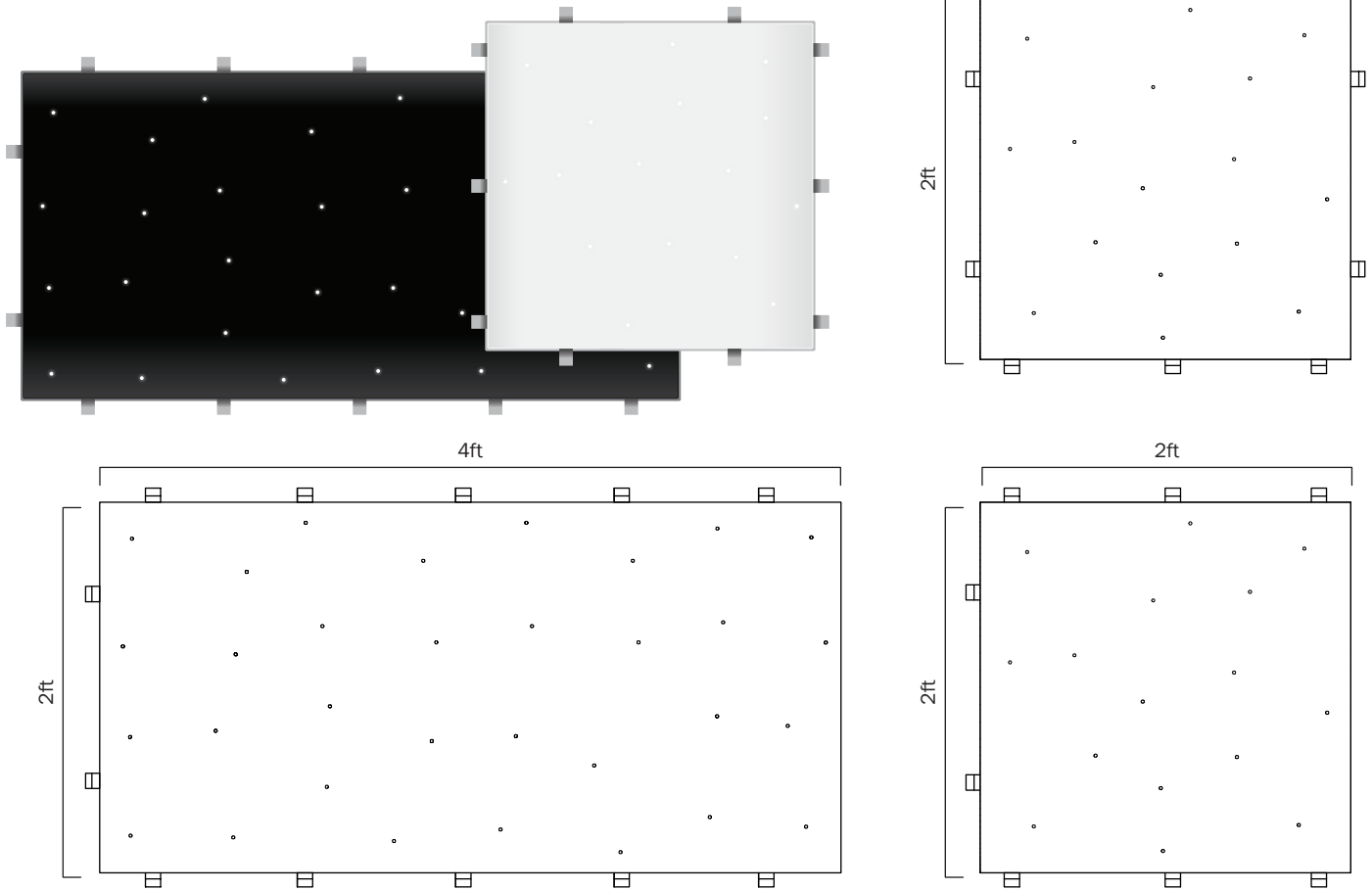

Panel locking mechanism:

The panels each lock together using a special locking mechanism. Lay the first panel flat on the floor in the orientation shown below. Hold the second panel at an angle as shown in the diagram and push towards the first panel allowing the aluminium lugs to locate. When the two panels are fully touching along their edges, lower the panel to the floor. If the panels are not square, or if the edges are not fully touching the panel being fitted will not lower. **DO NOT FORCE THE PANELS DOWN!** Simply adjust the alignment until the panel will lower to the floor.

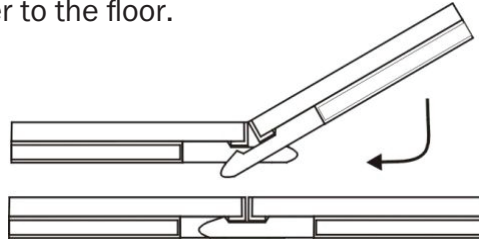

Detailed laying instructions:

Row 1:

Start at the top left hand corner position by placing a full panel (2ft x 4ft) with the 2 end lugs pointing to the right. Please ensure you leave space to add the edge trim between the dancefloor and any immovable objects such as walls or staging.

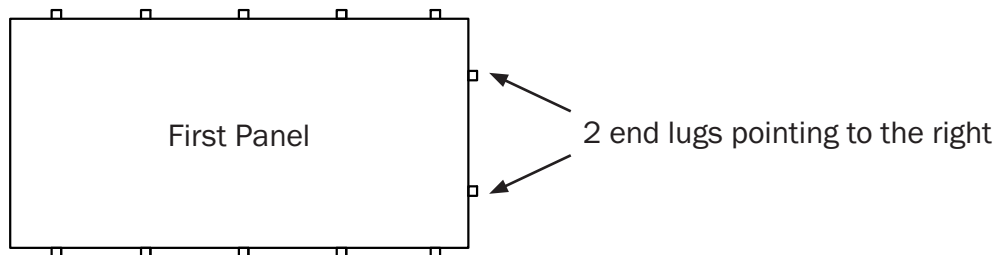

Lay a second panel with the 2 end lugs also pointing to the right.

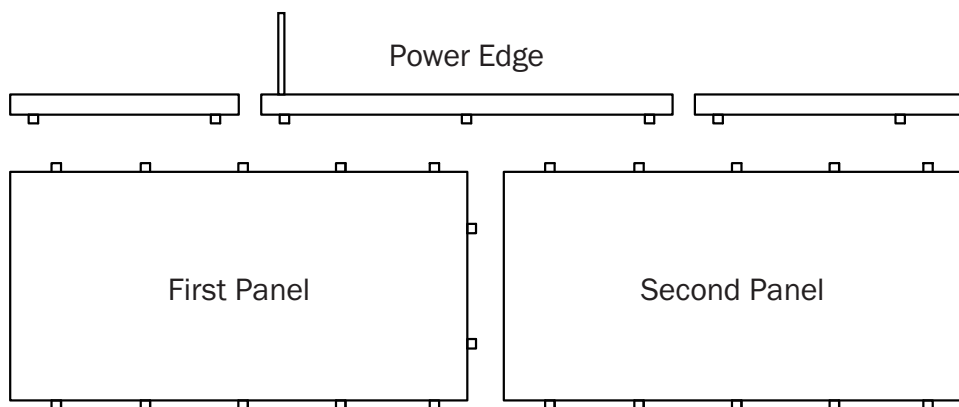

Continue to lay the row with as many full panels as required for the size of floor required, add onto the end of this row a three sided half panel if required. Take great care to ensure the panels are aligned flush along the length of the row to ensure the edging will be straight. After completing the first row of panels, fit the edging to this row before continuing to lay the second row.

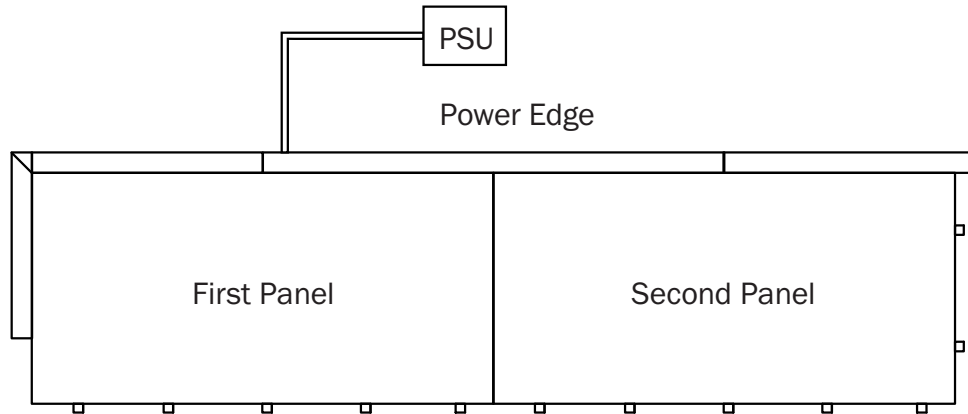

The first row of edging should include the appropriate number of 4ft edge strips with power connection depending on the floor size (see component cross reference chart on page 3). When selecting the power supply, please consult the chart included in this user guide. Up to (and including) 24ft x 24ft floor systems require a 500W power supply. Systems 26ft x 26ft up to 30ft x 30ft use a 750W power supply. Dancefloor systems over 32ft x 32ft require a 1000W power supply. Systems 40ft x 40ft and over require a 1500W power supply.

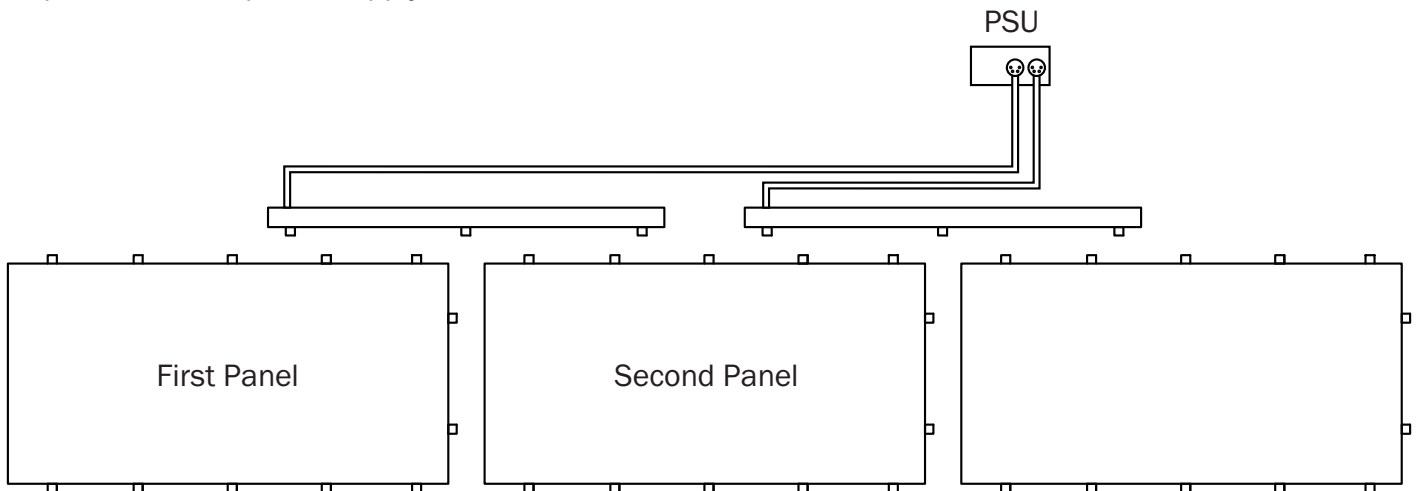

CAUTION: Care should be taken to ensure the power connection between each floor panel is correctly aligned. Failure to do so may result in an open or short circuit fault condition.

Row 2:

Begin row 2 at the left hand side with a four sided half panel (2ft x 2ft) and the 2 end lugs pointing left. Continue with full panels ensuring all panels are laid with the 2 end lugs pointing to the right. Complete the row with another half panel. To prevent slippage or movement on smooth surfaces, a second person may be required to help secure the first row of panels while the second row is laid.

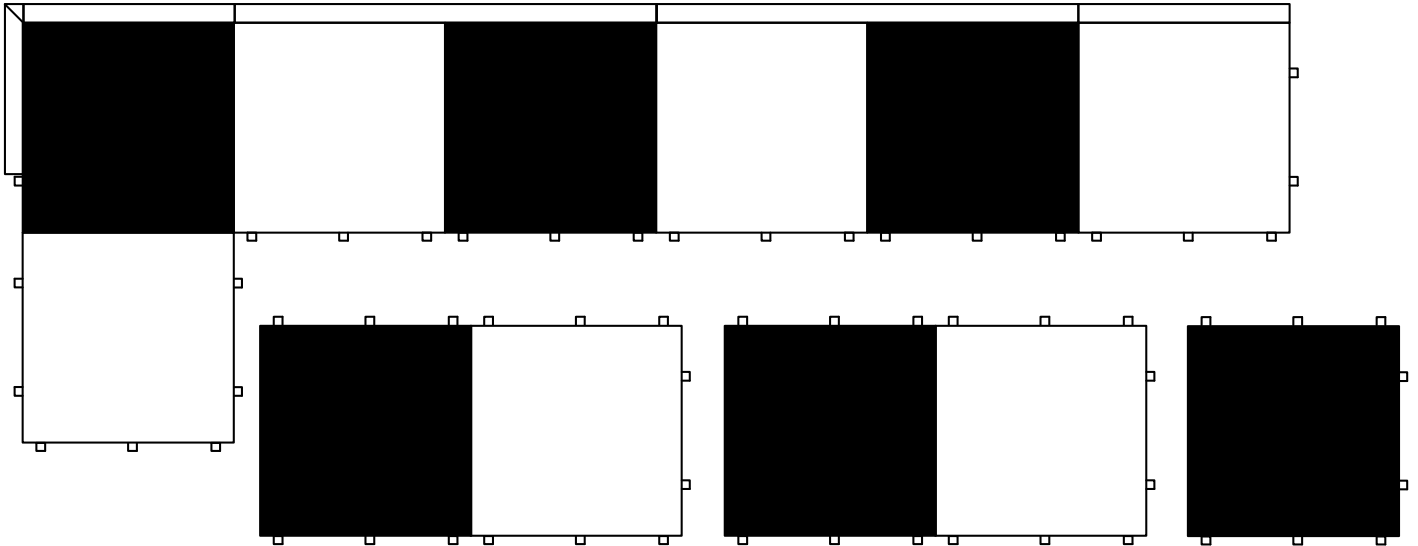

Edging:

Start to lay the edging when row one is completed, the edging then acts as a straight edge and ensures each row is square and flush as it is laid.

Fit the edging by pushing the lugs underneath the panels at an angle, and then fit them lower to the floor, in the same way as laying the panels. **DO NOT FORCE THE EDGING DOWN!** Half length and full length edges are supplied so that the panel joints and edging joints never coincide, i.e they follow the same brickwork type pattern.

Row 3:

Lay with full panels the same as row 1.

Fitting the corner:

Corners are always positioned on the side of the floor as shown and never the top or bottom.

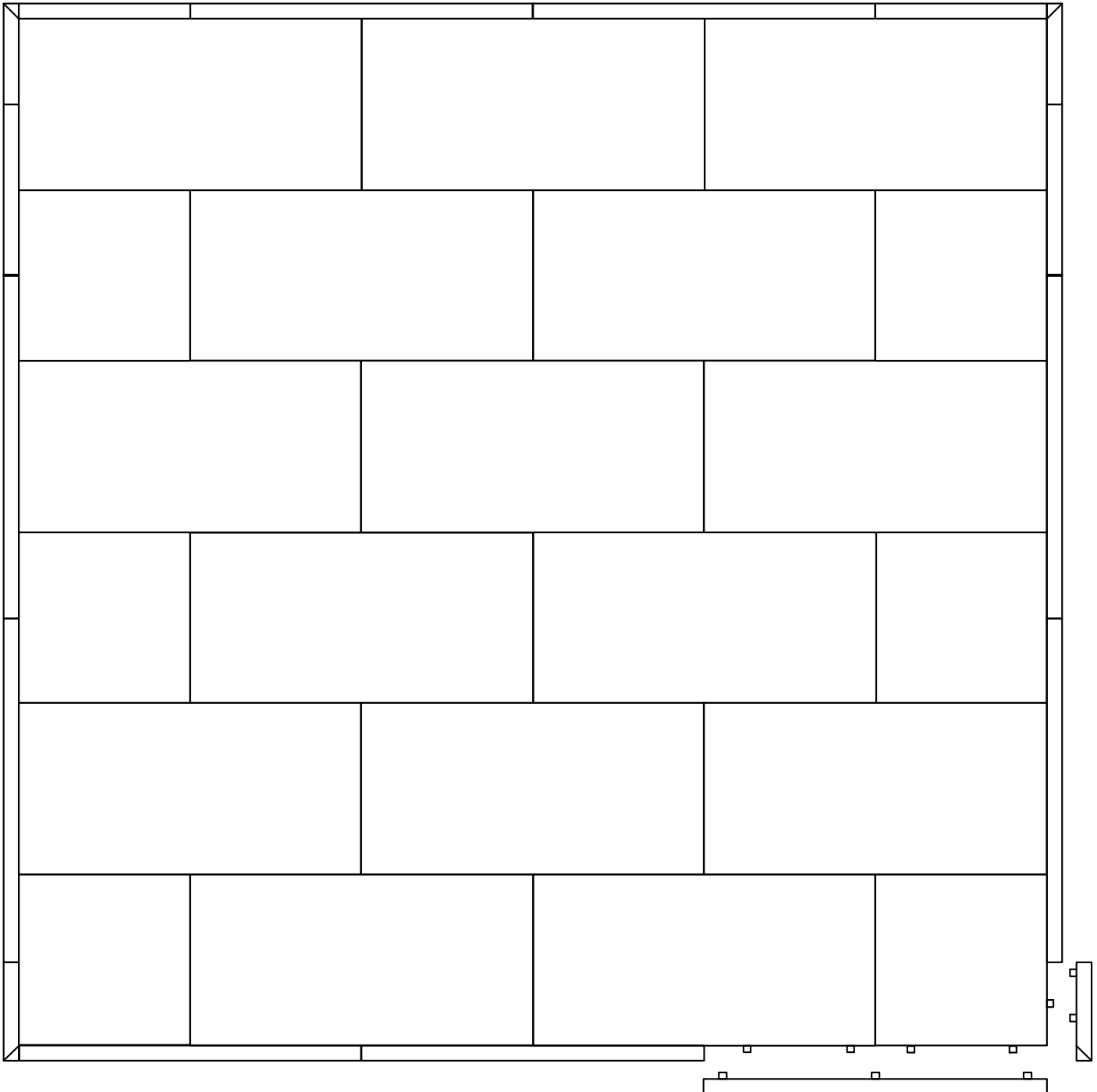

Two corner pieces always on the same edge and always positioned on the same side.

Remote Control (White Starlit Dancefloor):

Connect the receiver unit to a suitable power source and power on. Ensure the handheld remote is fitted with a good quality battery (A23 12V Alkaline). Press the correct button as per the list below to select the required mode of operation.

Button A – Full On

Button B – Blackout

Button C – Twinkle speed increase

Button D – Twinkle speed decrease

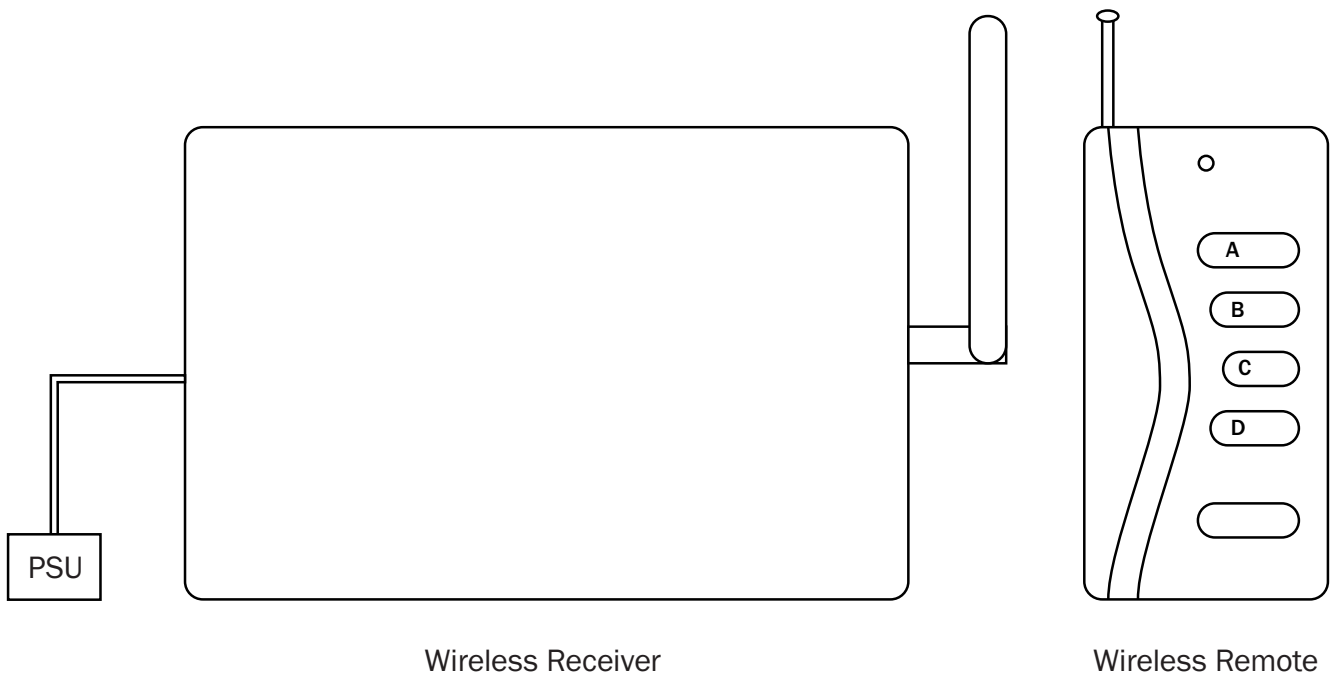

Remote Control (RGB Starlit Dancefloor):

Connect the receiver unit to a suitable power source and power on. Ensure the handheld remote is fitted with a good quality battery (A23 12V Alkaline). Press the correct button as per the list below to select the required mode of operation.

Button 1 - Red

Button 2 - Green

Button 3 - Blue

Button 4 - Yellow

Button 5 - Magenta

Button 6 - Cyan

Button 7 - White

Button 8 - Twinkle

(adjustable via speed)

Button 9 - Programs

(see chart below)

Button 10 - Speed decrease

Button 11 - Speed increase

Button 12 - Reset

Button 13 - Brightness decrease

Button 14 - Brightness increase

Button 15 - Blackout

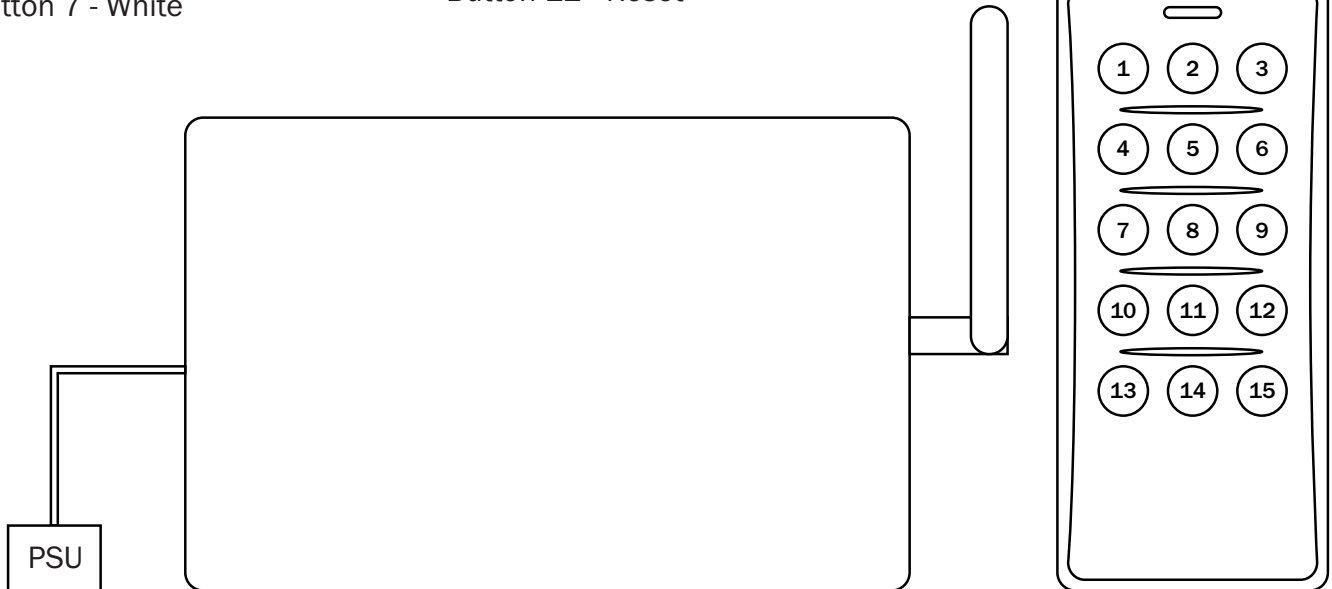

Wireless Receiver

Wireless Remote

Program 1 (Buttons 1 & 9) - Red & Green twinkle
Program 2 (Buttons 2 & 9) - Blue & Green twinkle
Program 3 (Buttons 3 & 9) - Red & Blue twinkle
Program 4 (Buttons 4 & 9) - Red, Green & Blue auto
Program 5 (Buttons 5 & 9) - Red, Green & Blue fade
Program 6 (Buttons 6 & 9) - Red & Blue fade
Program 7 (Buttons 7 & 9) - 7 colour fade



***Correct Disposal of this Product
(Waste Electrical & Electronic Equipment)***

**(Applicable in the European Union and other European countries
with separate collection systems)**

This marking shown on the product or its literature, indicates that it should not be disposed of with other household wastes at the end of its working life. To prevent possible harm to the environment or human health from uncontrolled waste disposal, please separate this from other types of wastes and recycle it responsibly to promote the sustainable reuse of material resources.

Household users should contact either the retailer where they purchased this product, or their local government office, for details of where and how they can take this item for environmentally safe recycling.

Business users should contact their supplier and check the terms and conditions of the purchase contract. This product should not be mixed with other commercial wastes for disposal.

