

LSR II SP

POWERED 15" SUBWOOFER

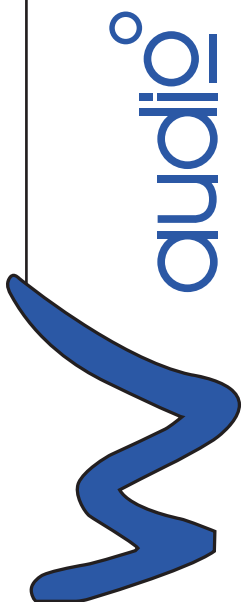

Order Code: SPEA48

www.prolight.co.uk

USER MANUAL

ENGLISH

WARNING

**FOR YOUR OWN SAFETY, PLEASE READ THIS USER MANUAL CAREFULLY
BEFORE YOUR INITIAL START-UP!**

Unpacking Instructions

Immediately upon receiving this product, carefully unpack the carton and check the contents to ensure that all the parts are present, and have been received in good condition. Notify the dealer immediately and retain the packaging material for inspection if any parts appear damaged from shipping or the carton itself shows signs of mishandling. Save the carton and all packaging materials. In the event that a product must be returned to the supplier, it is important that the equipment is returned in the original carton and packaging.



CAUTION!

**Keep this equipment away from rain,
moisture and liquids.**



SAFETY INSTRUCTIONS

Every person involved with the installation, operation & maintenance of this equipment should:

- Be competent
- Follow the instructions of this manual



DANGER OF BURNING!

**The materials used in this speaker system are easily flammable.
If B1 is required at the installation place, the surface must be treated with an
appropriate fire retardant at regular intervals.**



DANGER TO LIFE!

**A falling speaker system can cause deadly accidents. All safety instructions
given in this manual must be observed.**



**CAUTION! TAKE CARE USING THIS EQUIPMENT!
HIGH VOLTAGE-RISK OF ELECTRIC SHOCK!!**



IMPORTANT:

The manufacturer will not accept liability for any resulting damages caused by the non-observance of this manual or any unauthorised modification to the equipment.

- Never let the power-cable come into contact with other cables. Handle the power-cable and all mains voltage connections with particular caution!
- Never remove warning or informative labels from the equipment.
- Do not open the equipment and do not modify the equipment.
- Do not switch the equipment on and off in short intervals, as this will reduce the system's life.
- Only use the equipment indoors.
- Do not expose to flammable sources, liquids or gases.
- Always disconnect the power from the mains when equipment is not in use or before cleaning! Only handle the power-cable by the plug. Never pull out the plug by pulling the power-cable.
- Make sure that the available voltage is between 220V-240V.
- Make sure that the power-cable is never crimped or damaged. Check the equipment and the power-cable periodically.
- If the equipment is dropped or damaged, disconnect the mains power supply immediately. Have a qualified engineer inspect the equipment before operating again.
- If the equipment has been exposed to drastic temperature fluctuation (e.g. after transportation), do not switch it on immediately. The arising condensation might damage the equipment. Leave the equipment switched off until it has reached room temperature.
- If your product fails to function correctly, discontinue use immediately. Pack the unit securely (preferably in the original packing material), and return it to your Prolight dealer for service.
- Only use fuses of same type and rating.
- Repairs, servicing and power connection must only be carried out by a qualified technician. **THIS UNIT CONTAINS NO USER SERVICEABLE PARTS.**
- **WARRANTY;** One year from date of purchase.
- W Audio products are designed and intended for professional use only by competent persons. The products are not suitable for domestic use.

OPERATING DETERMINATIONS

If this equipment is operated in any other way, than those described in this manual, the product may suffer damage and the warranty becomes void.

Incorrect operation may lead to danger e.g.: short-circuit, burns, electric shocks etc.

Do not endanger your own safety and the safety of others!

Incorrect installation or use can cause serious damage to people and property.

Please note that speaker systems can move due to bass beats and vibrations. Furthermore, unintended pushing on the speakers present a further risk. The speaker system must always be secured against moving or the respective area has to be blocked.

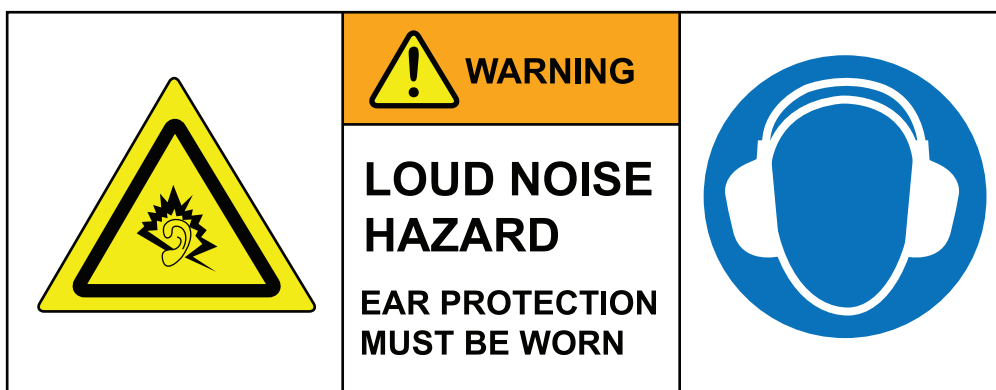

Unpacking and transportation:

Unpack the unit and examine them for transport damage.

When boxed in the original packaging the speaker system should be carried by two persons of the same size. Carrying the speaker system with one person alone should be avoided as the heavy weight and strain could lead to back injury. Please note that all speaker systems weighing more than 25kg must be transported by two persons.



When operating the speaker system, please make sure that the system always sounds clear. When distortion can be heard, either the amplifier or the loud speaker is being overdriven. Overloads can quickly lead to amplifier or speaker damage. In order to avoid damage, please reduce the volume immediately when distortion can be heard. When speaker systems are damaged by overdriving, the guarantee becomes void.

The ambient temperature must always be between -5° C and +45° C. Keep away from direct sunlight (particularly in cars) and from heaters.

The relative humidity must not exceed 50% with an ambient temperature of +45° C.

This speaker system must only be installed at a solid, horizontal, anti-slip, vibration and oscillation free fire resistant location.

Please note: When using this speaker system in public or industrial areas, a series of safety instructions have to be followed that this manual can only give in part. The operator must therefore inform himself on the current safety regulations.

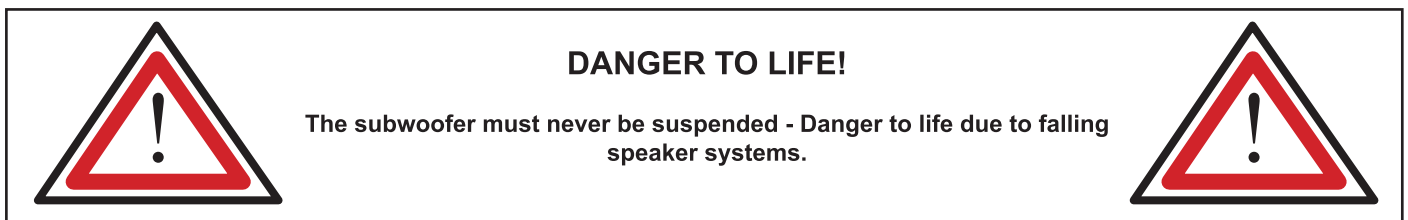

Please note: W Audio cannot be made liable for damages caused by incorrect installations and excessive noise levels.

Subwoofer features:

- Amplifier output power: 1 x 650W RMS
- Speaker output power: 500W RMS
- Maximum SPL (1m): 127dB
- Frequency response (-10dB): 40Hz-180Hz
- Frequency response (-3dB): 45Hz-160Hz
- Internal low pass crossover frequency: 80Hz-180Hz adjustable
- Low frequency transducer: 15"/381mm
- Mid/top speaker amplifier connections: 2 x XLR inputs, 2 x XLR outputs and 2 x RCA inputs
- Fitted with M20 sub/sat pole mount (35mm)
- Supplied with padded transit bag
- Recessed handles
- Heavy duty grille
- Power consumption: 900W
- Power supply: 220-240V~50/60Hz
- Dimensions: 585x 550 x 450mm (L x W x H)
- Weight: 40kg

Overview:

Sub amplifier:

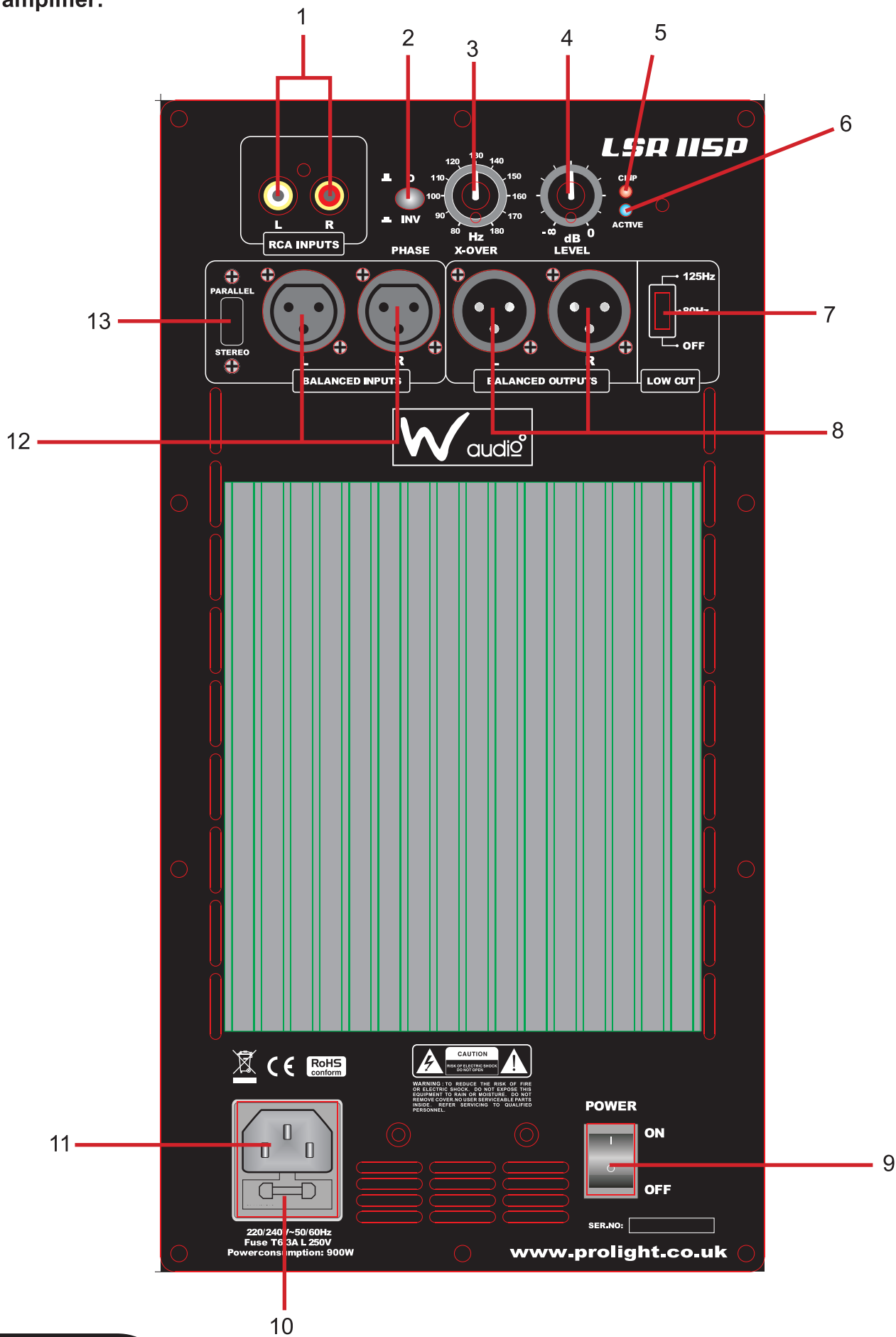

1. **RCA Inputs L/R:** Use these RCA inputs to connect your audio mixer.
2. **Phase selector:** Switch reverses output phase to compensate for frequency cancellation between subwoofers room acoustics of subwoofer placement.
3. **Subwoofer low pass crossover frequency:** The LSR 115P can be adjusted to suit the system configuration and room acoustics.
4. **Subwoofer bass level control:** Controls input gain. Turn clockwise to increase the input gain.
5. **Subwoofer Clip Indicator LED:** This LED flashes when the input signal is too high, reduce input level to the system.
6. **Active Indicator LED:** This LED illuminates when the unit is switched on.
7. **Low Cut selector:** Selectable (OFF / 80Hz / 125Hz) low frequency cut off for balanced XLR outputs
8. **Balanced Outputs:** Stereo balanced line outputs suitable for linking to extra Subwoofer or mid/hi speakers.
9. **On/Off Switch:** Mains power on/off for the system. Connections for signal input and speaker outputs must be made before powering on the system.
10. **Fuse:** T6.3A L 250V
11. **IEC Mains Inlet:** Connect the LSR 115P to the mains using the supplied 13A BS1363 IEC power cord. Care should be taken to ensure the mains outlet voltage is AC 220-240V~50/60Hz.
12. **Balanced Inputs:** Stereo balanced line inputs suitable for input from a mixing console.
13. **Parallel/Stereo selector:** Selects between the parallel mode and stereo mode. If using the subwoofer with a single mono input signal the subwoofer should be switched to parallel.

Stereo system with one LSR 115P:

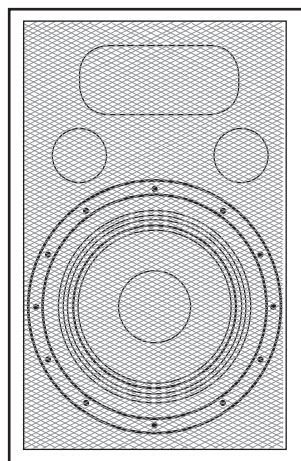

PSR 8A
DSR 12A
DSR 15A

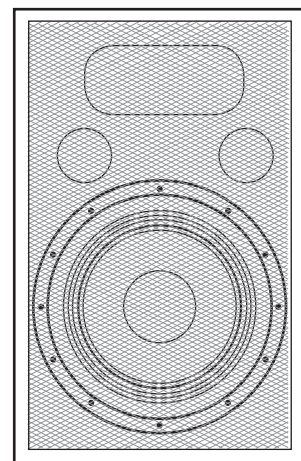

PSR 8A
DSR 12A
DSR 15A

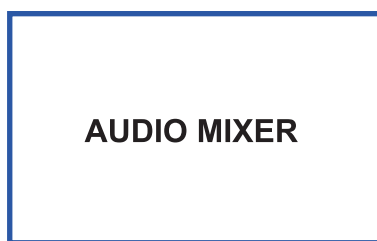

AUDIO MIXER

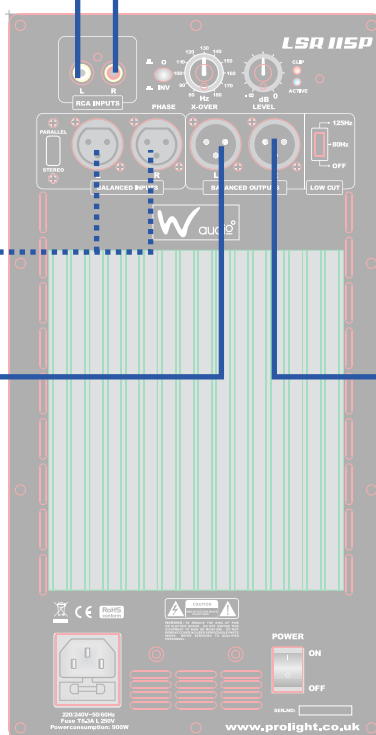
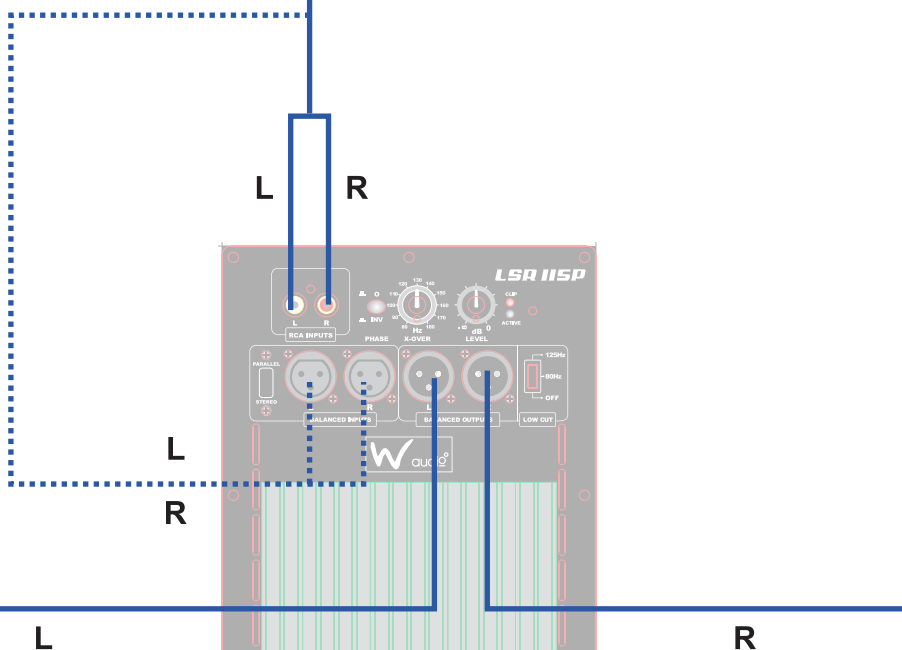

LSR 115P

- 80Hz or 125Hz high pass filter activated
- Subwoofer in stereo mode

Stereo system with two LSR 115P and two active mid/hi cabinets:

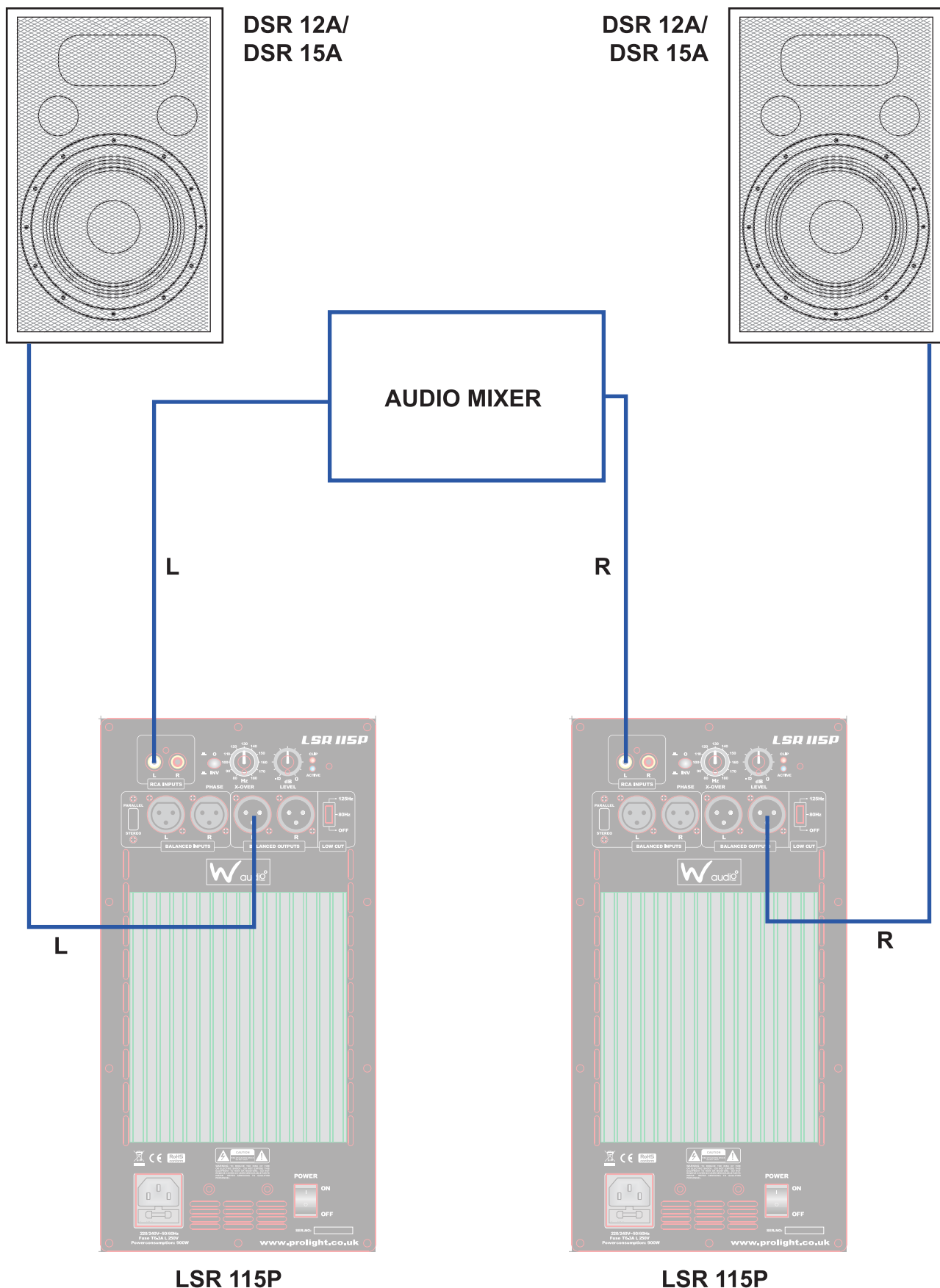

LSR 115P

LSR 115P

- 80Hz or 125Hz high pass filter activated
- Subwoofer in parallel mode

Add sub to existing system:

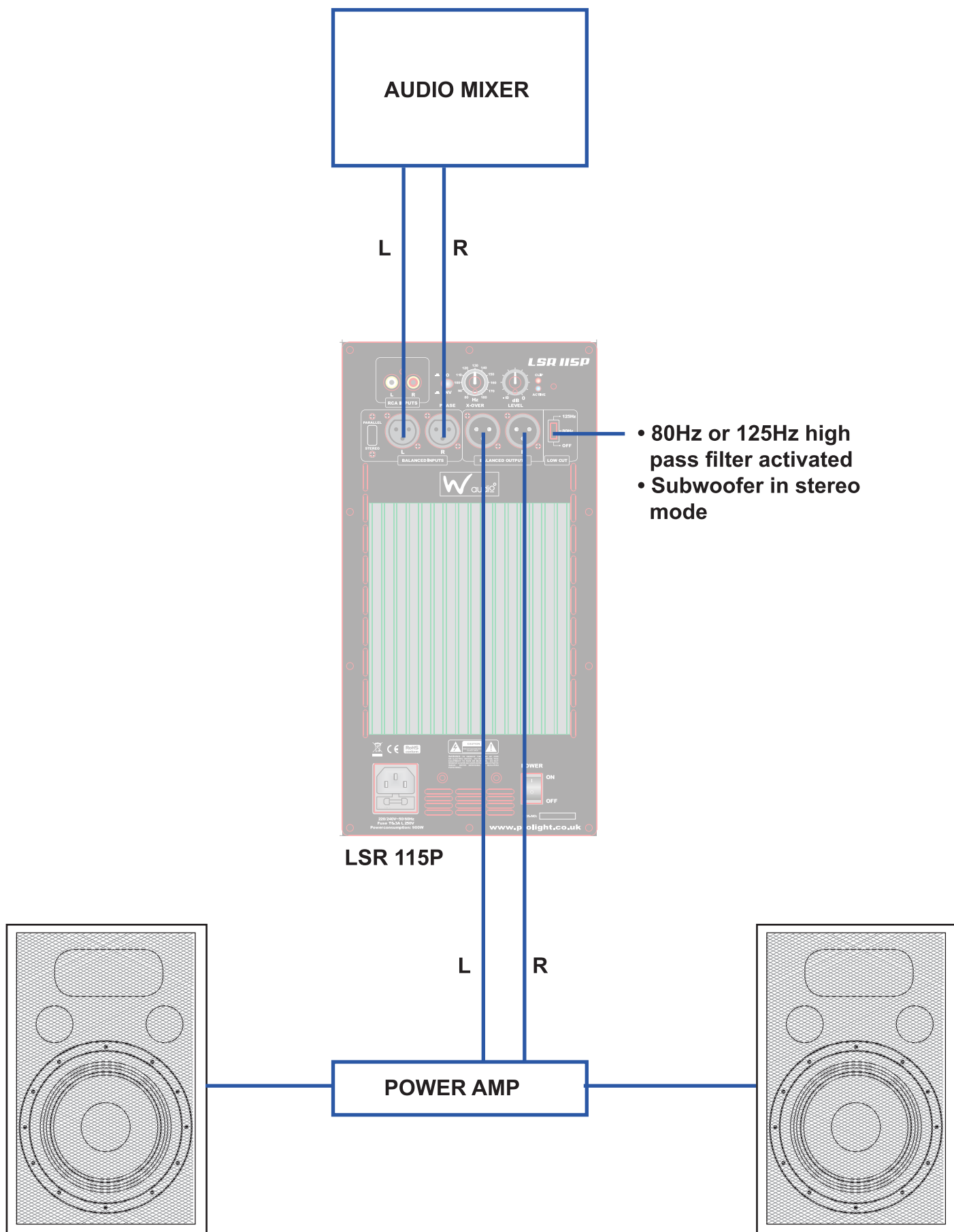

Add Aux fed subwoofers complimenting existing systems:

Main PA System

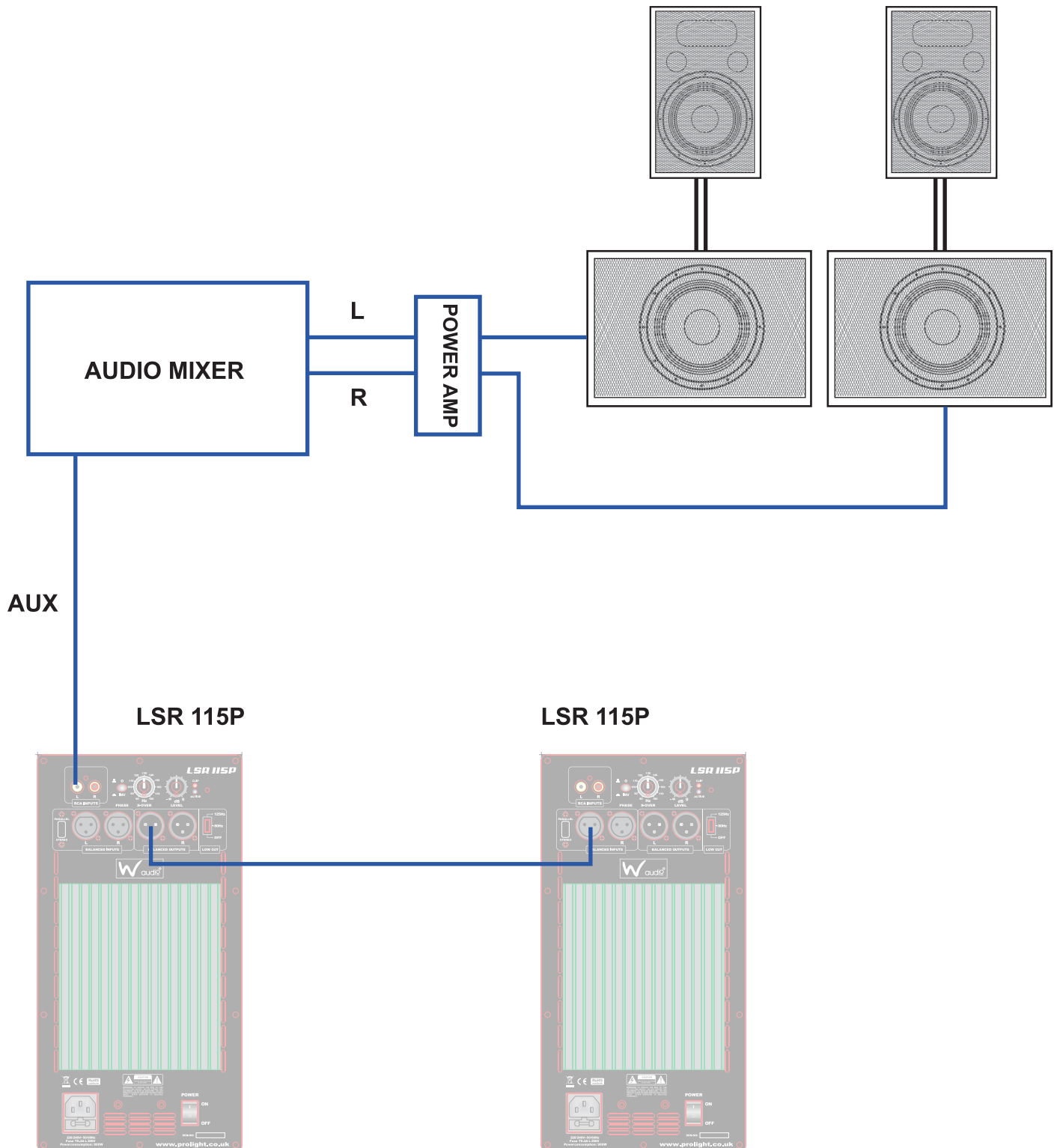

- 80Hz or 125Hz high pass filter off
- Subwoofer in parallel mode

- Subwoofer in parallel mode

Start Up

Place the subwoofer to the desired installation area and carefully turn it onto its feet.

Make sure that the power switch is set to “OFF” before you connect the speakers.

Inputs

This speaker system is to be directly connected to the outputs of your audio mixer or keyboard etc.

A good quality cable run improves the sound quality considerably. Input cables should be short and direct, since high frequencies may be absorbed if the cables are unnecessarily long. Also a longer cable may lead to humming and noise problems. If long cables runs are unavoidable, you should use balanced cables.

In order to obtain the highest sound quality, only use high quality cables for connecting the units.

The LSR 115P Subwoofer can be connected via balanced XLR and RCA sockets for line level inputs and balanced XLR sockets for speaker outputs

Always connect the left and right channels for stereo operation, or activate the parallel switch if connecting a mono signal to the LSR 115P.

Balanced XLR Connection

Connection With The Mains

Connect the unit to the mains via the IEC mains inlet using the 13A UK - IEC cord supplied.

The earth has to be connected.

Switch the unit on. After switching on the speaker system, wait 8 - 10 seconds before you turn the volume control up in order to avoid speaker damage.

CAUTION! Increase the level of each channel up to the point where the clip LEDs illuminate.

Always check the sound pressure level with a meter in order to keep to the legal threshold.

Installing the speaker cables

Always treat the cables carefully and protect them from damage during transportation.

Always install the cables in a structured way and protect them from damage.

The cables must be installed in a way that no person can trip over them. Always fix the cables with an appropriate tape etc.

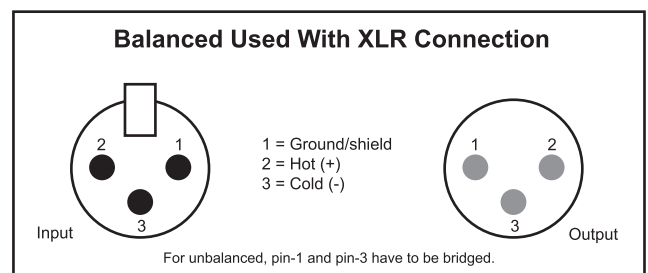

Installation

Stacking

This speaker system may only be installed on top of another speaker system if both systems are clamped up to each other via appropriate clamping belts and protected against tilting over.

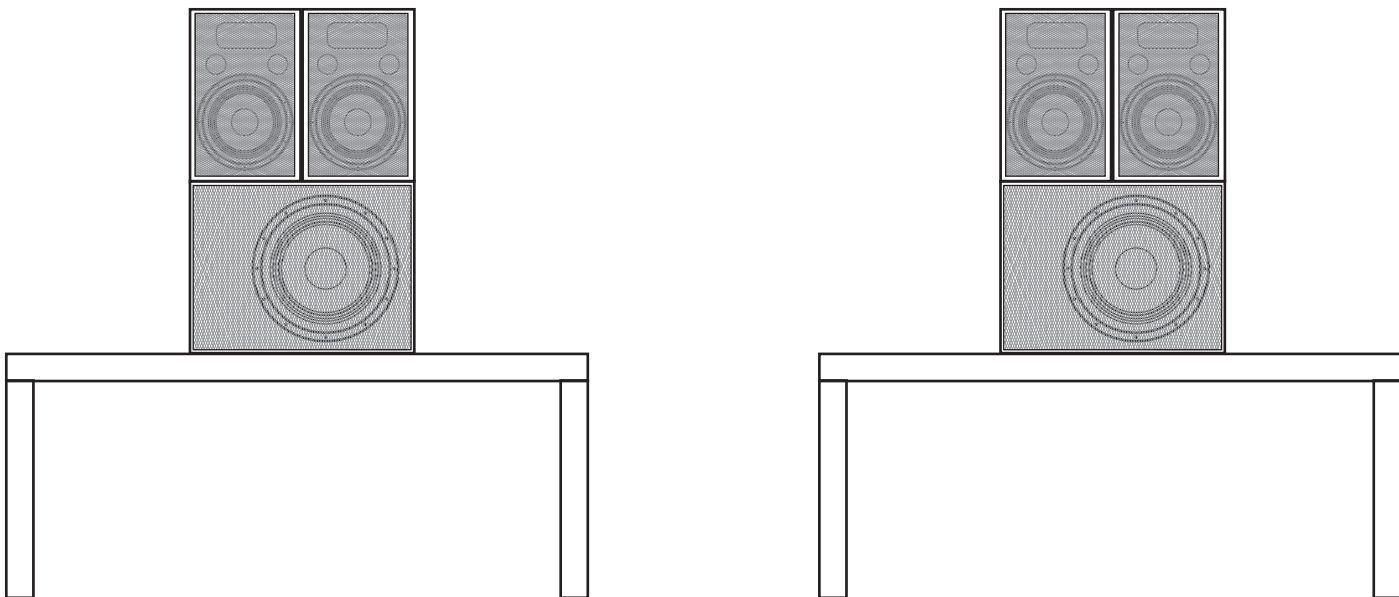

Satellite System

The satellite system must always provide enough stability. The subwoofer's base surface must always be sufficiently dimensioned in relation to the top speaker in order to prevent tilting over.

The subwoofer and the top speaker must only be connected via an appropriate extension pole and stand adaptor (STAN36).

The carrying capacity of the distance tube must never be exceeded.

When choosing the installation location, please make sure no person can enter the area below the system! Make sure that the respective area is blocked.

An unintended movement of the load has to be avoided - also in case of fire!

The system must never be moved before the top speaker has been removed.

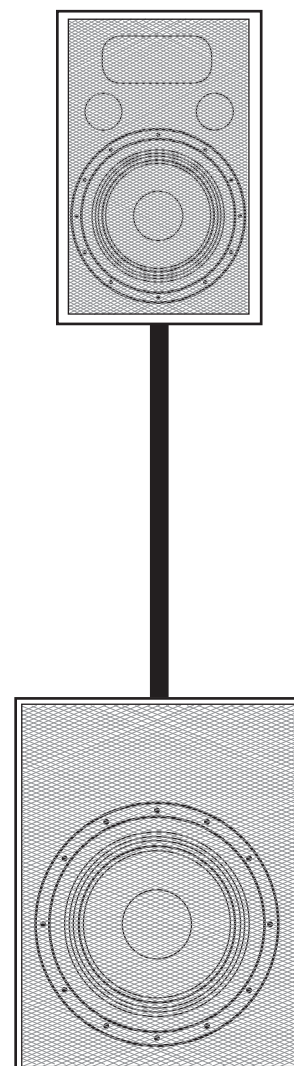

Notes:



Notes:

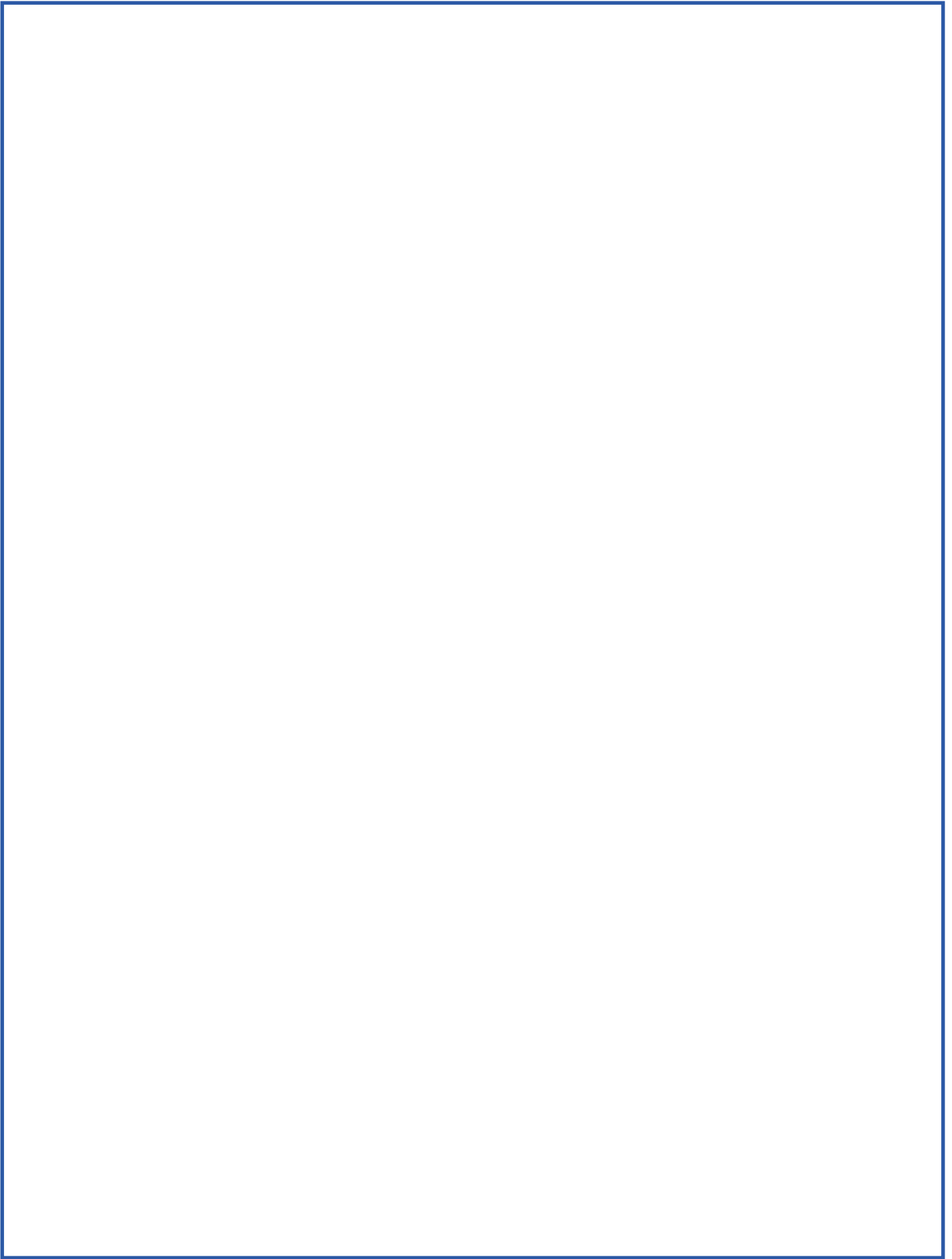

English



**Correct Disposal of this Product
(Waste Electrical & Electronic Equipment)**

(Applicable in the European Union and other European countries with separate collection systems)

This marking shown on the product or its literature, indicates that it should not be disposed with other household wastes at the end of its working life. To prevent possible harm to the environment or human health from uncontrolled waste disposal, please separate this from other types of wastes and recycle it responsibly to promote the sustainable reuse of material resources.

Household users should contact either the retailer where they purchased this product, or their local government office, for details of where and how they can take this item for environmentally safe recycling.

Business users should contact their supplier and check the terms and conditions of the purchase contract. This product should not be mixed with other commercial wastes for disposal.

