

EQUIN X

GEMINI

Order code: EQLA13



user manual

WARNING

**FOR YOUR OWN SAFETY, PLEASE READ THIS USER MANUAL CAREFULLY
BEFORE YOUR INITIAL START-UP!**

**CAUTION!**

**Keep this equipment away from rain,
moisture and liquids.**

**SAFETY INSTRUCTIONS**

Every person involved with the installation, operation & maintenance of this equipment should:

- Be competent
- Follow the instructions of this manual



**CAUTION! TAKE CARE USING THIS EQUIPMENT!
HIGH VOLTAGE-RISK OF ELECTRIC SHOCK!!**



Before your initial start-up, please make sure that there is no damage caused during transportation. Should there be any, consult your dealer and do not use the equipment.

To maintain the equipment in good working condition and to ensure safe operation, it is necessary for the user to follow the safety instructions and warning notes written in this manual.

Please note that damages caused by user modifications to this equipment are not subject to warranty.

IMPORTANT:

The manufacturer will not accept liability for any resulting damages caused by the non-observance of this manual or any unauthorised modification to the equipment.

- Never let the power-cable come into contact with other cables. Handle the power-cable and all mains voltage connections with particular caution!
- Never remove warning or informative labels from the equipment.
- Do not open the equipment and do not modify the equipment.
- Do not connect this equipment to a dimmer-pack.
- Do not switch the equipment on and off in short intervals, as this will reduce the system's life.
- Only use the equipment indoors.
- Do not expose to flammable sources, liquids or gases.
- Always disconnect the power from the mains when equipment is not in use or before cleaning! Only handle the power-cable by the plug. Never pull out the plug by pulling the power-cable.
- Make sure that the available voltage is between 220v/240v.
- Make sure that the power-cable is never crimped or damaged. Check the equipment and the power-cable periodically.
- If the equipment is dropped or damaged, disconnect the mains power supply immediately. Have a qualified engineer inspect the equipment before operating again.
- If the equipment has been exposed to drastic temperature fluctuation (e.g. after transportation), do not switch it on immediately. The arising condensation might damage the equipment. Leave the equipment switched off until it has reached room temperature.
- If your product fails to function correctly, discontinue use immediately. Pack the unit securely (preferably in the original packing material), and return it to your Prolight dealer for service.
- Only use fuses of same type and rating.
- Repairs, servicing and power connection must only be carried out by a qualified technician. **THIS UNIT CONTAINS NO USER SERVICEABLE PARTS.**
- **WARRANTY;** One year from date of purchase.

OPERATING DETERMINATIONS

If this equipment is operated in any other way, than those described in this manual, the product may suffer damage and the warranty becomes void.

Incorrect operation may lead to danger e.g.: short-circuit, burns, electric shocks, lamp failure etc.

Do not endanger your own safety and the safety of others!
Incorrect installation or use can cause serious damage to people and property.

You should find inside the Laser carton the following items:

- 1, Gemini Laser 2, Power cable 3, User manual

Technical Specifications:

DMX channels: 4

Laser diode: 1 x 50mW Green (532nm) DPSS laser

1 x 100mW Red (650nm) DPSS laser

Micro-stepping motor with extra wide scanner angle

Operating modes: 1, Sound Active

2, Auto Run

3, DMX

Power consumption: 16W

Power supply: 240V - 50Hz

Dimensions: 233 x 210 x 171mm

Weight: 2.4Kgs

Fuse: 2A

Features:

The Gemini features 4 DMX channels and many laser patterns and gobo projections that are ideal with or without fog.

Back view:

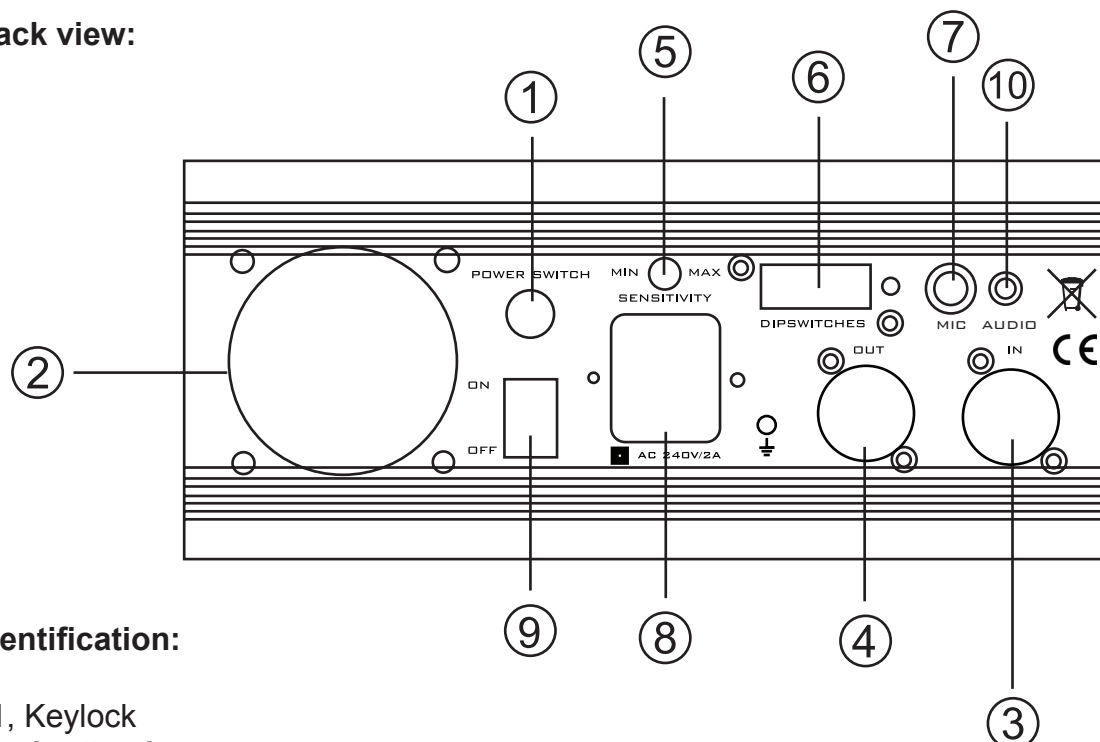

Identification:

- 1, Keylock
- 2, Cooling fan
- 3, DMX In
- 4, DMX out
- 5, Audio sensitivity knob
- 6, Dipswitches
- 7, Microphone
- 8, Power input
- 9, Power switch
- 10, Audio LED

Operation modes:

The Gemini has three modes of operation as follows:

1, Sound active mode

To select sound active mode set dipswitch 10 to the **ON** position. You can now use the sensitivity control on the back panel to set the required sound level. With no music present, the laser diode will turn **OFF** and will come back **ON** as soon as the music starts again.

2, Auto mode

To select auto mode, set dipswitches 9 and 10 to the **ON** position and all others to **OFF**. The Gemini will now cycle through all its internal geometric patterns. In this mode the laser diode will remain on constantly until the power is turned **OFF** or the mode is changed.

3, DMX mode

To select DMX mode, set all dipswitched to the **OFF** position. You can now set the required DMX address using dipswitches 1 to 9. Please refer to the chart below for DMX functions.

DMX function chart:

Channel	DMX Address	Function
CH.1	0-49	Off
	50-99	Auto mode
	100-149	Sound active
	150-209	Green gobos only
	209-255	Red firework only
CH.2	0-99	Anti-clock wise rotation
	100-199	Clock wise rotation
	200-255	Anti-clock wise to clock wise rotation
CH.3	0-255	Speed (slow to fast)
CH.4	0-69	Red firework effect on only
	70-139	Green gobos on only
	140-209	Red and Green on
	210-255	Red and green flash on/off simultaneously

DMX Control Mode

Operating in a DMX control mode environment gives the user the greatest flexibility when it comes to customising or creating a show. In this mode you will be able to control each individual trait of the fixture and each fixture independently.

Setting the DMX address

The DMX mode enables the use of a universal DMX controller. Each fixture requires a “start address” from 1- 511. A fixture requiring one or more channels for control begins to read the data on the channel indicated by the start address. For example, a fixture that occupies or uses 7 channels of DMX and was addressed to start on DMX channel 100, would read data from channels: 100,101,102,103,104,105 and 106. Choose a start address so that the channels used do not overlap. E.g. the next unit in the chain starts at 107.

Set the start address using the group of dip switches located usually on the back of the fixture. Each dipswitch has an associated value. Adding the value of each switch in the ON position will provide the start address. Determining which switches to toggle ON given a specific start address can be accomplished in the following manner. By subtracting the largest switch value possible from the selected start address until zero is achieved.

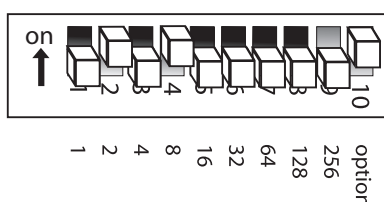
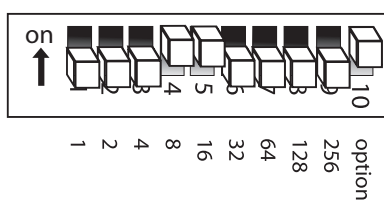
<p>EXAMPLE STARTING ADDRESS</p>																								
<p>Address 10</p> <p>Pin NO: 4 = 8 Pin NO: 2 = 2 Total = 10</p>																								
<p>Address 24</p> <p>Pin NO: 5 = 16 Pin NO: 4 = 8 Total = 24</p>																								
<p>DMX address using simple maths</p>	<p>233 - (128 = 105, Turn on dip No: 8 105 - (64) = 41, Turn on dip No:7 41 - (32) = 9, Turn on dip No: 6 9 - (8) = 1, Turn on dip No: 4 1 - (1) = 0, Turn on dip No:1</p> <p>You will most likely use the first available number which maybe Number 1. This number was selected for example purposes</p>	<table border="1"> <thead> <tr> <th>DIP SWITCH</th> <th>(DMX VALUE)</th> </tr> </thead> <tbody> <tr><td>1</td><td>1</td></tr> <tr><td>2</td><td>2</td></tr> <tr><td>3</td><td>4</td></tr> <tr><td>4</td><td>8</td></tr> <tr><td>5</td><td>16</td></tr> <tr><td>6</td><td>32</td></tr> <tr><td>7</td><td>64</td></tr> <tr><td>8</td><td>128</td></tr> <tr><td>9</td><td>256</td></tr> <tr><td>10</td><td></td></tr> </tbody> </table>	DIP SWITCH	(DMX VALUE)	1	1	2	2	3	4	4	8	5	16	6	32	7	64	8	128	9	256	10	
DIP SWITCH	(DMX VALUE)																							
1	1																							
2	2																							
3	4																							
4	8																							
5	16																							
6	32																							
7	64																							
8	128																							
9	256																							
10																								

DMX-512:

- DMX (Digital Multiplex) is a universal protocol used as a form of communication between intelligent fixtures and controllers. A DMX controller sends DMX data instructions from the controller to the fixture. DMX data is sent as serial data that travels from fixture to fixture via the DATA “IN” and DATA “OUT” XLR terminals located on all DMX fixtures (most controllers only have a data “out” terminal).

DMX Linking:

- DMX is a language allowing all makes and models of different manufactures to be linked together and operate from a single controller, as long as all fixtures and the controller are DMX compliant. To ensure proper DMX data transmission, when using several DMX fixtures try to use the shortest cable path possible. The order in which fixtures are connected in a DMX line does not influence the DMX addressing. For example; a fixture assigned to a DMX address of 1 may be placed anywhere in a DMX line, at the beginning, at the end, or anywhere in the middle. When a fixture is assigned a DMX address of 1, the DMX controller knows to send DATA assigned to address 1 to that unit, no matter where it is located in the DMX chain.

DATA Cable (DMX cable) requirements (for DMX operation):

- The Equinox Gemini laser can be controlled via DMX-512 protocol. The DMX address is set on the back of the unit. Your unit and your DMX controller require a standard 3-pin XLR connector for data input/output (figure 1).

Figure 1

Further DMX cables can be purchased from all good sound and lighting suppliers or Prolight dealers.

Please quote:

CABL10 – 2M

CABL11 – 5M

CABL12 – 10M

Also remember that DMX cable must be daisy chained and cannot be split.

Notice:

- Be sure to follow figures 2 & 3 when making your own cables. Do not connect the cable's shield conductor to the ground lug or allow the shield conductor to come in contact with the XLR's outer casing. Grounding the shield could cause a short circuit and erratic behaviour.

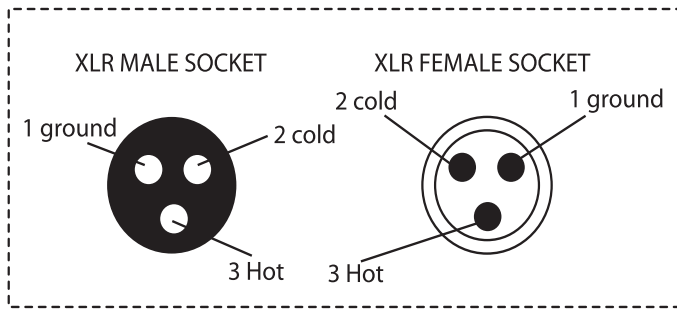
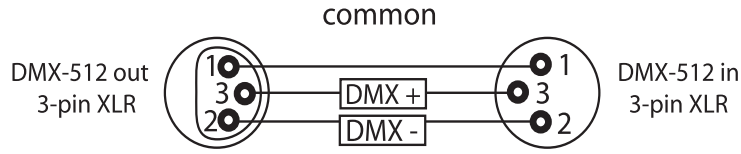

FIGURE 3

XLR Pin Configuration
Pin 1 = Ground
Pin 2 = Negative
Pin 3 = Postive

FIGURE 2

Special Note: Line termination:

- When longer runs of cable are used, you may need to use a terminator on the last unit to avoid erratic behaviour.

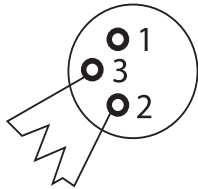

Termination reduces signal transmission problems and interference. it is always advisable to connect a DMX terminal, (resistance 120 Ohm 1/4 W) between pin 2 (DMX-) and pin 3 (DMX+) of the last fixture.

Using a cable terminator (part number CABL90) will decrease the possibilities of erratic behaviour.

5-Pin XLR DMX Connectors:

- Some manufactures use 5-pin XLR connectors for data transmission in place of 3-pin. 5-Pin XLR fixtures may be implemented in a 3-pin XLR DMX line. When inserting standard 5-pin XLR connectors in to a 3-pin line a cable adaptor must be used. The Chart below details the correct cable conversion.

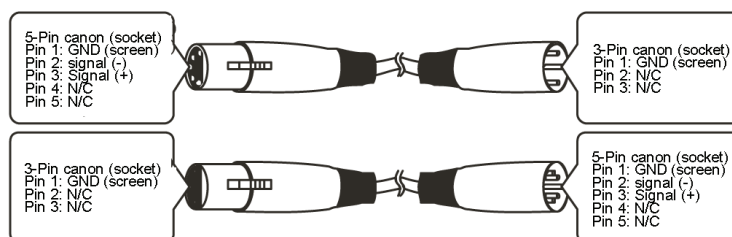

DMX Dip Switch Quick Reference Chart

Dip Switch Position

DMX DIP SWITCH SET 0=OFF 1=ON					#9	0	0	0	0	0	0	0	0	1	1	1	1	1	1	1	1		
					#8	0	0	0	0	1	1	1	1	0	0	0	0	1	1	1	1	1	1
					#7	0	0	1	1	0	0	1	1	0	0	1	1	0	0	1	1	1	1
					#6	0	1	0	1	0	1	0	1	0	1	0	1	0	1	0	1	0	1
#1	#2	#3	#4	#5																			
0	0	0	0	0		32	64	96	128	160	192	224	256	288	320	352	384	416	448	480			
1	0	0	0	0	1	33	65	97	129	161	193	225	257	289	321	353	385	417	449	481			
0	1	0	0	0	2	34	66	98	130	162	194	226	258	290	322	354	386	418	450	482			
1	1	0	0	0	3	35	67	99	131	163	195	227	259	291	323	355	387	419	451	483			
0	0	1	0	0	4	36	68	100	132	164	196	228	260	292	324	356	388	420	452	484			
1	0	1	0	0	5	37	69	101	133	165	197	229	261	293	325	357	389	421	453	485			
0	1	1	0	0	6	38	70	102	134	166	198	230	262	294	326	358	390	422	454	486			
1	1	1	0	0	7	39	71	103	135	167	199	231	263	295	327	359	391	423	455	487			
0	0	0	1	0	8	40	72	104	136	168	200	232	264	296	328	360	392	424	456	488			
1	0	0	1	0	9	41	73	105	137	169	201	233	265	297	329	361	393	425	457	489			
0	1	0	1	0	10	42	74	106	138	170	202	234	266	298	330	362	394	426	458	490			
1	1	0	1	0	11	43	75	107	139	171	203	235	267	299	331	363	395	427	459	491			
0	0	1	1	0	12	44	76	108	140	172	204	236	268	300	332	364	396	428	460	492			
1	0	1	1	0	13	45	77	109	141	173	205	237	269	301	333	365	397	429	461	493			
0	1	1	1	0	14	46	78	110	142	174	206	238	270	302	334	366	398	430	462	494			
1	1	1	1	0	15	47	79	111	143	175	207	239	271	303	335	367	399	431	463	495			
0	0	0	0	1	16	48	80	112	144	176	208	240	272	304	336	368	400	432	464	496			
1	0	0	0	1	17	49	81	113	145	177	209	241	273	305	337	369	401	433	465	497			
0	1	0	0	1	18	50	82	114	146	178	210	242	274	306	338	370	402	434	466	498			
1	1	0	0	1	19	51	83	115	147	179	211	243	275	307	339	371	403	435	467	499			
0	0	1	0	1	20	52	84	116	148	180	212	244	276	308	340	372	404	436	468	500			
1	0	1	0	1	21	53	85	117	149	181	213	245	277	309	341	373	405	437	469	501			
0	1	1	0	1	22	54	86	118	150	182	214	246	278	310	342	374	406	438	470	502			
1	1	1	0	1	23	55	87	119	151	183	215	247	279	311	343	375	407	439	471	503			
0	0	0	1	1	24	56	88	120	152	184	216	248	280	312	344	376	408	440	472	504			
1	0	0	1	1	25	57	89	121	153	185	217	249	281	313	345	377	409	441	473	505			
0	1	0	1	1	26	58	90	122	154	186	218	250	282	314	346	378	410	442	474	506			
1	1	0	1	1	27	59	91	123	155	187	219	251	283	315	347	379	411	443	475	507			
0	0	1	1	1	28	60	92	124	156	188	220	252	284	316	348	380	412	444	476	508			
1	0	1	1	1	29	61	93	125	157	189	221	253	285	317	349	381	413	445	477	509			
0	1	1	1	1	30	62	94	126	158	190	222	254	286	318	350	382	414	446	478	510			
1	1	1	1	1	31	63	95	127	159	191	223	255	287	319	351	383	415	447	479	511			

Dip Switch position

DMX Address

Class 3B Laser Safety Guide

Warning

Class 3B Lasers have the potential to harm eyesight if viewed directly and can also be harmful at long distances.

Any unit that contains a laser diode has to be classified depending upon the light output that someone may be exposed to. All laser products are classed as defined in the *Laser Product Safety Standard (BS/EN 60825.1)*. The classes range from the safest, which is *Class 1*, through to the most hazardous, which is *Class 4*. A laser diode that emits more than *5mW* of light and less than *500mW* can be classified as a *Class 3B* product.

Operation and installation Notes

Laser effects should only be installed and operated by persons who have been trained in how to operate laser effects safely.

Laser effects should be located in a safe and secure position in the venue, so that once installed it cannot be tampered with by unauthorized users.

Before operation the path of the laser beams should be taken into account in respect to how the beams will scan the viewing audience.

If direct audience scanning is to be used then the laser energy levels from the effects needs to be calculated.

Health

If used responsibly and in accordance with the relevant guidance issued by the Health and Safety Executive a laser effect will not present a hazard to those viewing the show as long as the laser beams are projected over the heads of the viewing audience. When laser effects are directed into the audience area it becomes difficult to tell if the effects are causing harm.

Class 3B laser beams can be harmful to eyesight if viewed directly. The injury that a Class 3B laser can inflict is dependant upon several varients, including the amount of time the laser beam enters the eye for, the intensity of beam and what part of the eye that actually receives the beam. The part of the eye which is most susceptible to receive damage from the beam is the retina. The retina is the part of the eye that receives the light signals that are sent to brain. All light entering the eye gets focused onto the retina.

Normal light sources including halogen lamps are not usually harmful to view. Lasers are different in the fact that they can get the beam focused down to a very small point on the retina which can burn holes on the back wall of the eye. There are no pain receptors on the retina and the damage can happen in less time than it takes for a person to blink so the person will be not be aware of any damage taking place. Damage to the retina cannot be repaired and therefore is permanent. Symptoms include severe loss of sight and unnoticeable vision loss.

Licensing and Laws

There are no U.K. “laser laws” or any “laser licenses” that need to be obtained in order to own or operate a laser for lightshow use. Detailed and specific guidance is issued by the Health and Safety Executive in the form of a book called HS(G)95 The Radiation Safety of Lasers Used for Display Purposes.

Class 3B Laser Safety Features

Class 3B laser products need to be fitted with specific safety features. These features are issued in the British Standard on Laser Product Safety

BS/EN 60825-1 and are needed for the product to meet CE approval.

The important warnings are listed below:-

- 1) Emissions Indicator
- 2) Remote Interlock Connector
- 3) Laser Safety Warning Labels

Summary of each Feature

Class 3B lasers need to contain three very important Laser Safety Warning Labels; the starburst symbol, aperture label, and the warning/classification label. The starburst is used to indicate that the product is a laser product. The aperture label is located next to the aperture to show where the laser emits its beam(s). The warning/classification label details the class of the laser product, the maximum output power, and the wavelength(s) (colours) of the laser, along with a “Laser Radiation – Avoid Exposure To The Beam” warning

The Remote Interlock Connector will only allow the laser to function when the two pins are shorted together. For lightshow use it is recommended by HS(G)95 laser safety guidance laser effects can be overridden by a remote Emergency Stop switch. The remote interlock connector provides a convenient way for such a switch to be easily added to the laser system, to provide this control.

The emissions indicator is fitted to indicate when the laser is ready to produce a light output.

Audience Scanning

Audience Scanning is when laser beams are directed at the viewing audience. Because the laser output beam can scan people’s faces it carries a risk that it could cause damage to eyesight, if over exposed to the laser beam.

Maximum Permissible Exposure (MPE)

The amount of laser light that a person can be exposed to without it causing harm to eyesight is known as the Maximum Permissible Exposure or MPE. These levels are set down by the British Laser Safety Standard BS/EN 60826-1. When people are exposed to laser light output which is above the MPE, it may potentially pose a risk of causing eye damage. Calculating what the MPE and exposure level is for a given laser effect is quite a complicated process and it is dependant on a whole number of factors and conditions. The laser safety standard BS/EN 60825-1 contains the information and data required to calculate these levels.

Laser Safety Officer

The BS/EN60825-1 Laser Safety Standard recommends that all venues that use, or businesses that work with Class 3B laser products, should appoint a Laser Safety Officer (LSO). The Laser Safety Officer should be aware of the many safety issues when using lasers, and will also be responsible for overseeing how the laser is used. In smaller businesses, the (LSO) could be the installer, operator or owner etc.

Separation Distances

Health and Safety guidance details that for supervised installations of lasers which are above the Maximum Permissible Exposure (MPE) should not be accessible to persons in the audience. Also recommended is an area where the MPE may not be exceeded and extends from 3m above to 2.5m laterally from any point in the venue where the public may have access during the lightshow. The illustrations below show the separation distances.

Separation Distance Drawing:

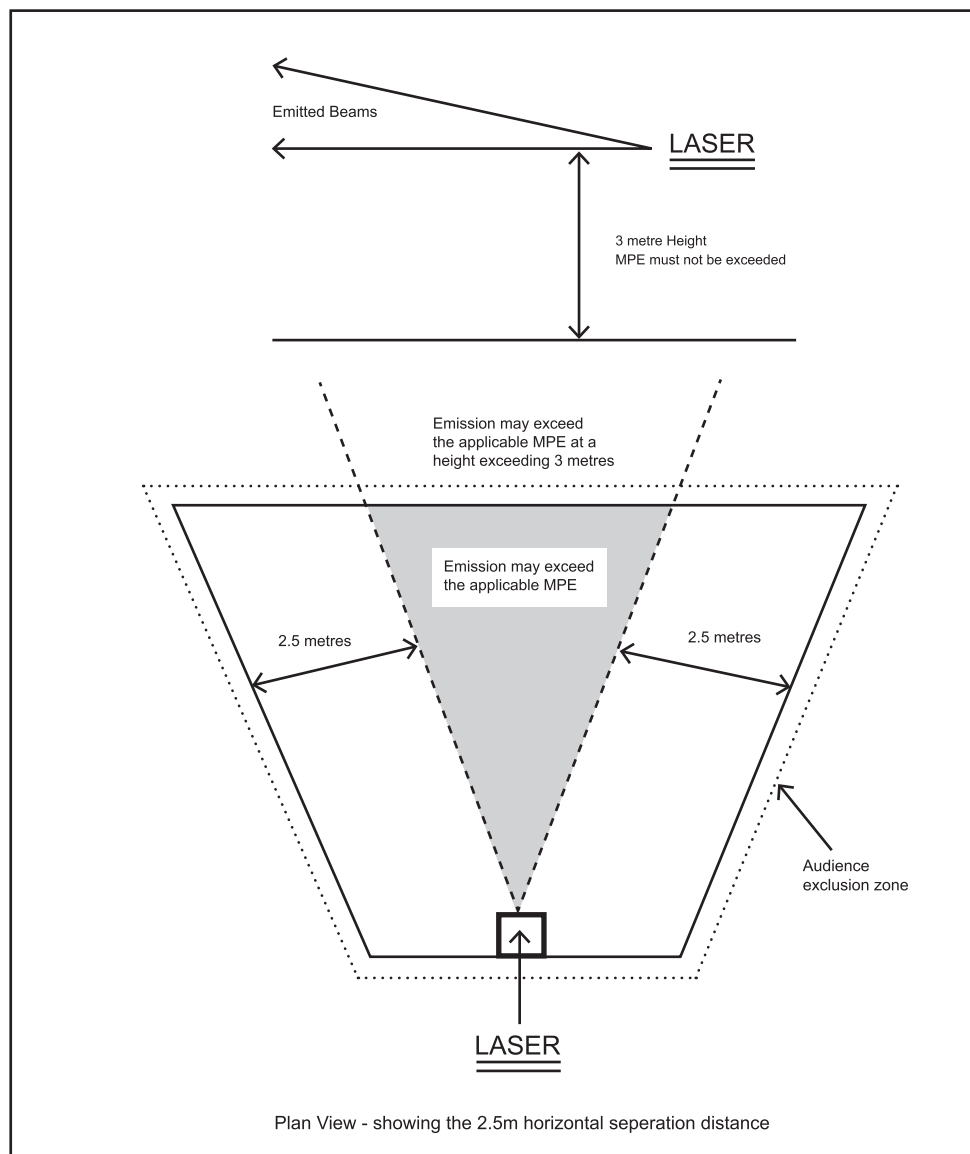

Note. The 3 metre height specified is not the height of the actual laser unit, but it refers to the height of the laser beams emitted.

Hazard Distances

All lasers for display purposes feature a characteristic called the hazard distance for direct viewing (NOHD). The (NOHD) is distance at which viewing the laser directly is no longer considered a hazard. Note at any point between the laser unit and the calculated hazard distance, it may be hazardous to directly view the laser beams. Exposing the eye to the laser directly from outside the hazard distance is considered to be no longer a risk.

The most dangerous senerio is to look directly at a static single beam, because all the light energy is concentrated into one small point. The hazard distances for various different powers of Class 3B laser are shown in the table below.

Laser Output Power	10mW	30mW	50mW	100mW	250mW	450mW
Hazard Distance	12m	20m	25m	36m	56m	76m

Note - The above values in the table have been calculated assuming the characteristics of a typical laser, which has a beam spread of 2mradians. Not all laser units have the same specification.

Remember: Static laser beams are hazardous for long distances so it is recommended that the laser beams are projected overhead and not into the viewing audience

Laser Safety Books

The Radiation Safety of Display Laser Installations HS(G)95
Published by HSE Books 1996 ISBN 0 7176 0691

Health & Safety Executive
Website - www.hse.gov.uk

Laser display safety guidance page - www.hse.gov.uk/pubns/INDG224.htm

Health Protection Agency
Website - www.hpa.org.uk