

EC - Declaration of Conformity

We declare that our products (lighting equipments) comply with the following specification and bears CE mark in accordance with the provision of the Electromagnetic Compatibility (EMC) Directive 89/336/EEC.

EN55014-2: 1997 A1: 2001, EN61000-4-2: 1995;
EN61000-4-3: 2002;
EN61000-4-4: 1995; EN61000-4-5: 1995, EN61000-4-6: 1996,
EN61000-4-11: 1994.

&

Harmonized Standard

EN60598-1: 2000+ALL: 2000+A12: 2002

Safety of household and similar electrical appliances
Part 1: General requirements

ACME®

**COLOR BAR
348TC**

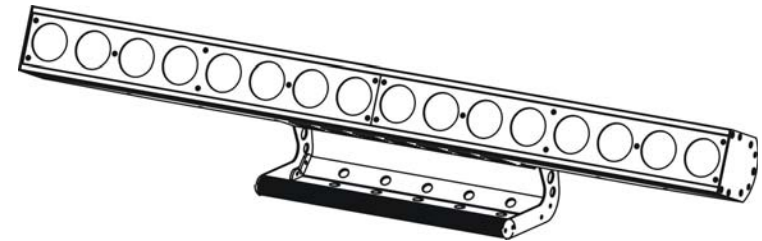

CB-348TC

User Guide

Professional Entertainment Technology

Innovation, Quality, Performance

TABLE OF CONTENTS

1. Safety Instruction
2. Technical Specification
3. How To Set The Unit
 - 3.1 Control Panel
 - 3.2 Main Function
4. How To Control The Unit
 - 4.1 Master/slave built-in preprogram function
 - 4.2 Easy controller
 - 4.3 Universal DMX controller
 - 4.4 DMX 512 Configuration
 - 4.5 DMX512 Connection
 - 4.6 RC8ch Controller
5. Troubleshooting
6. Fixture Cleaning

6. Fixture Cleaning

The cleaning of internal and external optical lenses and/or mirrors must be carried out periodically to optimize light output. Cleaning frequency depends on the environment in which the fixture operates: damp, smoky or particularly dirty surrounding can cause greater accumulation of dirt on the unit's optics.

- Clean with soft cloth using normal glass cleaning fluid.
- Always dry the parts carefully.
- Clean the external optics at least every 20 days. Clean the internal optics at least every 30/60 days.

- h. The address of lightings in the chain will be 1234-1234-...
(12345678-12345678-...)

5. Troubleshooting

Following are a few common problems that may occur during operation. Here are some suggestions for easy troubleshooting:

A. The unit does not work, no light and the fan does not work

1. Check the connection of power and main fuse.
2. Measure the mains voltage on the main connector.
3. Check the power on LED.

B. Not responding to DMX controller

1. DMX LED should be on. If not, check DMX connectors, cables to see if link properly.
2. If the DMX LED is on and no response to the channel, check the address settings and DMX polarity.
3. If you have intermittent DMX signal problems, check the pins on connectors or on PCB of the unit or the previous one.
4. Try to use another DMX controller.
5. Check if the DMX cables run near or run alongside to high voltage cables that may cause damage or interference to DMX interface circuit.

C. Some units don't respond to the easy controller

1. You may have a break in the DMX cabling.
2. Check the LED for the response of the master/ slave mode signal.

D. No response to the sound

1. Make sure the unit does not receive DMX signal.
2. Check if the sound sensitively is too low.

E. One of the channels is not working well

1. *The cable connected to the PCB may be broken.*

1. Safety Instruction



WARNING

Please read carefully the instruction, which includes important information about the installation, usage and maintenance.

- Please keep this User Guide for future consultation. If you sell the unit to another user, be sure that they also receive this instruction booklet.
- Unpack and check carefully there is no transportation damage before using the unit.
- Before operating, ensure that the voltage and frequency of power supply match the power requirements of the unit.
- It's important to ground the yellow/green conductor to earth in order to avoid electric shock.
- The unit is for indoor use only. Use only in a dry location.
- The unit must be installed in a location with adequate ventilation, at least 50cm from adjacent surfaces. Be sure that no ventilation slots are blocked.
- Disconnect main power before replacement or servicing.
- Make sure there is no flammable materials close to the unit while operating as it is fire hazard.
- Use safety cable when fixes this unit.
- Maximum ambient temperature is TA: 40°C. Don't operate it where the temperature is higher than this.
- In the event of serious operating problem, stop using the unit immediately. Never try to repair the unit by yourself. Repairs carried out by unskilled people can lead to damage or malfunction. Please contact the nearest authorized technical assistance center. Always use the same type spare parts.
- Do not touch any wire during operation as high voltage might be causing electric shock.

Warning

For power supply, do not connect in series much more than 6 units, use another mains supply for next 6 units.

- To prevent or reduce the risk of electrical shock or fire, do not expose the unit to rain or moisture.

- Do not open the unit within five minutes after switching off.
- The housing, the lenses must be replaced if they are visibly damaged.

Caution

There are no user serviceable parts inside the unit. Do not open the housing or attempt any repairs yourself. In the unlikely event your unit may require service, please contact your nearest dealer.

Installation

The unit should be mounted via its metal hole on the bracket. Always ensure that the unit is firmly fixed to avoid vibration and slipping while operating. Always ensure that the structure to which you are attaching the unit is secure and is able to support a 10 times weight of the unit.

2. Technical Specification

- 3/6/6/9/12/15 channels switchable
- Automatically switching between music trig and auto mode
- Great built-in programs under Master/Slave mode triggered by music
- Individual control of each LED cluster
- Sound sensitivity adjustable via the menu
- Auto-fading show with 3 different speeds
- Specially designed stand for floor operation
- LCD display for easy addressing and setting
- **Power Supply:** 100~240V 50/60Hz
- **Fuse:** T 6.3A
- **Power consumption:** 152W
- **LED:** 3W Tri-color x 48pcs (Red:16pcs, Green: 16pcs, Blue:16pcs)
- **Dimension:** 965 x 167 x 152 mm
- **Weight:** 7.2kgs

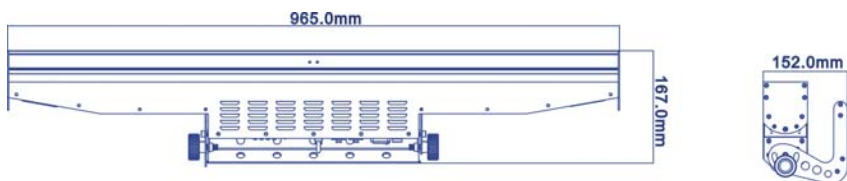

4.6 RC8ch Controller

Address setting

Each time you make a different connection, you have to reset the address. There are two ways that you can set address for the LED lightings:

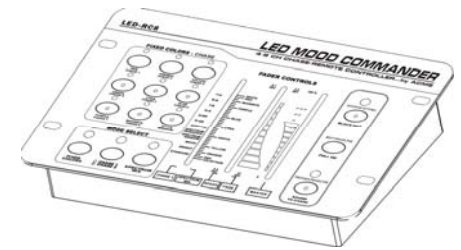

Manual address setting:

- Set LED-RC8 to 4 Ch. (the address should be 1,2, 3 or 4) or 8 Ch. (the address should be 1,2,3,4, 5, 6, 7, or 8) mode.
- Connecting all LED lightings to the LED-RC8 and power them on.
- Hold the "black out" button for about 5 seconds until the red indicator LED blinking.
- The first LED lighting will be on.
- Set address for the first lighting by pressing the chase 1-8 buttons.
- Press the "sound to chase" or "full on" button to select other fixtures, and addressing for them.
- Press the "black out" button for about 5 seconds to exit address setting.

Button	address
Chase 1	1
Chase 2	2
Chase 3	3
Chase 4	4
Chase 5	5
Chase 6	6
Chase 7	7
Chase 8	8

Automatic address setting:

- Set LED-RC8 to 4 Ch. (the address should be 1, 2, 3 or 4) or 8 Ch. (the address should be 1, 2, 3, 4, 5, 6, 7, or 8) mode.
- Connecting all LED lightings to the LED-RC8 and power them on.
- Hold the "black out" button for about 5 seconds until the red indicator LED blinking.
- The first LED lighting will be on.
- Press the "sound to chase" or "full on" button until all LED lightings on.
- Press "random" button to set address automatically.
- Press the "black out" button for about 5 seconds to exit address setting.

4.5 DMX512 Connection

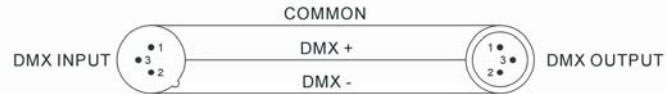
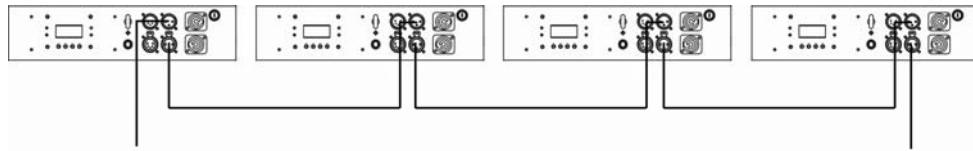

Termination reduces signal errors and to avoid signal transmission problems and interference. It is always advisable to connect a DMX terminal. (Resistance 120 ohm 1/4W) between pin 2 (DMX-) and pin 3 (DMX+) of the last fixture.

1. If you using a controller with 5 pins DMX output, you need to use a 5 to 3 pin adapter-cable.
2. At last unit, the DMX cable has to be terminated with a terminator. Solder a 120 ohm 1/4W resistor between pin 2 (DMX-) and pin 3 (DMX+) into a 3-pin XLR-plug and plug it in the DMX-output of the last unit.
3. Connect the unit together in a `daisy chain` by XLR plug from the output of the unit to the input of the next unit. The cable can not branched or split to a `Y` cable. DMX 512 is a very high-speed signal. Inadequate or damaged cables, soldered joints or corroded connectors can easily distort the signal and shut down the system.
4. The DMX output and input connectors are pass-through to maintain the DMX circuit, when power is disconnected to the unit.
5. Each lighting unit needs to have an address set to receive the data sent by the controller. The address number is between 0-511 (usually 0 & 1 are equal to 1).
6. The end of the DMX 512 system should be terminated to reduce signal errors.
7. 3 pin XLR connectors are more popular than 5 pin XLR.
 - 3 pin XLR: Pin 1: GND, Pin 2: Negative signal (-), Pin 3: Positive signal (+)
 - 5 pin XLR: Pin 1: GND, Pin 2: Negative signal (-), Pin 3: Positive signal (+)
 - Pin 4/5: Not used.

3. How To Set The Unit

3.1 Control Panel

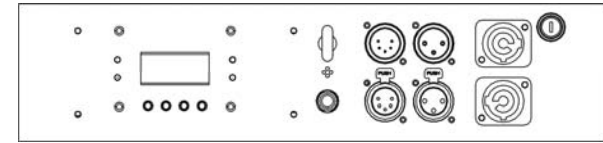

Display

To show the various menus and the selected functions

LED

DMX	On	DMX input present
MASTER	On	Master Mode
SLAVE	On	Slave Mode
SOUND	Flashing	Sound activation

Button

MENU	To select the programming functions
DOWN	To go backward in the selected functions
UP	To go forward in the selected functions
ENTER	To confirm the selected functions

Microphone

Receive the sound to control the unit

Only for remote control

By connect to the 1/4" microphone jack to control the unit for Stand by, Function and Mode function.

Mains input

Connect to supply mains power.

Mains output

Connect to supply mains power for other units.

Fuse

For over current protection.

DMX input/output

For DMX512 link, use 3/5-pin XLR plug cable to link the unit together.

Safety Ring

Keep the installation safe.

3.2 Main Function

To select any of the given functions, press the **MENU** button up to when the required one is showing on the display. Select the function by **ENTER** button and the display will blink. Use **DOWN** and **UP** button to change the mode. Once the required mode has been selected, Press **ENTER** button to store. Back to the main functions without any change press the **MENU** button or wait for 8 seconds.

Hold **MENU** button to quit menu mode, the unit will run the built-in program you selected. At this time you can press **DOWN** and **UP** button to change show, the new show will effect immediately. If you change to show 1-8 or Auto Fade, you can press **ENTER** button to choose speed. The unit will run in the speed that selected or it will run to the music.

The main functions are shown below:

15 Channel mode							
CH 1	CH2	CH3	CH 4	CH5	CH6	CH 7	CH8
Red (G1)	Green (G1)	Blue (G1)	Red (G2)	Green (G2)	Blue (G2)	Red (G3)	Green (G3)
CH9	CH10	CH11	CH12	CH13	CH14	CH15	
Blue (G3)	Red (G4)	Green (G4)	Blue (G4)	Color	Dimmer	Strobe	
				248-255 Color 32 240-247 Color 31 232-239 Color 30 225-231 Color 29 217-224 Color 28 209-216 Color 27 202-208 Color 26 194-201 Color 25 186-193 Color 24 178-185 Color 23 171-177 Color 22 163-170 Color 21 155-162 Color 20 148-154 Color 19 140-147 Color 18 132-139 Color 17 124-131 Color 16 117-123 Color 15 109-116 Color 14 101-108 Color 13 093-100 Color 12 086-092 Color 11 078-085 Color 10 070-077 Color 9 063-069 Color 8 055-062 Color 7 047-054 Color 6 039-046 Color 5 032-038 Color 4 024-031 Color 3 016-023 Color 2 008-015 Color 1 000-007 Off		248-255 Open 240-247 Random Strobe 232-239 Open 190-231 Slow close fast open 182-189 Open 140-181 Slow open fast close 132-139 Open 16-131 ⚡⚡⚡ 8-16 ⚡ 0-7 Open Blackout	

12 Channel mode											
CH 1	CH2	CH3	CH 4	CH5	CH6	CH 7	CH8	CH9	CH 10	CH11	CH12
Red (G1)	Green (G1)	Blue (G1)	Red (G2)	Green (G2)	Blue (G2)	Red (G3)	Green (G3)	Blue (G3)	Red (G4)	Green (G4)	Blue (G4)
255 100%	255 100%	255 100%	255 100%	255 100%	255 100%	255 100%	255 100%	255 100%	255 100%	255 100%	255 100%
0 0%	0 0%	0 0%	0 0%	0 0%	0 0%	0 0%	0 0%	0 0%	0 0%	0 0%	0 0%

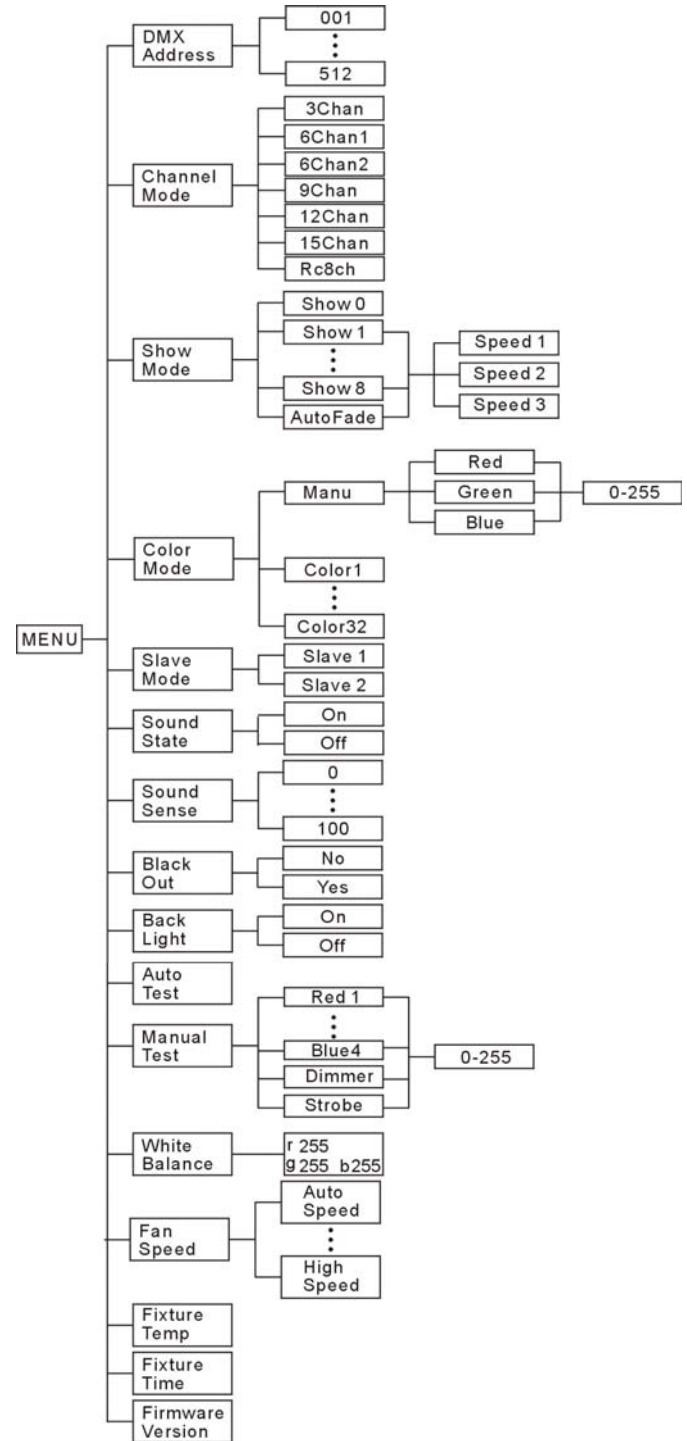

DMX Address

Press the **MENU** button up to when the **DMX Address** is showing on the display. Press **ENTER** button and the display will blink. Use **DOWN** and **UP** button to change the DMX512 address. Once the address has been selected, press the **ENTER** button to store. Back to the main functions without any change press the **MENU** button (or wait for 8 seconds to exit menu mode).

Channel Mode

Press the **MENU** button up to when the **Channel Mode** is showing on the display. Press **ENTER** button and the display will blink. Use **DOWN** and **UP** button to select the **3**, **6**, **9**, **12**, **15** or **Rc8ch** channels mode. Once selected, press the **ENTER** button to store. Back to the main functions without any change press the **MENU** button or wait for 8 seconds.

Show Mode

Press the **MENU** button up to when the **Show Mode** is showing on the display. Press **ENTER** button, the display will blink. Press **DOWN** and **UP** button to select **Show 0** (Auto show), **Show 1** or ... or **Show 8** or **Auto Fade**, once selected, press **MENU** button to store and back to the last menu, then the unit will run to music. If you choose **Show 1-8** or **Auto Fade**, press the **ENTER** button to confirm, then you can press **DOWN** and **UP** button to select **Speed 1** (slow speed) or **Speed 2** (middle speed) or **Speed 3** (fast speed), press **ENTER** button to store, the unit will run in the speed that selected. Back to the main functions without any change press the **MENU** button or wait for 8 seconds.

Color Mode

Press the **MENU** button up to when the **Color Mode** is showing on the display. Press **ENTER** button, the display will blink. Press **DOWN** and **UP** button to select **Manu** (manual setting), **Color 1** or ... or **Color 32**, once selected, press **MENU** button to store. If you choose **Manu**, press the **ENTER** button to confirm, you can press **DOWN** and **UP** button to select **Red** or **Green** or **Blue**, press **ENTER** button to confirm and press **DOWN** and **UP** button to adjust the value, then press **ENTER** button to store. Back to the main functions without any change press the **MENU** button or wait for 8 seconds.

Slave Mode

Press the **MENU** button up to when the **Slave Mode** is showing on the display. Press **ENTER** button and the display will blink. Use **DOWN** and **UP** button to select the **slave 1** or **slave 2** mode. Once selected, press the **ENTER** button to store. Back to the main functions without any change press the **MENU** button (or wait for 8 seconds to exit menu mode).

Sound State

Press the **MENU** button up to when the **Sound State** is showing on the display. Press

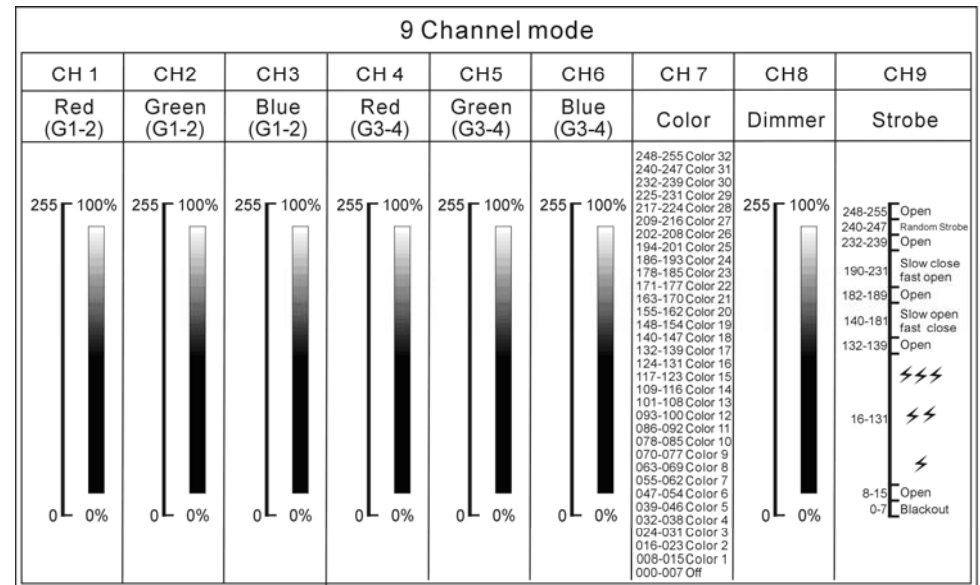
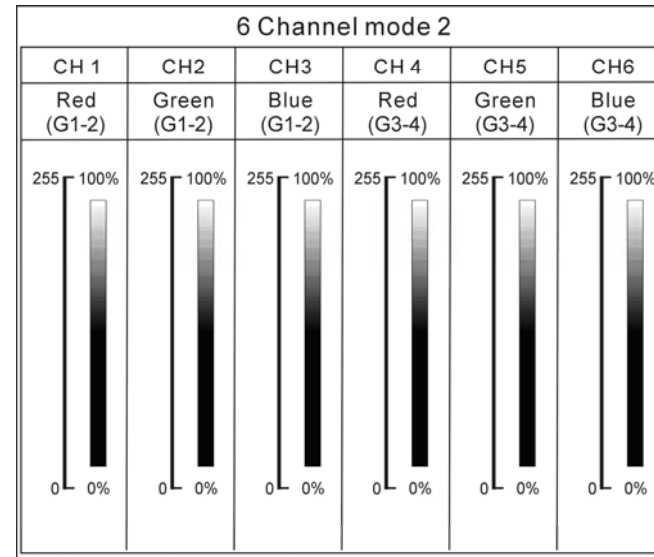

4.4 DMX 512 Configuration

Front View:

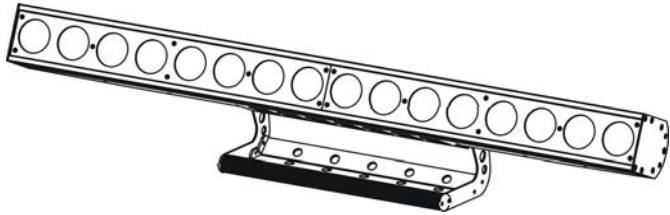

DMX Configuration:

3 Channel mode			6 Channel mode 1					
CH 1	CH2	CH3	CH 1	CH2	CH3	CH 4	CH5	CH6
Red	Green	Blue	Red	Green	Blue	Color	Dimmer	Strobe
255 100% 0% 0%	255 100% 0% 0%	255 100% 0% 0%	255 100% 0% 0%	255 100% 0% 0%	255 100% 0% 0%	248-255 Color 32 240-247 Color 31 232-239 Color 30 225-231 Color 29 217-224 Color 28 209-216 Color 27 202-208 Color 26 194-201 Color 25 186-193 Color 24 178-185 Color 23 171-177 Color 22 163-170 Color 21 155-162 Color 20 148-154 Color 19 140-147 Color 18 132-139 Color 17 124-131 Color 16 117-123 Color 15 109-116 Color 14 101-108 Color 13 093-100 Color 12 086-092 Color 11 078-085 Color 10 070-077 Color 9 063-069 Color 8 055-062 Color 7 047-054 Color 6 039-046 Color 5 032-038 Color 4 024-031 Color 3 016-023 Color 2 008-015 Color 1 000-007 Off	255 100% 0% 0%	248-255 Open 240-247 Random Strobe 232-239 Open 190-231 Slow close 182-189 fast open 140-181 Slow open 132-139 fast close 16-131 Open 8-15 Open 0-7 Blackout

ENTER button and the display will blink. Use **DOWN** and **UP** button to select the **on** (sound control on) or **off** (sound control off) mode. Once selected, press the **ENTER** button to store. Back to the main functions without any change press the **MENU** button (or wait for 8 seconds to exit menu mode).

Sound Sense

Press the **MENU** button up to when the **Sound Sense** is showing on the display. Press **ENTER** button and the display will blink. Use **DOWN** and **UP** button to adjust the sound sensitively (1-100) of the unit. Once the value has been selected, press the **ENTER** button to store. Back to the main functions without any change press the **MENU** button (or wait for 8 seconds to exit menu mode).

Black Out

Press the **MENU** button up to when the **Black Out** is showing on the display. Pressing **ENTER** button and the display will blink. Use **DOWN** and **UP** button to select the **yes** (yes blackout) or **no** (no blackout) mode. Once selected, press the **ENTER** button to store. Back to the main functions without any change press the **MENU** button (or wait for 8 seconds to exit menu mode).

Back Light

Press the **MENU** button up to when the **Back Light** is showing on the display. Pressing **ENTER** button and the display will blink. Use **DOWN** and **UP** button to select the **on** (back light on) or **off** (back light off 1 minute after auto show) mode. Once selected, press the **ENTER** button to store. Back to the main functions without any change press the **MENU** button (or wait for 8 seconds to exit menu mode).

Auto Test

Press the **MENU** button up to when the **Auto Test** is showing on the display. Pressing **ENTER** button and the display will show **Test...** and the unit will run self-test by built-in program. To go back to the functions press the **MENU** button.

Manual Test

Press the **MENU** button up to when the **Manual Test** is showing on the display. Press **ENTER** button and **Red 1** will blink, use **UP and DOWN** button to choose **Green 1** or **Blue 1** or **Red2** or ... or **Blue4** or **Dimmer** or **Strobe**, press **ENTER** button to enter, then press **UP and Down** button to adjust the value and press **ENTER** button to choose next optional. Back to the main functions without any change please press the **MENU** button.

White Balance

Press the **MENU** button up to when the **White Balance** is showing on the display. Press **ENTER** button and the **r 255** will blink, press **UP and Down** button to adjust the value, press

ENTER button to store and **g 255** will blink on the display, press **UP** and **Down** button to adjust the value, press **ENTER** button to store and **b 255** will blink on the display, press **UP** and **Down** button to adjust the value, and press **ENTER** button to store. Back to the main functions without any change please press the **MENU** button.

Fan Speed

Press the **MENU** button up to when the **Fan Speed** is showing on the display. Pressing **ENTER** button and the display will blink. Use **DOWN** and **UP** button to select **Auto Speed** (When the temperature of the unit under 40°C, FAN stops; between 45°C~55°C, FAN runs at half speed; above 60°C, FAN runs at full speed. The LEDs will be off if the temperature higher than 75°C) or **High Speed**, press **ENTER** button to store. To go back to the functions press the **MENU** button.

Fixture Temp

Press the **MENU** button up to when the **Fixture Temp** is blinking on the display. Pressing **ENTER** button and the display will show the temperature of the unit. To go back to the functions press the **MENU** button.

Fixture Time

Press the **MENU** button up to when the **Fixture Time** is blinking on the display. Pressing **ENTER** button and the display will show the number of working hours of the unit. To go back to the functions press the **MENU** button.

Firmware Version

Press the **MENU** button up to when the **Firmware Version** is blinking on the display. Pressing **ENTER** button and the display will show the version of software of the unit. To go back to the functions press the **MENU** button.

4. How To Control The Unit

You can operate the unit in three ways:

1. By master/slave built-in preprogram function
2. By easy controller
3. By universal DMX controller
4. By Rc8ch controller

4.1 Master/Slave Built In Preprogrammed Function

By linking the units in master/slave connection, the first unit will control the other units to give an automatic, sound activated, synchronized light show. This function is good when you want an instant show.

2-light show

In slave mode, slave 1 means the unit run as the master unit and slave 2 means 2-light show. In order to create a great light show, you can set slave 2 on the second unit to get contrast movement to each other, even if you have two units only.

4.2 Easy Controller

The easy remote control is used only in master/slave mode. By connecting to the 1/4" microphone jack of the first unit, you will find that the remote controller on the first unit will control all the other units for Stand by, Function and Mode selection.

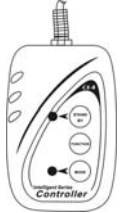

Stand By	Blackout the unit			
Function	1. Sync. Strobe 2. Async strobe 3. Sound Strobe	Select Manua Color or color 1-32	Select show 1-8 or Auto fade	Select Speed 1. Fast 2. Middle 3. Slow
Mode	Sound (LED OFF)	LED On	Slow blinking	Fast blinking

4.3 DMX Controller

Using universal DMX controller to control the units, you have to set DMX address from 1 to 512 channel so that the units can receive DMX signal.

Press the **MENU** button up to when the **DMX Address** is showing on the display. Press **ENTER** button and the display will blink. Use **DOWN** and **UP** button to change the DMX512 address. Once the address has been selected, press and keep **ENTER** button to store. To go back to the functions without any change press the **MENU** button or wait for 8 seconds to exit menu mode.

Please refer to the following diagram to address your DMX512 channel for the first 4 units:

Channel Mode	Unit 1	Unit 2	Unit 3	Unit 4
3 channels	1	4	8	12
6 channels1	1	7	13	19
6 channels2	1	7	13	19
9 channels	1	10	19	28
12 channels	1	13	25	37
15channels	1	16	31	46