

Technical Specifications

IM-8S

Power	AC 120V~60Hz or AC 230/240/250V 50/60Hz
Fuse	20mm Glass T10A Fast Blow
Lamp	MSD 250/2
Dimension	360mm x 397mm x 503mm
Weight	26 kg

IM-7S

Power	AC 120V~60Hz or AC 230/240/250V 50/60Hz
Fuse	20mm Glass T6.3A Fast Blow
Lamp	HTI 150W
Dimension	373mm x 295mm x 451 mm
Weight	13 kg

Innovation , Quality , Performance

iSolution
Your integrated Solution

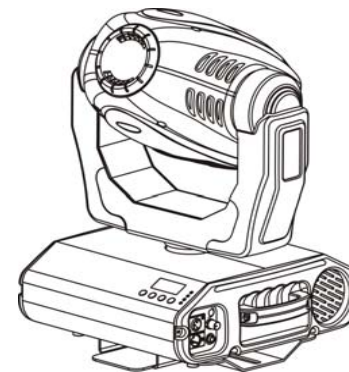

IM-8S

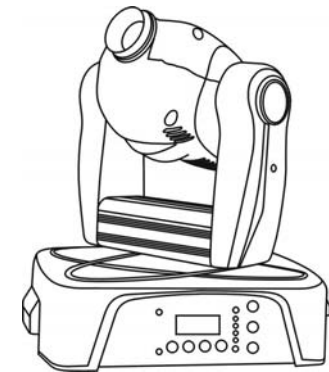

IM-7S

User Guide

Professional Entertainment Technology

7. Fixture Cleaning

The cleaning of internal and external optical lenses and/or mirrors must be carried out periodically to optimize light output. Cleaning frequency depends on the environment in which the fixture operates: damp, smoky or particularly dirty surrounding can cause greater accumulation of dirt on the unit's optics.

Clean with soft cloth using normal glass cleaning fluid.

Always dry the parts carefully.

Clean the external optics at least every 20 days. Clean the internal optics at least every 30/60 days.

EC Declaration of Conformity

We declare that our products (lighting equipments) comply with the following specification and bears CE mark in accordance with the provision of the Electromagnetic Compatibility (EMC) Directive 89/336/EEC.

EN55014-2: 1997 A1:2001, EN61000-4-2: 1995; EN61000-4-3:2002;
EN61000-4-4: 1995; EN61000-4-5: 1995, EN61000-4-6:1996,
EN61000-4-11: 1994.

&

Harmonized Standard

EN60598-1: 2000+ALL:2000+A12:2002
Safety of household and similar electrical appliances
Part 1 : General requirements

2E

TABLE OF CONTENTS

1. Safety Instruction
2. Technical Specification
 - 2.1 Inserting/Exchanging rotating gobos
 - 2.2 Beam angel
3. Lamp
4. How To Set The Unit
 - 4.1 Control Panel
 - 4.2 Main Function
5. How To Control The Unit
 - 5.1 Master/Slave Built-In Preprogrammed Function.
 - 5.2 Easy Controller
 - 5.3 iSolution Operation / Universal DMX Controller
 - 5.4 DMX512 Configuration
 - 5.5 DMX512 Connection
6. Troubleshooting
7. Fixture Cleaning

1. Safety Instruction



WARNING

Please read carefully the instruction, which includes important information about the installation, usage and maintenance.

- ◆ Please keep this User Guide for future consultation. If you sell the unit to another user, be sure that they also receive this instruction booklet.
- ◆ Unpack and check carefully there is no transportation damage before using the unit.
- ◆ Before operating, ensure that the voltage and frequency of power supply match the power requirements of the unit.
- ◆ The unit is designed for use with the MSD 250/2 (IM-8S) or HTI 150 (IM-7S). Do not use any other type of lamp.
- ◆ It's important to ground the yellow/green conductor to earth in order to avoid electric shock.
- ◆ The unit is for indoor use only. Use only in a dry location.
- ◆ The unit must be installed in a location with adequate ventilation, at least 50cm from adjacent surfaces. Be sure that no ventilation slots are blocked.
- ◆ Disconnect main power before fuse/lamp replacement or servicing.
- ◆ Replace fuse/lamp only with the same type.
- ◆ Make sure there are no flammable materials close to the unit while operating, as it is fire hazard.
- ◆ Use safety cable when fixes this unit. Don't handle the unit by taking its head only, but always by taking its base.
- ◆ Maximum ambient temperature is $T_a : 40^{\circ}\text{C}$. Don't operate it where the temperature is higher than this.
- ◆ Unit surface temperature may reach up to 85°C . Don't touch the housing bare-hand during its operation. Turn off the power and allow about 15 minutes for the unit to cool down before replacing bulb or servicing.
- ◆ In the event of serious operating problem, stop using the unit immediately. Never try to repair the unit by yourself. Repairs carried out by unskilled people can lead to damage or malfunction. Please contact the nearest authorized technical assistance center. Always use the same type spare parts.
- ◆ Don't connect the device to any dimmer pack or power pack.
- ◆ Do not touch any wire during operation as high voltage might be causing electric shock.

H. If The IM-7S pan belt is broken

1. Turn off the main power.
2. Unscrew all the screws (A) and open the base-housing cover (B).
3. Unplug all the connect wires (C) that from the arm to PC board and igniter.
4. Unscrew the screws (D) that fix the bridge (E).
5. Unscrew the screws (F) that fix the axis gear (G).
6. Change a new belt (H) by going through all connecting wires that from the arm to base, and through the bridge for correct position.
7. Set up the gear axis to the bridge and screwed it. Note: do not press the belt.
8. Put the belt around the axis gear and motor gear.
9. Plug all the connect wires (C) that form the arm to PC board and igniter.
10. Adjust the pan home position.
11. Screw the base-housing cover (B).

3E

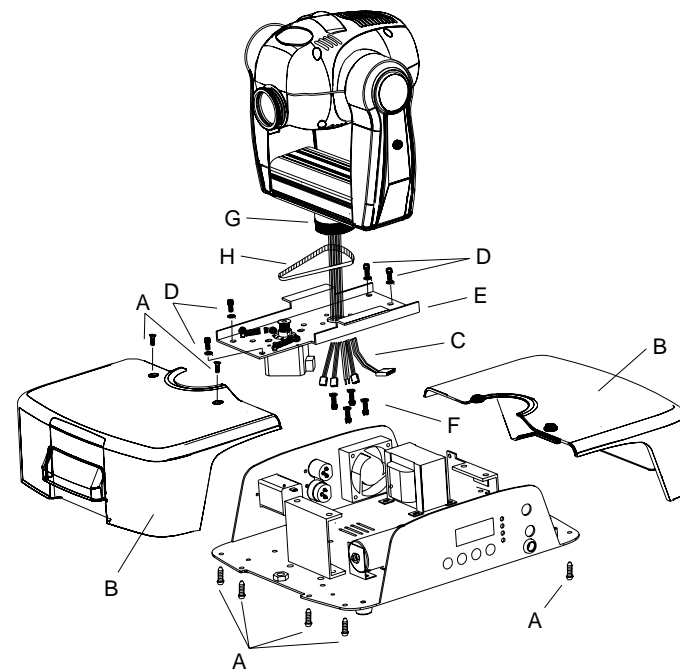

Pay attention to the belt tension when install the belt.

Please refer to the photos below: (For IM-8S)

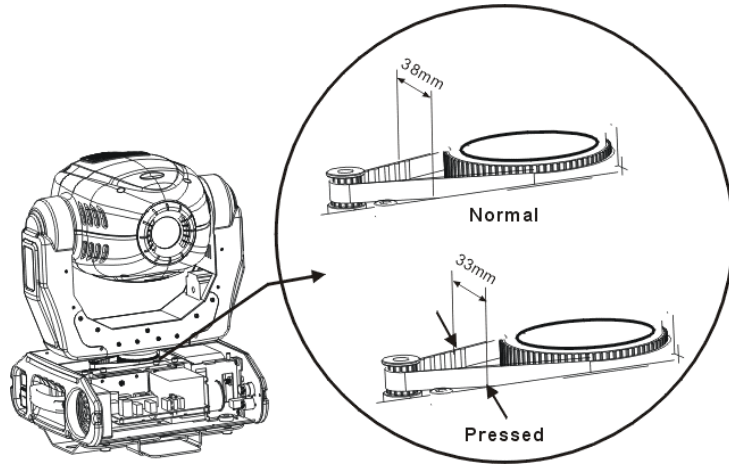

Photo 1

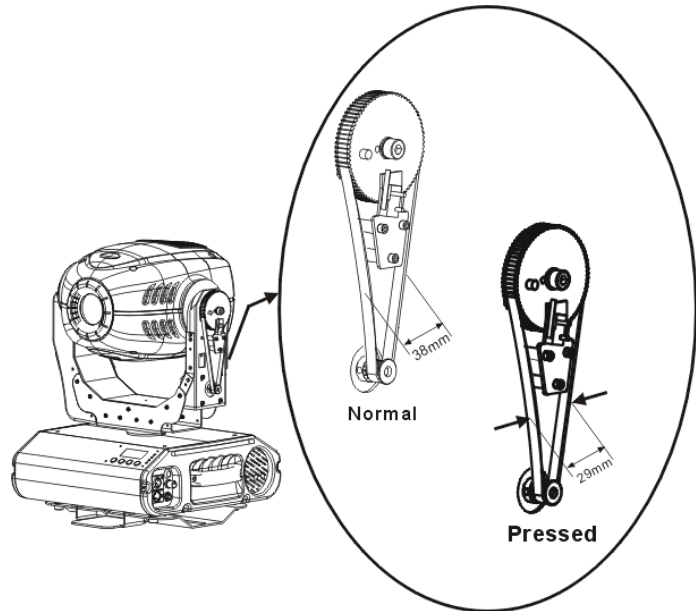

Photo 2

Warning

- ◆ To prevent or reduce the risk of electrical shock or fire, do not expose the unit to rain or moisture.
- ◆ Never touch bulb with bare fingers as it is very hot after using.
- ◆ Hot lamp explosion hazard. Do not open the unit within five minutes after switching off.
- ◆ Do not start on the unit without bulb enclosure or housing are damaged.
- ◆ The housing, the lenses, or the ultraviolet filter must be replaced if they are visibly damaged.
- ◆ Do not look directly at the light while the bulb is on.

Caution

There are no user serviceable parts inside the unit. Do not open the housing or attempt any repairs yourself. In the unlikely event your unit may require service, please contact your nearest dealer.

4E Installation

The unit should be mounted via its screw holes on the bracket. Always ensure that the unit is firmly fixed to avoid vibration and slipping while operating. Always ensure that the structure to which you are attaching the unit is secure and is able to support a weight of 30 kgs for each unit (Below drawing is for IM-8S only).

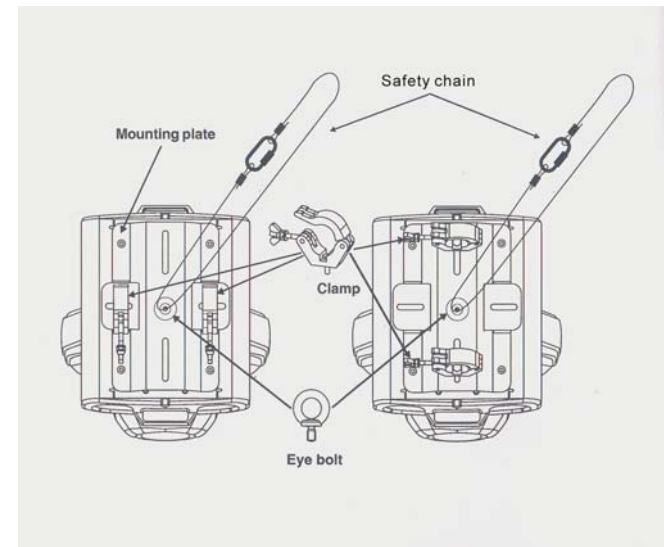

2. Technical Specification

Power supply

- AC 120V~60Hz or 230V/240V/250V 50/60Hz

Lamp

- Discharge lamp MSD 250/2 GY 9.5 (IM-8S)

- Discharge HTI 150W GY 9.5 (IM-7S)

Optical system

- Standard 13° focused beam angle.

- IM-8S : Focus adjustable by DMX control.

Shutter/Dimmer

- Blackout, 0~100 smooth dimming and strobe speed variable(1~10 flashes per second).

Gobo wheel

- Independent gobo wheel with 7 gobos plus open, gobos are interchangeable: 4 metal gobos, 2 glass gobos, and 1 effect gobo.

- Gobo wheel rotates with variable speed, giving shaking effect.

Color wheel

- Independent color wheel with 9 dichroic mirrors plus white.

- Color wheel rotates with variable speed, giving rainbow effect.

Movement

- Pan: 540° in 2.8 second.

- Tilt: 270° in 1.6 second.

DMX Channels

- Standard DMX512 signal addressing and can be controlled by any universal DMX controller.

	IM-8S	IM-7S
Channel 1	Pan motion	Pan motion
Channel 2	Tilt motion	Tilt motion
Channel 3	Shutter/ Shaking	Shutter/ Shaking
Channel 4	Gobo	Gobo
Channel 5	Color	Color
Channel 6	Gobo Rotation	Gobo Rotation
Channel 7	Dimmer	Dimmer
Channel 8	Focus	

Dimension: 360mm x 397mm x 503mm (IM-8S)

373mm x 295mm x 451mm (IM-7S)

Weight: 26 kg (IM-8S)

13 kg (IM-7S)

G. If The IM-8S pan belt is broken

1. Turn off the main power.
2. Unscrew all the screws (A) and open the base-housing cover (B).
3. Unplug all the connect wires (C) that from the arm to PC board and igniter.
4. Unscrew the screws (D) that fix the bridge (E).
5. Unscrew the screws (F) that fix the axis gear (G).
6. Change a new belt (H) by going through all connecting wires that from the arm to base, and through the bridge for correct position.
7. Set up the gear axis to the bridge and screwed it. Note: do not press the belt.
8. Put the belt around the axis gear and motor gear.
9. Plug all the connect wires (C) that form the arm to PC board and igniter.
10. Adjust the pan home position.
11. Screw the base-housing cover (B).

5E

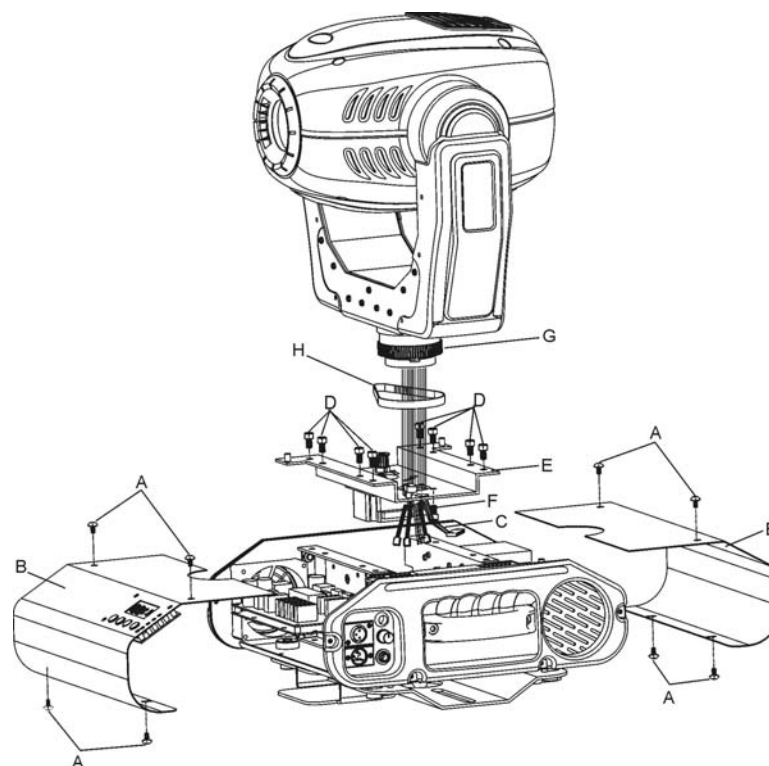

6. Troubleshooting

Following are a few common problems that may occur during operation. Here are some suggestions for easy troubleshooting:

A. The unit does not work, no light and the fan does not work

1. Check the connection of power and main fuse.
2. Measure the mains voltage on the main connector.
3. Check the power on LED.

B. Not responding to DMX controller

1. DMX LED should be on. If not, check DMX connectors, cables to see if link properly.
2. If the DMX LED is on and no response to the channel, check the address settings and DMX polarity.
3. If you have intermittent DMX signal problems, check the pins on connectors or on PCB of the unit or the previous one.
4. Try to use another DMX controller.
5. Check if the DMX cables run near or run alongside to high voltage cables that may cause damage or interference to DMX interface circuit.

C. Some units don't respond to the easy controller

1. You may have a break in the DMX cabling. Check the LED for the response of the master/ slave mode signal.
2. Wrong DMX address in the unit. Set the proper address.

D. No response to the sound

1. Make sure the unit does not receive DMX signal.
2. Check microphone to see if it is good by tapping the microphone

E. One of the channels is not working well

1. The stepper motor might be damaged or the cable connected to the PCB is broken.
2. The motor's drive IC on the PCB might be out of condition.

F. The lamp is cutting out intermittently

1. The lamp is not working well. Check the main voltage either too high or too low.
2. Internal temperature may be too high. Check and if necessary replace the fan on the head.

2.1 Inserting/Exchanging rotating gobos

DANGER!
*Install the gobos with the device switched off only.
Unplug from mains before changing gobos!*

Open the cover by loosening the fastening screw at the sides of the cover.

If you wish to use other forms and patterns as the standard-gobos, or if the gobos are to be exchanged, remove the fixation ring with an appropriate tool. Remove the gobo and insert the new gobo. Press the fixation-ring together and insert it in the front of the gobo.

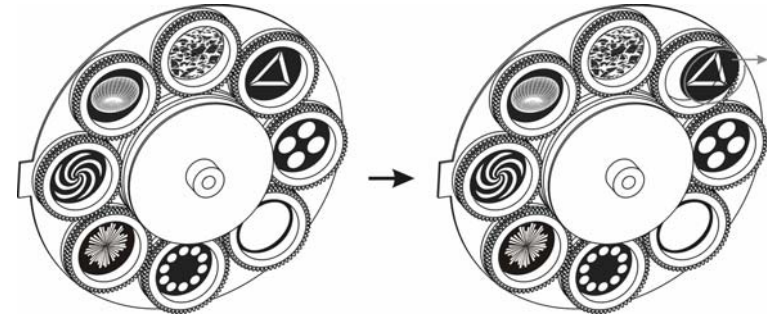

6E

CAUTION!
Never unscrew the screws of the rotating gobo as the ball bearing will otherwise be opened!

2.2 Beam angle

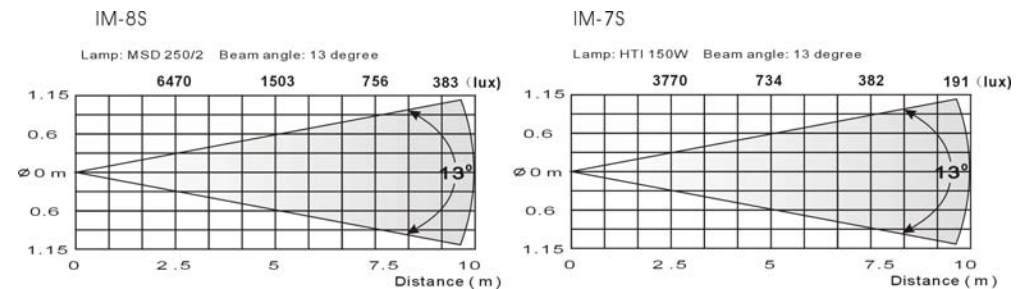

3. Lamp



In case of replacement of the lamp or maintenance, do not open the fixture within 15 minutes until the unit cools down after switching off.

Because of its high internal pressure, there might be a risk that the Discharge lamp would explode during operation. The lamp emits intense UV radiation which is harmful to the eyes and skin. The high luminance of the arc can cause severe damage to the retina if looks directly at the lamp.

Discharge lamp : MSD 250/2 (IM-8S)

HTI 150W (IM-7S)

1. Always switch off the main supply and never handle the lamp or luminaries when is hot.
2. Do not touch the bulb with bare hands. If this happens, clean the lamp with denatured alcohol and wipe it with a lint free cloth before installation.
3. The lamp generates UV radiation. Never operate the lamp without appropriate shielding.
4. When burning, the lamp operates at high pressure and there is a slight risk of arc tube rupture. The risk increases with age, temperature and improper handling of the lamp. Do not use the lamp any longer than its specified life.

5. Make sure the lamp is located in the center of the reflector for the best spot. Adjust lamp position by screws A, B and C.

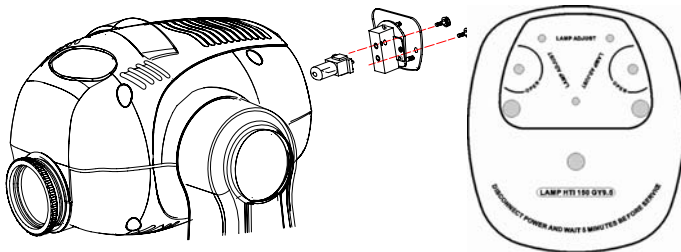
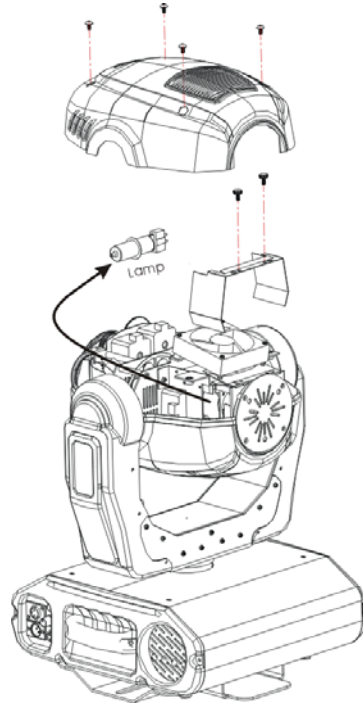

IM-7S

IM-8S

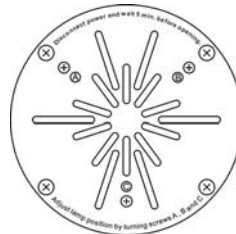

5.5 DMX512 Connection

The DMX512 is widely used in intelligent lighting control, with a maximum of 512 channels.

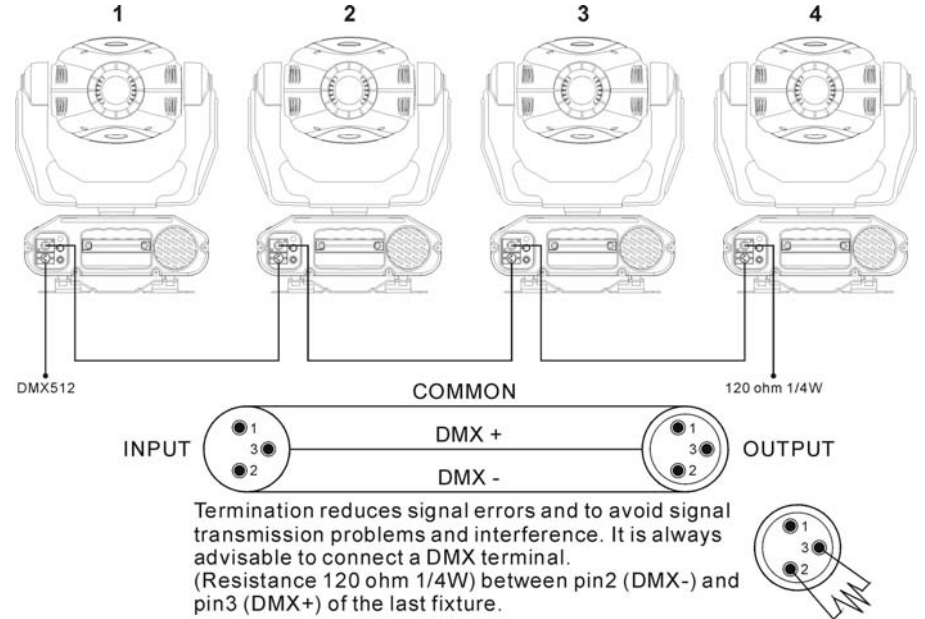









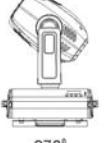











7E

1. If you use a controller with 5 pins DMX connector, you need to use a 5 to 3 pin adapter.
2. At last unit, the DMX cable has to be terminated with a terminator. Solder a 120-ohm 1/4W resistor between pin 2(DMX-) and pin 3(DMX+) into a 3-pin XLR-plug and plug it in the DMX-output of the last unit.
3. Connect the unit together in a "daisy chain" by XLR plug from the output of the unit to the input of the next unit. The cable can not branched or split to a "Y" cable. DMX512 is a very high-speed signal. Inadequate or damaged cables, soldered joints or corroded connectors can easily distort the signal and shut down the system.
4. The DMX output and input connectors are pass-through to maintain the DMX circuit, when power is disconnected to the unit.
5. Each lighting unit needs to have an address set to receive the data sent by the controller. The address number is between 0-511 (usually 0 & 1 are equal to 1).
6. The end of the DMX512 system should be terminated to reduce signal errors.
7. 3 pin XLR connectors are more popular than 5 pins XLR.
 - 3 pin XLR: Pin 1: GND, Pin 2: Negative signal (-), Pin 3: Positive signal (+)
 - 5 pin XLR: Pin 1: GND, Pin 2: Negative signal (-), Pin 3: Positive signal (+)

5.4 DMX512 Configuration

* IM-7S without Channel 8 – Focus.

DMX512 Configuration				
Ch1	Ch2	Ch3	Ch4	
Pan	Tilt	Shutter/Shaking	Gobo	
 540°	 270°	248-255 Open 247 Fastest speed Shaking   132 Slowest speed shaking 131 Fastest speed shutter   16 Slowest speed shutter 008-015 Open 000-007 Blackout	255 Fastest speed Gobo change  128 Slowest speed Gobo change 112-127  096-111  080-095  064-079  048-063  032-047  016-031  000-015 	
Ch5		Ch6	Ch7	Ch8
Color		Gobo Rotation	Dimmer	Focus
Normal	Split	246-255 Stopped 245 Fastest speed clockwise   135 Slowest speed clockwise 121-127 Pink 113-120 Light Green 106-112 UVPurple+light Green 098-105 UV Purple 091-097 Blue+UV Purple 083-090 Blue 121-134 Stopped 120 Slowest speed counterclockwise   010 Fastest speed counterclockwise 000-009 Stopped	100%  0	255  0
255 Fastest speed Rainbow effect  128 Slowest speed Rainbow effect 116-127 Pink 103-115 Light Green 090-102 UV Purple 077-089 Blue 064-076 Orange 052-063 Yellow 039-051 Light Blue 026-038 Magenta 013-025 Green 000-012 White	128 Slowest speed Rainbow effect 121-127 Pink 113-120 Light Green 106-112 UVPurple+light Green 098-105 UV Purple 091-097 Blue+UV Purple 083-090 Blue 076-082 Orange+Blue 068-075 Orange 061-067 Yellow+Orange 053-060 Yellow 046-052 Light Blue+Yellow 038-045 Light Blue 031-037 Magenta+Light Blue 023-030 Magenta 016-022 Green+Magenta 008-015 Green 000-007 White			

4. How To Set The Unit

4.1 Control Panel

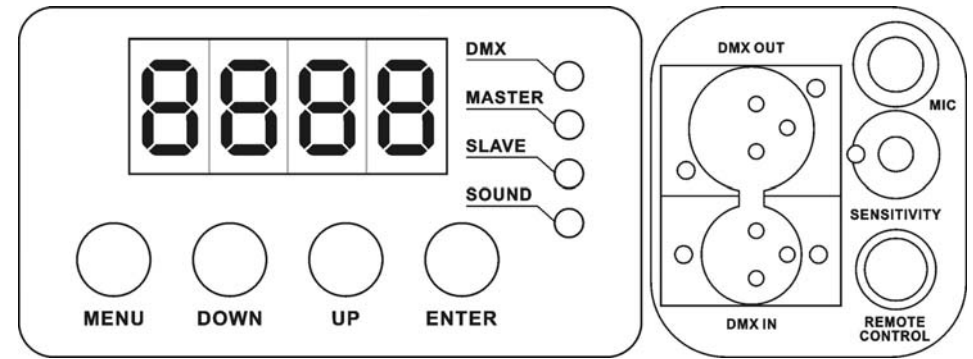

Display

To show the various menus and the selected functions .

LED

8E

DMX	On	DMX input present
MASTER	On	Master Mode
SLAVE	On	Slave Mode
SOUND	Flashing	Sound activation

Button

MENU	To select the programming functions
DOWN	To go backward in the selected functions
UP	To go forward in the selected functions
ENTER	To confirm the selected functions

Remote controller input

By connect to the 1/4" microphone jack to control the unit for Stand by, Function and Mode

Sensitivity

To adjust the sound sensitivity .

Microphone

To receive audio signal for sound activation .

DMX input/output

For DMX512 link, use 3-pin XLR plug cable to link the unit together.

4.2 Main Function

To select any of the pre-set functions, press the **MENU** button up to when the required one is shown on the display. Select the function by **ENTER** button and the display will blink. Use **DOWN** and **UP** button to change the mode. Once the required mode has been selected, press the **ENTER** button to setup or it will automatically return to the main functions without any change after idling 8 seconds. To go back to the functions without any change press the **MENU** button. The main functions are shown below:

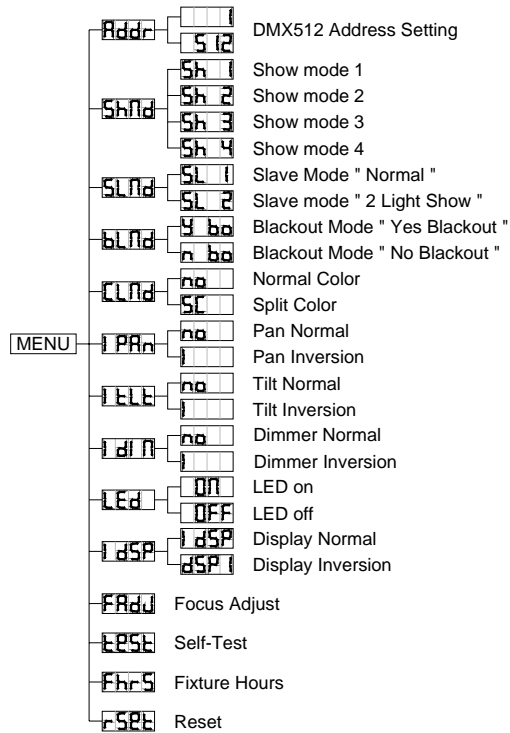

Addr DMX512 Address Setting

Press the **MENU** button up to when the **Addr** is showing on the display. Pressing **ENTER** button and the display will blink. Use **DOWN** and **UP** button to change the DMX512 address. Once the address has been selected, press the **ENTER** button to setup or automatically return to the main functions without any change after 8 seconds. To go back to the functions without any change press the **MENU** button again.

Stand by	Blackout the unit			
Function	Strobe 1.Gobo/Color sync. strobe 2.Sync. strobe 3.Two-light strobe	X/Y moving show mode selection (Show 1 ~ Show 4) Please refer to Show mode in 4.2 Main Function.	Color/Gobo selection 1. Hold on for gobo change. 2. Press shortly for color change.	X/Y moving setting 1.Pan position 2.Tilt position 3.Dimmer First set Master unit, then set Slave units' position.
Mode	Sound 1 (LED off)	Sound 2 (LED normal blinking)	Slow/Sound 3 (LED on)	Position/ Latch (LED fast blinking)

5.3.1 iSolution Operation

- ◆ Consistent DMX configuration enable iMove to be linked together with iRock and iShow and controlled at the same time.
- ◆ DMX address can be set remotely by iLead controller (please refer to the user manual of iLead controller). No need to calculate the DMX channels of each fixture in the chain.
- ◆ Automatic switching between DMX function and built-in stand alone programs.

5.3.2 DMX Controller

An universal DMX controller to control the units, you have to set DMX address from 1 to 512 channel so that the units can receive DMX signal.

Press the **MENU** button up to when the **Addr** is showing on the display. Pressing **ENTER** button and the display will blink. Use **DOWN** and **UP** button to change the DMX512 address. Once the address has been selected, press and keep **ENTER** button pressed up to when the display stops blinking or storing automatically 8 seconds later. To go back to the functions without any change press the **MENU** button again. Please refer to the following diagram to address your DMX512 channel for the first 4 units.

DMX address can be setting remotely by IL-0824 controller. No need to calculate the DMX channels of each fixture in the chain.



5. How To Control The Unit

You can operate the unit in three ways:

1. By master/slave built-in preprogram function
2. By easy controller
3. By iLead controller (please refer to the user guide of iLead) or by universal DMX controller

No need to turn the unit off when you change the DMX address, as new DMX address setting will be effected at once. Every time you turn the unit on, it will show IM8S / IM7S on the display and move all the motors to their 'home' position and you may hear some noises for about 20 seconds. After that the unit will be ready to receive DMX signal or run the built-in programs.

5.1 Master/Slave Built-In Preprogrammed Function

You can select blackout mode **BLNd** in **y ba** (yes blackout) or **n ba** (no blackout) mode while the unit is turned on. By linking the units in master/slave connection, the first unit will control the other units to give an automatic, sound activated, synchronized light show.

This function is good when you want an instant show. You have to select **Sh 1** (show 1) or **Sh 2** (show 2) or **Sh 3** (show 3) or **Sh 4** (show 4) mode by easy controller. Its DMX input jack will have nothing plugged into it, and Its master LED will be constantly on and sound LED will flash to the music. The other units will have to set in slave mode **SLNd** and select **SL 1** (normal) or **SL 2** (2 light show) mode, Their DMX cables plugged into the DMX input jacks (daisy chain) and the slave LED lights will constantly on.

2-light show

In **SLNd** (slave mode), **SL 1** means the unit works normally and **SL 2** means 2-light show. In order to create a great light show, you can set **SL 2** on the second unit to get contrast movement to each other, even if you have two units only.

5.2 Easy Controller

The easy remote controller is used only in master/slave mode. By connecting to the 1/4" microphone jack of the first unit, you will find that the remote control on the first unit will control all the other units for Stand by, Function and Mode.

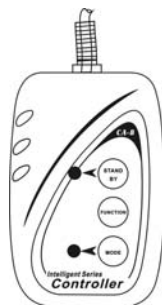

ShNd

Show Mode

Press the **MENU** button up to when the **ShNd** is showing on the display. Pressing **ENTER** button and the display will blink. Use **DOWN** and **UP** button to select the **Sh 1** (show 1) or **Sh 2** (show 2) or **Sh 3** (show 3) or **Sh 4** (show 4) mode. Once the mode has been selected, press the **ENTER** button to setup or automatically return to the main functions without any change after 8 seconds. To go back to the functions without any change press the **MENU** button again.

Sh 1

Show 1 mode - Fixture is placed on the floor. Tilt movement angle 210°.

Sh 2

Show 2 mode - Fixture is fixed under ceiling. Tilt movement angle 90°.

Sh 3

Show 3 mode - Fixture is placed on the speaker, The spot is always projecting to the audience's direction; i.e in front of the stage. Pan movement angel (left to right to left): 160°. Tilt movement angel: 90° (60° above horizon; 30° below horizon.)

Sh 4

Show 4 mode - Fixture is fixed under ceiling. The spot is mainly projecting in front of the stage. Pan movement angel (left to right to left): 160°. Tilt movement angel: 90° (vertically, front 75°; back 15°)

10E

SLNd

Slave Mode

Press the **MENU** button up to when the **SLNd** is showing on the display. Pressing **ENTER** button and the display will blink. Use **DOWN** and **UP** button to select the **SL 1** (normal) or **SL 2** (2 light show) mode. Once the mode has been selected, press the **ENTER** button to setup or automatically return to the main functions without any change after 8 seconds. To go back to the functions without any change press the **MENU** button again.

BLNd

Blackout Mode

Press the **MENU** button up to when the **BLNd** is showing on the display. Pressing **ENTER** button and the display will blink. Use **DOWN** and **UP** button to select the **y ba** (yes blackout) or **n ba** (no blackout) mode. Once the mode has been selected, press the **ENTER** button to setup or automatically return to the main functions without any change after 8 seconds. To go back to the functions without any change press the **MENU** button again.

CLNd Color Mode

Press the **MENU** button up to when the **CLNd** is showing on the display. Pressing **ENTER** button and the display will blink. Use **DOWN** and **UP** button to select the **no** (normal) or **SC** (split color) mode. Once the mode has been selected, press the **ENTER** button to setup or automatically return to the main functions without any change after 8 seconds. To go back to the functions without any change press the **MENU** button again.

IPRn Pan Inversion

Press the **MENU** button up to when the **IPRn** is showing on the display. Pressing **ENTER** button and the display will blink. Use **DOWN** and **UP** button to select the **no** (normal) or **I** (pan inversion) mode. Once the mode has been selected, press the **ENTER** button to setup or automatically return to the main functions without any change after 8 seconds. To go back to the functions without any change press the **MENU** button again.

ITLl Tilt Inversion

Press the **MENU** button up to when the **ITLl** is showing on the display. Pressing **ENTER** button and the display will blink. Use **DOWN** and **UP** button to select the **no** (normal) or **I** (tilt inversion) mode. Once the mode has been selected, press the **ENTER** button to setup or automatically return to the main functions without any change after 8 seconds. To go back to the functions without any change press the **MENU** button again.

IDIn Dimmer Inversion

Press the **MENU** button up to when the **IDIn** is shown on the display. Pressing **ENTER** button and the display will blink. Use **DOWN** and **UP** button to select the **no** (normal) or **I** (dimmer inversion) mode. Once the mode has been selected, press the **ENTER** button to setup or automatically return to the main functions without any change after 8 seconds. To go back to the functions without any change press the **MENU** button again.

LEd Led Display

Press the **MENU** button up to when the **LEd** is showing on the display. Pressing **ENTER** button and the display will blink. Use **DOWN** and **UP** button to select the **ON** (Led on) or **OFF** (Led off) mode. Once the mode has been selected, press the **ENTER** button to setup or automatically return to the main functions without any change after 8 seconds. To go back to the functions without any change press the **MENU** button again.

IDSP Display Inversion

It is good for you to install the unit on the floor or under ceiling. Press the **MENU** button up to when the **IDSP** is blinking on the display. Use the **ENTER** button to change to the mode **dSPi** (display inversion), It will automatically store after 8 seconds. Or press the **ENTER** button again return to the mode **IDSP** (display normal). To go back to the functions press the **MENU** button.

IDSP Display normal mode for the fixture putting on the floor.

dSPi Display inversion mode for the fixture fixing under ceiling.

FADU Focus Adjust

Press the **MENU** button up to when the **FADU** is blinking on the display. Pressing **ENTER** button, the unit will focus on tilt 90°, and then the unit will focus on pan 0°, pan 90°, pan 180°, pan 270° in every pressing **ENTER** button. Use **DOWN** and **UP** button to adjust focus. To go back to the functions press the **MENU** button again.

TEST Self-Test

11E Press the **MENU** button up to when the **TEST** is blinking on the display. Pressing **ENTER** button and the unit will run self-test by built-in program. To go back to the functions press the **MENU** button again.

FhrS Fixture Hours

Press the **MENU** button up to when the **FhrS** is blinking on the display. Pressing **ENTER** button and the display will show the number of working hours of the unit. To go back to the functions press the **MENU** button again.

rSet Reset

Press the **MENU** button up to when the **rSet** is blinking on the display. Pressing **ENTER** button and all channels of the unit will return to their standard position. To go back to the functions press the **MENU** button again.