

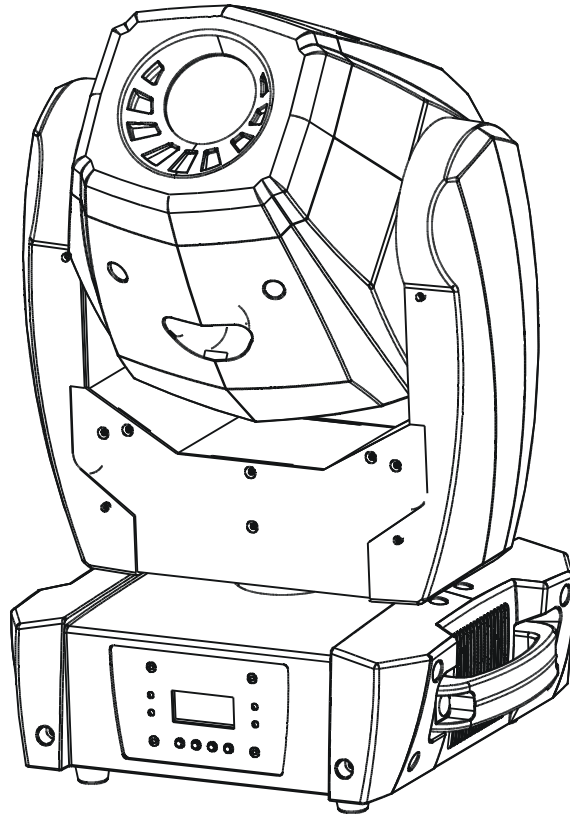

iMove 50SR



LED-MS50A

User Guide

Professional Entertainment Technology

TABLE OF CONTENTS

1. Safety Instruction
2. Technical Specification
3. How To Set The Unit
4. How To Control The Unit
5. Troubleshooting
6. Fixture Cleaning

1. Safety Instruction



WARNING

Please read carefully the instruction, which includes important information about the installation, usage and maintenance.

- Please keep this User Guide for future consultation. If you sell the unit to another user, be sure that they also receive this instruction booklet.
- Unpack and check carefully there is no transportation damage before using the unit.
- Before operating, ensure that the voltage and frequency of power supply match the power requirements of the unit.
- It's important to ground the yellow/green conductor to earth in order to avoid electric shock.
- The unit is for indoor use only. Use only in a dry location.
- The unit must be installed in a location with adequate ventilation, at least 50cm from adjacent surfaces. Be sure that no ventilation slots are blocked.
- Disconnect main power before replacement or servicing.
- Make sure there is no flammable materials close to the unit while operating as it is fire hazard.
- Use safety cable when fixes this unit. Don't handle the unit by taking its head only, but always by taking its base.
- Maximum ambient temperature is t_a : 40°C. Don't operate it where the temperature is higher than this.
- Unit surface temperature may reach up to 85°C. Don't touch the housing bare-hand during its operation. Turn off the power and allow about 15 minutes for the unit to cool down before replacing or serving.
- In the event of serious operating problem, stop using the unit immediately. Never try to repair the unit by yourself. Repairs carried out by unskilled people can lead to damage or malfunction. Please contact the nearest authorized technical assistance center. Always use the same type spare parts.
- Do not touch any wire during operation as high voltage might be causing electric shock.

Warning

- To prevent or reduce the risk of electrical shock or fire, do not expose the unit to rain or moisture.
- Do not open the unit within five minutes after switching off.
- The housing, the lenses, or the ultraviolet filter must be replaced if they are visibly damaged.

Caution

There are no user serviceable parts inside the unit. Do not open the housing or attempt any repairs yourself. In the unlikely event your unit may require service, please contact your nearest dealer.

Installation

The unit should be mounted via its screw holes on the bracket. Always ensure that the unit is firmly fixed to avoid vibration and slipping while operating. And make sure that the structure to which you are attaching the unit is secure and is able to support a weight of 10 times of the unit's weight. Also always use a safety cable that can hold 12 times of the weight of the unit when installing the fixture.

The equipment must be fixed by professionals. And it must be fixed at a place where is out of the touch of people and has no one pass by or under it.

2. Technical Specification

- Genesis Move 50 is the combination of the latest high powered LED technology, excellent optics and great features.
- DMX control: 15/16 channels.

- 3 operation modes: DMX, Master/Slave, Sound Activation.
- Great built-in lighting programs under master/slave mode triggered by music.
- Optional CA-8 easy controller or CA-9 RTX (wireless easy control kit) for instant lighting shows.
- Rotating gobo wheel with 7 gobos plus white, fixed gobo wheel with 8 gobos plus open.
- Color wheel with 7 colors plus white.
- Pan 540°; Tilt 270°.
- Automatic Pan/Tilt position correction.
- Smooth 0~100% dimming and variable strobe speeds.
- Indexable, replaceable 3-facet rotating prism.
- Auto focus.
- Beam angle: 17°.
- LCD display for easy navigation and addressing.
- Perfect for disco, club, bar, parties and Mobile DJs.

Voltage: 100V~240V, 50/60Hz

Power consumption: 130W

Light source: 1×50W White LED

Dimension: 299X247X437 mm

Φ Rotating gobo =22 mm

Φ Fixed gobo =24 mm

Weight: 10.2 kg

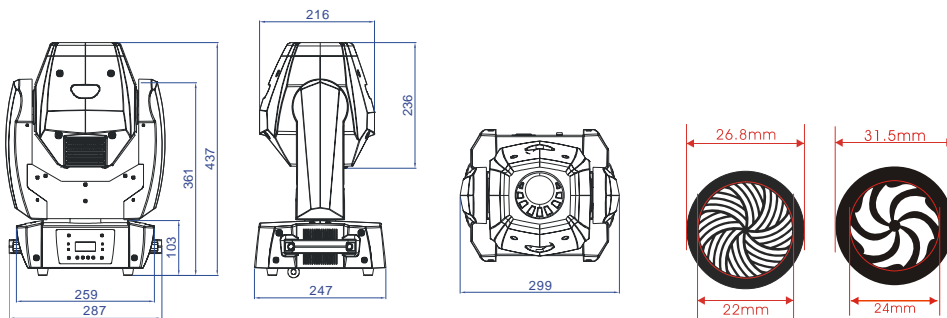

Photometric diagram:

White	25000	6077	2602	1435	944	(lux)
Yellow	18000	4511	2050	1133	717	
Cambridge blue	6130	1599	680	394	251	
Dark green	6305	1620	737	404	259	
Red	1528	380	173	96	65	
Purplish red	996	243	114	63	42	
Blue	1936	494	221	121	81	
Orange	5920	1545	683	384	248	

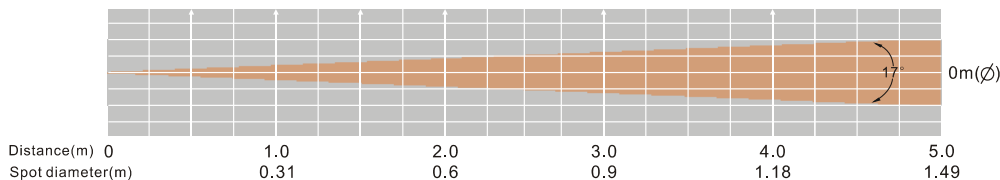

3. How To Set The Unit

3.1 Control panel

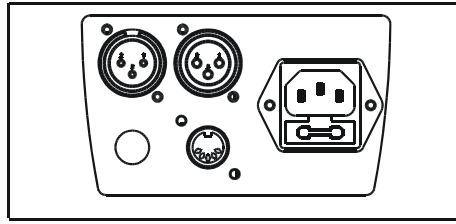
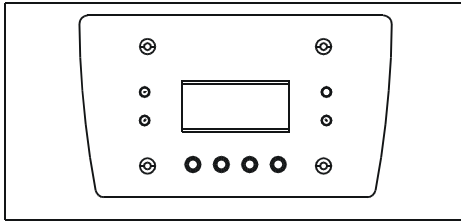

Display

To show the various menus and the selected functions

LED

DMX	On	DMX input present
MASTER	On	Master Mode
SLAVE	On	Slave Mode
SOUND	Flashing	Sound activation

Button

MENU	To select the programming functions
DOWN	To go backward in the selected functions
UP	To go forward in the selected functions
ENTER	To confirm the selected functions

Only for remote control

Connecting with CA-8/CA-9/CA-9RTX to control the unit for Stand by, Function and Mode function.

Mains input

Connect to power supply.

DMX input/output

For DMX512 link, use 3/5-pin XLR cable to link the unit together.

3.2 Main Function

To select any of the given functions, press the **MENU** button up to when the required one is showing on the display. Select the function by **ENTER** button and the display will blink. Use **DOWN** and **UP** button to change the mode. Once the required mode has been selected, press the **ENTER** button to setup, to go back to the functions without any change press the **MENU** button again. Hold and press the **MENU** button about one second or wait for one minute to exit the menu mode.

The main functions are showing below:

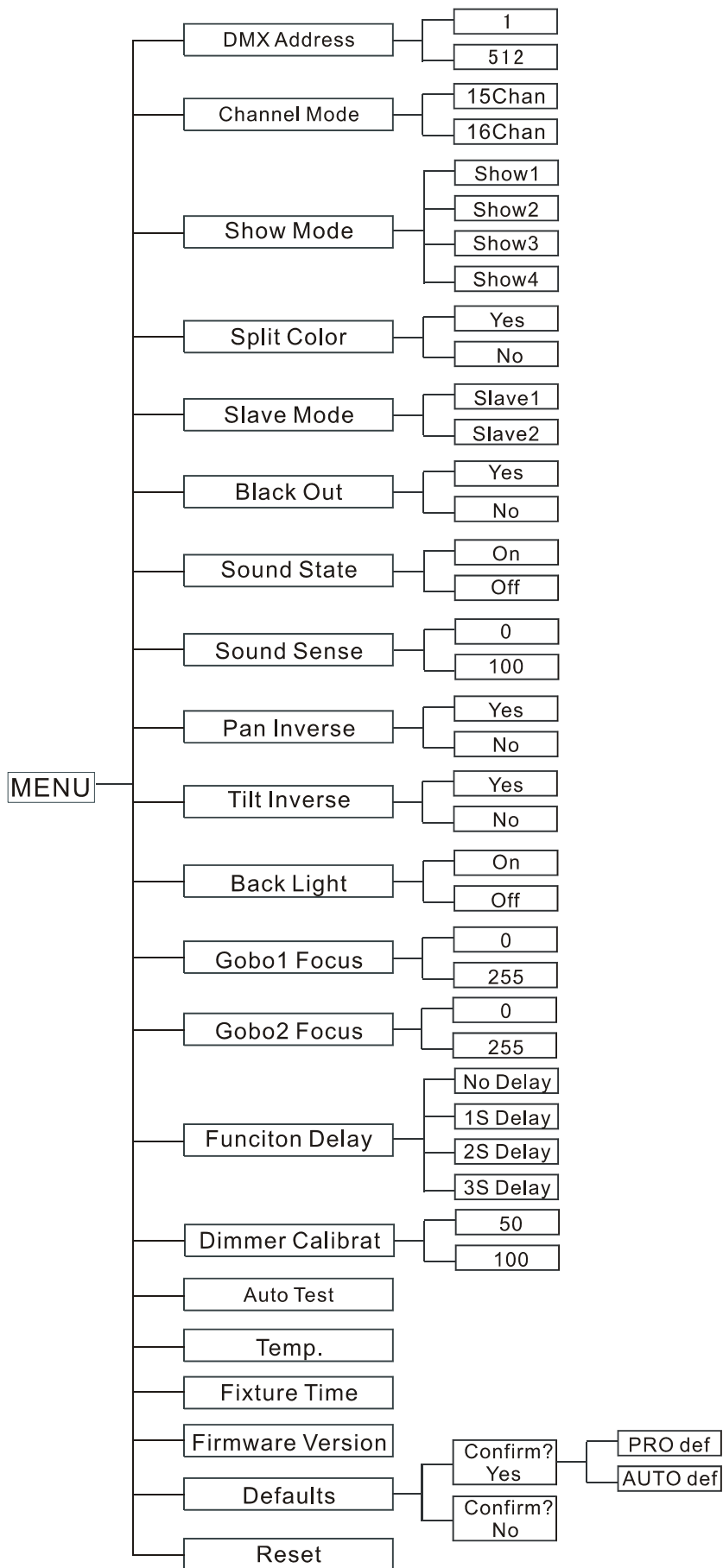

DMX Address

Select **DMX Address**, press **ENTER** button to confirm, the present address will blink on the display. Use **UP** and **DOWN** button to adjust the address from **1** to **512**. Once the address has been selected, press the **ENTER** button to setup, to go back to the functions without any change press the **MENU** button again. Hold and press the **MENU** button about one second or wait for one minute to exit the menu mode.

Channel Mode

Select **Channel Mode**, press **ENTER** button to confirm, present mode will blink on the display. Use **DOWN** and **UP** button to select the **15 Chan** (15 Channel Mode) or **16 Chan** (16 Channel Mode) mode. Once the mode has been selected, press the **ENTER** button to setup, to go back to the functions without any change press the **MENU** button again. Hold and press the **MENU** button about one second or wait for one minute to exit the menu mode.

Show Mode

Select **Show Mode**, press **ENTER** button to confirm, present mode will blink on the display. Use **DOWN** and **UP** button to select the **Show 1** or **Show 2** or **Show 3** or **Show 4** mode. Once the mode has been selected, press the **ENTER** button to setup, to go back to the functions without any change press the **MENU** button again. Hold and press the **MENU** button about one second or wait for one minute to exit the menu mode.

Split Color Mode

Select **Split Color Mode**, press **ENTER** button to confirm, present mode will blink on the display. Use **DOWN** and **UP** button to select the **Yes** (Split Color mode) or **No** (normal) mode. Once the mode has been selected, press the **ENTER** button to setup, to go back to the functions without any change press the **MENU** button again. Hold and press the **MENU** button about one second or wait for one minute to exit the menu mode.

Slave Mode

Select **Slave Mode**, press **ENTER** button to confirm, present mode will blink on the display. Use **DOWN** and **UP** button to select the **Slave 1** (normal) or **Slave 2** (2 light show) mode. Once the mode has been selected, press the **ENTER** button to setup, to go back to the functions without any change press the **MENU** button again. Hold and press the **MENU** button about one second or wait for one minute to exit the menu mode.

Black Out

Select **Slave Mode**, press **ENTER** button to confirm, present mode will blink on the display. Use **DOWN** and **UP** button to select the **Yes** (yes blackout) or **No** (no blackout) mode. Once the mode has been selected, press the **ENTER** button to setup, to go back to the functions without any change press the **MENU** button again. Hold and press the **MENU** button about one second or wait for one minute to exit the menu mode.

Sound State

Select **Sound State**, press **ENTER** button to confirm, present mode will blink on the display. Use **DOWN** and **UP** button to select the **On** (sound on) or **Off** (sound off) mode. Once the mode has been selected, press the **ENTER** button to setup, to go back to the functions without any change press the **MENU** button again. Hold and press the **MENU** button about one second or wait for one minute to exit the menu mode.

Sound Sense

Select **Sound Sense**, press ENTER button to confirm, present mode will blink on the display. Use **DOWN** and **UP** button to select the **0 ...100** mode. Once the mode has been selected, press the **ENTER** button to setup, to go back to the functions without any change press the **MENU** button again. Hold and press the **MENU** button about one second or wait for one minute to exit the menu mode.

Pan Inverse

Select **Pan Inverse**, press ENTER button to confirm, present mode will blink on the display. Use **DOWN** and **UP** button to select the **Yes** (pan inversion) or **No** (normal) mode. Once the mode has been selected, press the **ENTER** button to setup, to go back to the functions without any change press the **MENU** button again. Hold and press the **MENU** button about one second or wait for one minute to exit the menu mode.

Tilt Inverse

Select **Pan Inverse**, press ENTER button to confirm, present mode will blink on the display. Use **DOWN** and **UP** button to select the **Yes** (tilt inversion) or **No**(normal) mode. Once the mode has been selected, press the **ENTER** button to setup, to go back to the functions without any change press the **MENU** button again. Hold and press the **MENU** button about one second or wait for one minute to exit the menu mode.

Back Light

Select **Back Light**, press ENTER button to confirm, present mode will blink on the display. Use **DOWN** and **UP** button to select the **On** (Led on) or **Off** (Led off) mode. Once the mode has been selected, press the **ENTER** button to setup, to go back to the functions without any change press the **MENU** button again. Hold and press the **MENU** button about one second or wait for one minute to exit the menu mode.

Gobo1 Focus

Select **Gobo1 Focus**, press ENTER button to confirm, present mode will blink on the display. Use **DOWN** and **UP** button to select the **0 ...255** mode. Once the mode has been selected, press the **ENTER** button to setup, to go back to the functions without any change press the **MENU** button again. Hold and press the **MENU** button about one second or wait for one minute to exit the menu mode.

Gobo2 Focus

Select **Gobo2 Focus**, press ENTER button to confirm, present mode will blink on the display. Use **DOWN** and **UP** button to select the **0 ...255** mode. Once the mode has been selected, press the **ENTER** button to setup, to go back to the functions without any change press the **MENU** button again. Hold and press the **MENU** button about one second or wait for one minute to exit the menu mode.

Function Delay

Select **Function Delay**, press ENTER button to confirm, present mode will blink on the display. Use **DOWN** and **UP** button to select the **No Delay** or **1S/2S/3S Delay** (Wait for 1/2/3 seconds before these Functions of 15/16 CH are activated/deactivated) mode. Once the mode has been selected, press the **ENTER** button to setup, to go back to the functions without any change press the **MENU** button again. Hold and press the **MENU** button about one second or wait for one minute to exit the menu mode.

Dimmer Calibrate

Press the **MENU** button to show **Dimmer Calibrate** on the display. Press the **ENTER** button and the display will blink. Use the **DOWN** and **UP** button to calibrate the dimmer for a maximum output from **50** (limited to 50% of the really max. output) to **100** (maximum output is not limited). Once the mode has been selected, press the **ENTER** button to setup, to go back to the functions without any change press the

MENU button again. Hold and press the **MENU** button about one second or wait for one minute to exit the menu mode.

Auto-Test

Press the **MENU** button up to when the **Auto-Test** is blinking on the display. Pressing **ENTER** button and the unit will run self-test by built-in program. To go back to the functions press the **MENU** button again. Hold and press the **MENU** button about one second or wait for one minute to exit the menu mode.

Temperature

Press the **MENU** button up to when the **Temperature Test** is blinking on the display. Pressing **ENTER** button and the display will show the temperature of the unit. To go back to the functions press the **MENU** button again. Hold and press the **MENU** button about one second or wait for one minute to exit the menu mode.

When the temperature of the fixture is up to 50°, the display will show

HIGH LED 50°

When the temperature of the fixture is higher than 60°, the LED will be off and the display will show

LED OFF OVER TEMP

Fixture Time

Press the **MENU** button up to when the **Fixture Time** is blinking on the display. Pressing **ENTER** button and the display will show the number of working hours of the unit. To go back to the functions press the **MENU** button again. Hold and press the **MENU** button about one second or wait for one minute to exit the menu mode.

Firmware Version

Press the **MENU** button up to when the **Firmware version** is blinking on the display. Pressing **ENTER** button and the display will show the version of software of the unit. To go back to the functions press the **MENU** button again. Hold and press the **MENU** button about one second or wait for one minute to exit the menu mode.

Defaults Setting

Press the **MENU** button to show **Defaults** on the display. Press the **ENTER** button and the display will blink. Use the **DOWN** and **UP** button to select the **Confirm? YES** or **Confirm? No**. Once the **Confirm? Yes** has been selected, press the **ENTER** button and use the **UP** and **Down** button to select the **PRO Def** or **AUTO Def**.

PRO Defaults: For professional users, detailed explanation as followings:

- ☞ **Channel Mode** → 16 Chan
- ☞ **Split Color Mode** → Yes
- ☞ **Slave Mode** → Slave 1
- ☞ **Black Out** → Yes
- ☞ **Sound State** → Off
- ☞ **Sound Sense** → 90

- ☞ **Pan Inverse** → No
- ☞ **Tilt Inverse** → No
- ☞ **Back Light** → Off
- ☞ **Function Delay** → 3S Delay

AUTO Defaults: Mostly automatic mode, for non professional users, detailed explanation as followings:

- ☞ **Channel Mode** → 15 Chan
- ☞ **Split Color Mode** → No
- ☞ **Slave Mode** → Slave 1
- ☞ **Black Out** → No
- ☞ **Sound State** → On
- ☞ **Sound Sense** → 90
- ☞ **Pan Inverse** → No
- ☞ **Tilt Inverse** → No
- ☞ **Back Light** → On
- ☞ **Function Delay** → 3S Delay

(**Notice:** Other settings are NOT changed while choosing Defaults Setting!)

Press the **ENTER** and the corresponding functions will set to defaults setting, to go back to the functions without any change press the **MENU** button again. Hold and press the **MENU** button about one second or wait for one minute to exit the menu mode.

Reset

Press the **MENU** button up to when the **Reset** is blinking on the display. Pressing **ENTER** button and all channels of the unit will return to their standard position.

3.3 Home Position Adjust

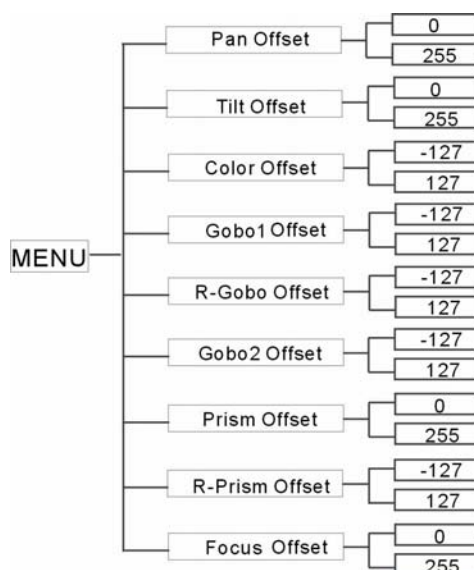

In the main functions, hold **Enter** button for at least 3 seconds into offset mode, use **DOWN** and **UP** button up to chose **Pan Offset**, **Tilt Offset**, **Color Offset**, **Gobo1 Offset**, **R-Gobo Offset**, **Gobo2 Offset**, **Prism Offset**, **R-Prism Offset** or **Focus Offset**, pressing **ENTER** Pressing **ENTER** button and the display will

blink. Use **DOWN** and **UP** button to adjust the home position of the Pan, Tilt, color, Gobo1, R-Gobo, Gobo2, Prism, R-Prism, or Focus. Once the position has been selected, press the **ENTER** button to setup, to go back to the functions without any change press the **MENU** button again. Hold and press the **MENU** button about one second or wait for one minute to exit the menu mode.

4. How To Control The Unit

You can operate the unit in three ways:

1. Master/slave built-in preprogram function
2. Easy controller
3. Universal DMX controller

No need to turn the unit off when you change the DMX address, as new DMX address setting will be effect at once. Every time you turn the unit on, it will show “LED-MS50” on the display and move all the motors to their ‘home’ position and you may hear some noises for about 20 seconds. After that the unit will be ready to receive DMX signal or run the built in programs.

4.1 Master/Slave Built In Preprogrammed Function

By linking the units in master/slave connection, the first unit will control the other units to give an automatic, sound activated, synchronized light show. This function is good when you want an instant show. You have to set the first unit in master mode **Show Mode** and select **show 1** or **show 2** or **show 3** or **show 4** mode. Its DMX input jack will have nothing plugged into it, and its master LED will be constantly on and sound LED will flash to the music. The other units will have to set in **slave mode** and select **Slave 1** (normal) or **Slave 2** (2 light show) mode, Their DMX cables plugged into the DMX input jacks (daisy chain) and the slave led lights will constantly on.

2-light show

In **slave mode**, **Slave 1** means the unit works normally and **Slave 2** means 2-light show. In order to create a great light show, you can set **Slave 2** on the second unit to get contrast movement to each other, even if you have two units only.

4.2 Easy Controller

The easy remote control is used only in master/slave mode. By connecting to the 1/4” microphone jack of the first unit, you will find that the remote controller on the first unit will control all the other units in Stand by, and Mode selection.

Stand By	Blackout the unit		
Function	1. Sync. Strobe 2. Async strobe 3. Sound Strobe	Show 1-4	1. Press to select color 2. Hold to select gobo
Mode	Sound (LED OFF)	Show (LED Slow Blinking)	LED ON

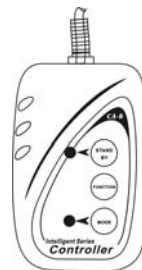

4.3 DMX Controller

By using a universal DMX controller to control the units, you will need to set DMX address from 1 to 512 so that the units can receive DMX signal.

Press the **MENU** button up to when the **DMX Address** is showing on the display. Pressing **ENTER** button and the display will blink. Use **DOWN** and **UP** button to change the DMX512 address. Once the address has been selected, press the **ENTER** button to setup, to go back to the functions without any change press

the **MENU** button again. Hold and press the **MENU** button about one second or wait for one minute to exit the menu mode. Please refer to the following diagram to address your DMX512 channel for the first 4 units:







Channel mode	Unit 1 Address	Unit 2 Address	Unit 3 Address	Unit 4 Address
15channels	1	16	31	46
16channels	1	17	33	49

4.4 DMX 512 Configuration

15 channel modes:

15 Channel Mode				
Ch1	Ch2	Ch3	Ch4	Ch5
Pan	Pan Fine	Tilt	Tilt Fine	Pan/Tilt Speed
255 540° 0 0°	255 0	255 270° 0 0°	255 0	255 Slow 0 Fast
Ch6	Ch7	Ch8		Ch9
Dimmer	Shutter	Color Wheel (Normal)	Color Wheel (Split Color)	Gobo 1
255 100% 0 0%	248-255 Open 240-247 Random Strobe 232-239 Open 190-231 Slow Close Fast Open 182-189 Open 140-181 Fast Close Slow Open 132-139 Open Fast 16-131 8-15 Slow Open 0-7 Blackout	255 Rotation Fast 194 Rotation Slow 190-193 Stop 189 Rotation Slow 128 Rotation Fast 099-127 Color7 085-098 Color6 071-084 Color5 057-070 Color4 043-056 Color3 029-042 Color2 015-028 Color1 000-014 White	255 Rotation Fast 194 Rotation Slow 190-193 Stop 189 Rotation Slow 128 Rotation Fast 105-127 Color14 098-104 Color13 090-097 Color12 083-089 Color11 075-082 Color10 068-074 Color9 060-067 Color8 053-059 Color7 045-052 Color6 038-044 Color5 030-037 Color4 023-029 Color3 015-022 Color2 008-014 Color1 000-007 White	255 Rotation Fast 194 Rotation slow 190-193 Stop 189 Rotationslow 128 Rotation Fast 119-127 Gobo7 shaking 110-118 Gobo6 shaking 101-109 Gobo5 shaking 092-100 Gobo4 shaking 083-091 Gobo3 shaking 074-082 Gobo2 shaking 064-073 Gobo1 shaking 056-063 Gobo7 048-055 Gobo6 040-047 Gobo5 032-039 Gobo4 024-031 Gobo3 016-023 Gobo2 008-015 Gobo1 000-007 White

15 Channel Mode

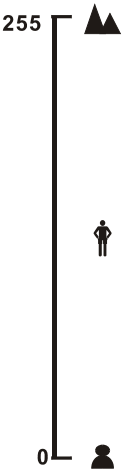
Ch10	Ch11	Ch12	Ch13	Ch14	Ch15
R-Gobo 1	Gobo 2	Prism	R-Prism	Focus	Function
255 Rotation Fast  194 Rotation Slow 190-193 Stopped 189 Rotation Slow  128 Rotation Fast 000-127 Index	255 Rotation Fast  194 Rotation Slow 190-193 Stop 189 Rotation Slow  128 Rotation Fast 120-127 Gobo8 shaking 112-119 Gobo7 shaking 104-111 Gobo6 shaking 096-103 Gobo5 shaking 088-095 Gobo4 shaking 080-087 Gobo3 shaking 072-079 Gobo2 shaking 064-071 Gobo1 shaking 057-063 Gobo8 050-056 Gobo7 043-049 Gobo6 036-042 Gobo5 029-035 Gobo4 022-028 Gobo3 015-021 Gobo2 008-014 Gobo1 000-007 White	 008-255 Prism On 000-007 Prism Off	 255 Rotation Fast  194 Rotation Slow 190-193 Stopped 189 Rotation Slow  128 Rotation Fast 000-127 Stopped		250-255 Sound Active 210-249 No Function 200-209 Reset All 130-199 No Function 120-129 Disable Blackout while Gobo Change 110-119 Enable Blackout while Gobo Change 100-109 Disable Blackout while Color Change 090-099 Enable Blackout while Color Change 080-089 Disable Blackout while Pan/Tilt Move 070-079 Enable Blackout while Pan/Tilt Move 000-069 No Function

Gobo1:



Gobo2:









16 channel modes:

16 Channel Mode

Ch1	Ch2	Ch3	Ch4	Ch5
Pan	Tilt	Pan/Tilt Speed	Dimmer	Shutter
<p>255 540° 0 0°</p>	<p>255 270° 0 0°</p>	<p>255 Slow 0 Fast</p>	<p>255 100% 0 0%</p>	<p>248-255 Open 240-247 Random Strobe 232-239 Open 190-231 Slow Close Fast Open 182-189 Open 140-181 Fast Close Slow Open 132-139 Open Fast 16-131 Slow 8-15 Open 0-7 Blackout</p>

Ch6		Ch7	Ch8	Ch9
Color Wheel (Normal)	Color Wheel (Split Color)	No Function	Gobo 2	Gobo 1
<p>255 Rotation Fast</p> <p>194 Rotation Slow 190-193 Stop 189 Rotation Slow</p> <p>128 Rotation Fast 099-127 Color7 085-098 Color6 071-084 Color5 057-070 Color4 043-056 Color3 029-042 Color2 015-028 Color1 000-014 White</p>	<p>255 Rotation Fast</p> <p>194 Rotation Slow 190-193 Stop 189 Rotation Slow</p> <p>128 Rotation Fast 105-127 Color14 098-104 Color13 090-097 Color12 083-089 Color11 075-082 Color10 068-074 Color9 060-067 Color8 053-059 Color7 045-052 Color6 038-044 Color5 030-037 Color4 023-029 Color3 015-022 Color2 008-014 Color1 000-007 White</p>	No Function	<p>255 Rotation Fast</p> <p>194 Rotation Slow 190-193 Stop 189 Rotation Slow</p> <p>128 Rotation Fast 120-127 Gobo8 shaking 112-119 Gobo7 shaking 104-111 Gobo6 shaking 096-103 Gobo5 shaking 088-095 Gobo4 shaking 080-087 Gobo3 shaking 072-079 Gobo2 shaking 064-071 Gobo1 shaking 057-063 Gobo8 050-056 Gobo7 043-049 Gobo6 036-042 Gobo5 029-035 Gobo4 022-028 Gobo3 015-021 Gobo2 008-014 Gobo1 000-007 White</p>	<p>255 Rotation Fast</p> <p>194 Rotation Slow 190-193 Stop 189 Rotation Slow</p> <p>128 Rotation Fast 119-127 Gobo7 shaking 110-118 Gobo6 shaking 101-109 Gobo5 shaking 092-100 Gobo4 shaking 083-091 Gobo3 shaking 074-082 Gobo2 shaking 064-073 Gobo1 shaking 056-063 Gobo7 048-055 Gobo6 040-047 Gobo5 032-039 Gobo4 024-031 Gobo3 016-023 Gobo2 008-015 Gobo1 000-007 White</p>

16 Channel Mode						
Ch10	Ch11	Ch12	Ch13	Ch14	Ch15	Ch16
R-Gobo 1	Prism	R-Prism	Focus	Pan Fine	Tilt Fine	Function
255 Rotation Fast  194 Rotation Slow 190-193 Stopped 189 Rotation Slow  128 Rotation Fast 000-127 Index	008-255 Prism On 000-007 Prism Off	255 Rotation Fast  194 Rotation Slow 190-193 Stopped 189 Rotation Slow  128 Rotation Fast 000-127 Stopped	255   0 	255 0	255 0	250-255 Sound Active 210-249 No Function 200-209 Reset All 130-199 No Function 120-129 Disable Blackout while Gobo Change 110-119 Enable Blackout while Gobo Change 100-109 Disable Blackout while Color Change 090-099 Enable Blackout while Color Change 080-089 Disable Blackout while Pan/Tilt Move 070-079 Enable Blackout while Pan/Tilt Move 000-069 No Function



4.5 DMX512 Connection

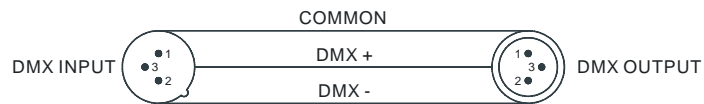
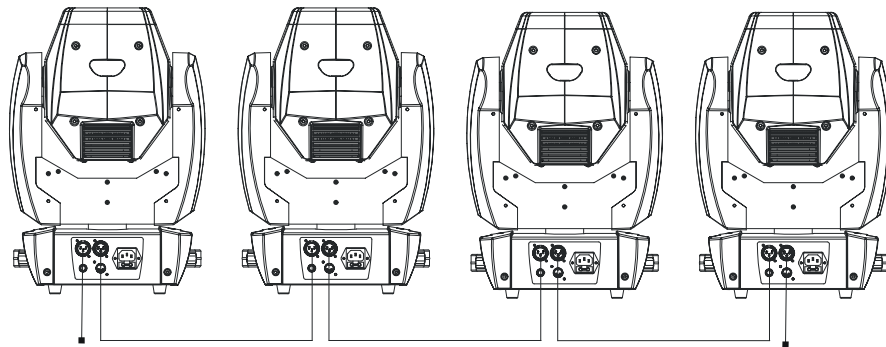

Termination reduces signal error and avoids signal transmission problems and interference. It is always advisable to connect a DMX terminal. (Resistance 120 ohm 1/4W) between pin2(DMX-) and pin3(DMX+) of the last fixture.



1. If you using a controller with 5 pins DMX output, you need to use a 5 to 3 pin adapter-cable.
2. At last unit, the DMX cable has to be terminated with a terminator. Solder a 120 ohm 1/4W resistor between pin 2(DMX-) and pin 3(DMX+) into a 3-pin XLR-plug and plug it in the DMX-output of the last unit.
3. Connect the unit together in a `daisy chain` by XLR plug from the output of the unit to the input of the next unit. The cable can not branched or split to a `Y` cable. DMX 512 is a very high-speed signal.

Inadequate or damaged cables, soldered joints or corroded connectors can easily distort the signal and shut down the system.

4. The DMX output and input connectors are pass-through to maintain the DMX circuit, when one of the units' power is disconnected.
5. Each lighting unit needs to have an address set to receive the data sent by the controller. The address number is between 0-511 (usually 0 & 1 are equal to 1).
6. The end of the DMX 512 system should be terminated to reduce signal errors.
7. 3 pin XLR connectors are more popular than 5 pin XLR.
3 pin XLR: Pin 1: GND, Pin 2: Negative signal (-), Pin 3: Positive signal (+)
5 pin XLR: Pin 1: GND, Pin 2: Negative signal (-), Pin 3: Positive signal (+), Pin 4/Pin 5: Not used.

5. Troubleshooting

Following are a few common problems that may occur during operation. Here are some suggestions for easy troubleshooting:

A. The unit does not work, no light and the fan does not work

1. Check the connection of power and main fuse.
2. Measure the mains voltage on the main connector.
3. Check the power on LED.

B. Not responding to DMX controller

1. DMX LED should be on. If not, check DMX connectors, cables to see if link properly.
2. If the DMX LED is on and no response to the channel, check the address settings and DMX polarity.
3. If you have intermittent DMX signal problems, check the pins on connectors or on PCB of the unit or the previous one.
4. Try to use another DMX controller.
5. Check if the DMX cables run near or run alongside to high voltage cables that may cause damage or interference to DMX interface circuit.

C. Some units don't respond to the easy controller

1. You may have a break in the DMX cabling. Check the LED for the response of the master/ slave mode signal.
2. Wrong DMX address in the unit. Set the proper address.

D. No response to the sound

1. Make sure the unit does not receive DMX signal.
2. Check microphone to see if it is good by tapping the microphone

E. One of the channels is not working well

1. The stepper motor might be damaged or the cable connected to the PCB is broken.
2. The motor's drive IC on the PCB might be out of condition

6. Fixture Cleaning

The cleaning of internal and external optical lenses and/or mirrors must be carried out periodically to optimize light output. Cleaning frequency depends on the environment in which the fixture operates: damp, smoky or particularly dirty surrounding can cause greater accumulation of dirt on the unit's optics.

- Clean with soft cloth using normal glass cleaning fluid.
- Always dry the parts carefully.
- Clean the external optics at least every 20 days. Clean the internal optics at least every 30/60 days.

EC Declaration of Conformity

We declare that our products (lighting equipments) comply with the following specification and bears CE mark in accordance with the provision of the Electromagnetic Compatibility (EMC) Directive 89/336/EEC.

EN55014-2: 1997 A1: 2001, EN61000-4-2: 1995; EN61000-4-3: 2002;
EN61000-4-4: 1995; EN61000-4-5: 1995, EN61000-4-6: 1996,
EN61000-4-11: 1994.

&

Harmonized Standard

EN60598-1: 2000+ALL: 2000+A12: 2002
Safety of household and similar electrical appliances
Part 1: General requirements

Innovation, Quality, Performance