

# LED Power Command

## TABLE OF CONTENTS

1. Safety Instructions
2. Features
3. Technical Specifications
4. Description of the fixture
5. Installation
  - 5-1 Installation Color Tube
  - 5-2 Installation Color Ball
  - 5-3 Installation Color inset
6. How to control the unit
  - 6-1 By Master/Slave operation
  - 6-2 DMX address setting by dipswitches
  - 6-3 By LED-RC controller
  - 6-4 By LED-CC controller
7. Fixture Cleaning

### PATTERNS SELECTION

NO.	DIPSWITCH	SOUND & AUTO MODE	LATCH MODE
1		Standard chase	White
2		Bright chase	Red
3		Mood chase	Orange
4		Spectrum random chase	Amber
5		Spectrum sequence chase	Yellow
6		Dynamic chase	Light Yellow
7		Chase Red-Cyan	Apple Green
8		Chase Green-Purple	Light Green
9		Chase Blue-Red	Green
10		Chase Yellow-Blue	Cyan
11		Chase Red-Green	Blue
12		Chase Yellow-Green	Deep Blue
13		Chase Cyan-Orange	Purple
14		Chase Green-Light Purple	Light Purple
15		Chase Red-Yellow	Magenta
16		Chase Gold Yellow-Blue	Pink

### POWER COMMANDER

• by Acme •

Power Pack controller for LEDs

## LED-PC100

#### MODE SELECTION

NO.	DIPSWITCH	MODE
1		SOUND
2		AUTO
3		FADE
4		LATCH

**WARNING**

• Rated max. Ambient temperature (TA) = 40°C  
 • Never open the housing without disconnecting the power supply first. Certain parts may still contain a voltage!  
 • All safety instructions and warnings relating to installation and use of this product must be observed. Electrical installation and service must be carried out by authorized and qualified technicians.

## USER MANNEL

Please read these instructions carefully before use

## 1. Safety Introductions



WARNING

Please read the instructions carefully which includes important information about the installation, operation and maintenance.

- Please keep this User Manual for future consultation. If you sell the fixture to another user, be sure that they also receive this instruction booklet.
- Unpack and check carefully there is no transportation damage before using the fixture.
- Before operating, ensure that the voltage and frequency of power supply match the power requirements of the fixture.
- It's important to ground the yellow/green conductor to earth in order to avoid electric shock.
- Disconnect main power before servicing and maintenance.
- Use safety chain when fixes this fixture. Don't handle the fixture by taking its head only, but always by taking its base.
- Maximum ambient temperature is  $T_a : 40^{\circ}\text{C}$ . Don't operate it where the temperature is higher than this.
- In the event of serious operating problem, stop using the fixture immediately. Never try to repair the fixture by yourself. Repairs carried out by unskilled people can lead to damage or malfunction. Please contact the nearest authorized technical assistance center. Always use the same type spare parts.
- Do not connect the device to any dimmer pack.
- Do not touch any wire during operation and there might be a hazard of electric shock.
- To prevent or reduce the risk of electrical shock or fire, do not expose the fixture to rain or moisture.
- The housing must be replaced if they are visibly damaged.
- Do not look directly at the LED light beam while the fixture is on.
- There are no user serviceable parts inside the fixture. Do not open the housing or attempt any repairs by yourself. In the unlikely event your fixture may require service, please contact your nearest dealer.

## 2. Features

- A professional, user friendly DMX 4channels controller
- Equipped with build-in pre-program and Master/Slave operation
- Comes with 16 spectrum mix colors, color fade, and 16 different chase patterns. Providing the richest changing colors for the show
- Speed adjustable for Auto chase and Fade chase
- Sound activated function is available

## 3. Technical Specifications

- Power supply
  - AC 120V~60Hz (US)
  - AC 230/240/250V 50/60Hz (EU)
- Power consumption: 100W
- Channels
  - Channel 1 = Red
  - Channel 2 = Green
  - Channel 3 = Blue
  - Channel 4 = Dimmer/Strobe
- Weight: 4.5kg
- Dimension: 218×140×88 (mm)

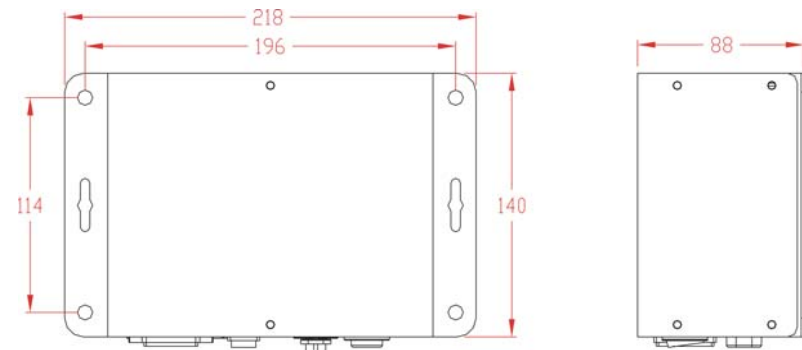

## 4. Description of the fixture

### 4.1 Functions

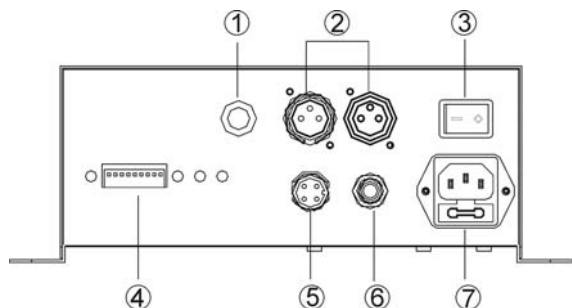

<b>1. Sound</b>	To receive audio signal for sound activated
<b>2. DMX Link</b>	Use 3-pin XLR plug cable to link the units together by DMX 512.
<b>3. Power Switch</b>	To switch on / off the power
<b>4. Dip switches</b>	Dipswitches 1~9 to setting the unit start DMX address, and dipswitch 10 to set the master/slave mode
<b>5. Single output</b>	For output DC 24V 100W max.
<b>6. INPUT</b>	For Analog switch input
<b>7. IEC socket</b>	Use to connect the power cable and replace fuse

## 5. Installation

**CAUTIONS:** Ensure that main power supply is off before installing or wire the LED fixture. You can use the controller to control to LED fixture, the LED controller total output power consumption is 100 watt, and each of output is 50 watt. Please refer to the following diagram for the LED fixture power consumption and link LED fixture to the controller.

Model	Color Ball	Color Inset	Color Tube 100	Color Tube 50	Color Tube 20
Power consumption	8W	3W	10W	5W	3W

### 5-1 Install Color Tube

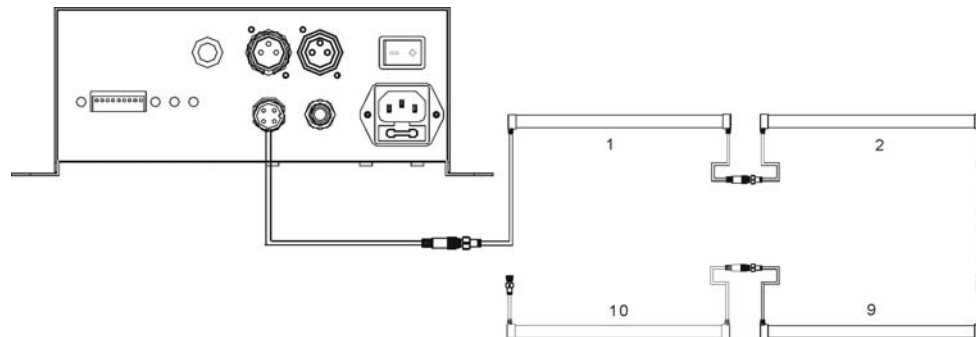

### 5-2 Install Color Ball

You have to use an adapter cable for connect the Color Ball, please make sure that the color codes inside the cables correspond to the colors of the fixture

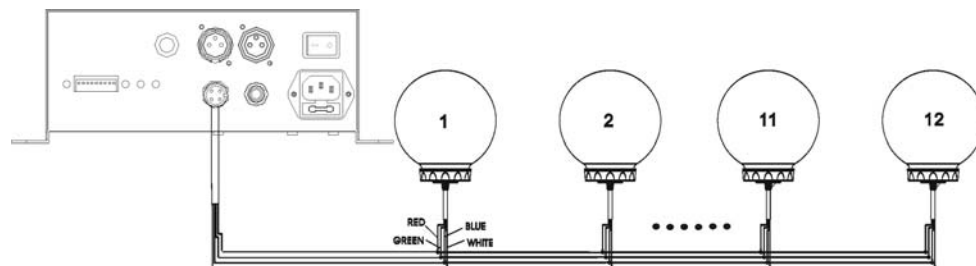

### 5-3 Install Color Inset

You have to use an adapter cable for connect the Color Inset, please make sure that the color codes inside the cables correspond to the colors of the fixture

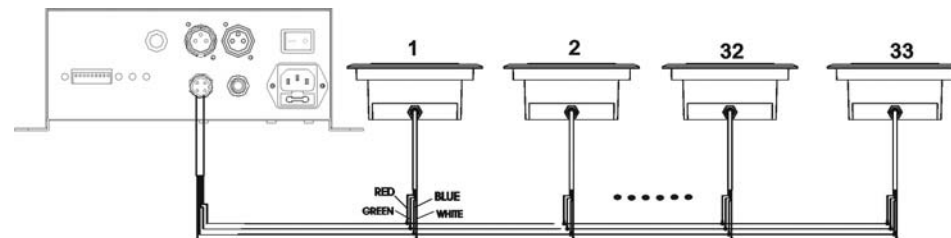

## 6. How to control the unit

You can operate the unit in four ways:

- A. Master/Slave operation
- B. Universal DMX controller
- C. LED-RC controller
- D. LED-CC controller

### 6-1 By Master/slave operation

By linking the units in master/slave connection, the first unit will control the other units to give an automatic activated synchronized light show. In this mode, the first unit (master) dipswitch 10 must be on. This function is good when you want an instant show. You will know which unit is the master because its DMX input jack will have nothing plugged into it. The other units (slaves) will have DMX cables plugged into the DMX input jacks (daisy chain). Please refer to the diagram on setting the dipswitches.

#### 6-1-1 Assign Dipswitch 10

Dipswitches setting	Function
	<b>DMX / Slave operation</b> Use the dipswitches 1~9 to set the DMX address from 0 to 511.
	<b>Master operation</b> Use the dipswitches 1~9 to set the mode, speed, patterns, latch color...etc functions.

#### 6-1-2 Assign Dipswitches 1 & 2, MODE (Sound/Auto/Fade/Latch)

Dipswitches setting	MODE
	SOUND
	AUTO
	FADE
	LATCH

#### 6-1-3 Assign Dipswitches 3,4 & 5, SPEED (from fast to slow)

Dipswitches setting	Auto/Fade Mode	
	Speed 1	Fast
	Speed 2	
	Speed 3	
	Speed 4	
	Speed 5	
	Speed 6	
	Speed 7	
	Speed 8	Slow

#### 6-1-4 Assign Dipswitches 6, 7, 8 & 9 CHASE & COLOR

NO	DIPSWITCH	SOUND & AUTO MODE	LATCH MODE
1		Standard chase	White
2		Bright chase	Red
3		Mood chase	Orange
4		Spectrum random chase	Amber
5		Spectrum sequence chase	Yellow
6		Dynamic chase	Light Yellow

7		Chase Red – Cyan	Apple Green
8		Chase Green – Purple	Light Green
9		Chase Blue – Red	Green
10		Chase Yellow – Blue	Cyan
11		Chase Red – Green	Blue
12		Chase Yellow – Green	Deep Blue
13		Chase Cyan – Orange	Purple
14		Chase Green - Light purple	Light Purple
15		Chase Red – Yellow	Magenta
16		Chase Gold Yellow - Blue	Pink

## 6-2 DMX address setting by dipswitches

1. Select the channels of DMX controller
2. Dipswitches

Dip	#1	#2	#3	#4	#5	#6	#7	#8	#9	#10
Value	1	2	4	8	16	32	64	128	256	M/S

- Examples:

Channel 01: dip / on : #1 (=1)

Channel 05: dip / on : #1, #3 (1+4=5)

Channel 09: dip / on : #1, #4 (1+8=9)

Channel 13: dip / on : #1, #3, #4 (1+4+8=13)

## 6-2-2 DMX 512 connection

The fixture is equipped with both 3-pin and 5-pin XLR sockets for DMX input and output. The sockets are wired in parallel.

Only use a shielded twisted-pair cable designed for 3-pin XLR-plugs and connectors in order to connect the controller with the fixture or one fixture with another.

**DMX-input**  
XLR mounting-plugs (rear view):



- 1 - Shield
- 2 - Signal (-)
- 3 - Signal (+)

**DMX - output**  
XLR mounting-sockets (rear view):



- 1 - Shield
- 2 - Signal (-)
- 3 - Signal (+)

At the last fixture, the DMX-cable has to be terminated with a terminator. Solder a 120Ω resistor between Signal (-) and Signal (+) into a 3-pin XLR-plug and plug it in the DMX-output of the last fixture.

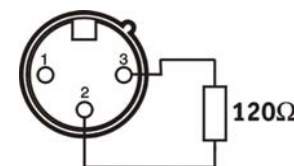

**6-2-1 DMX 512 configuration**

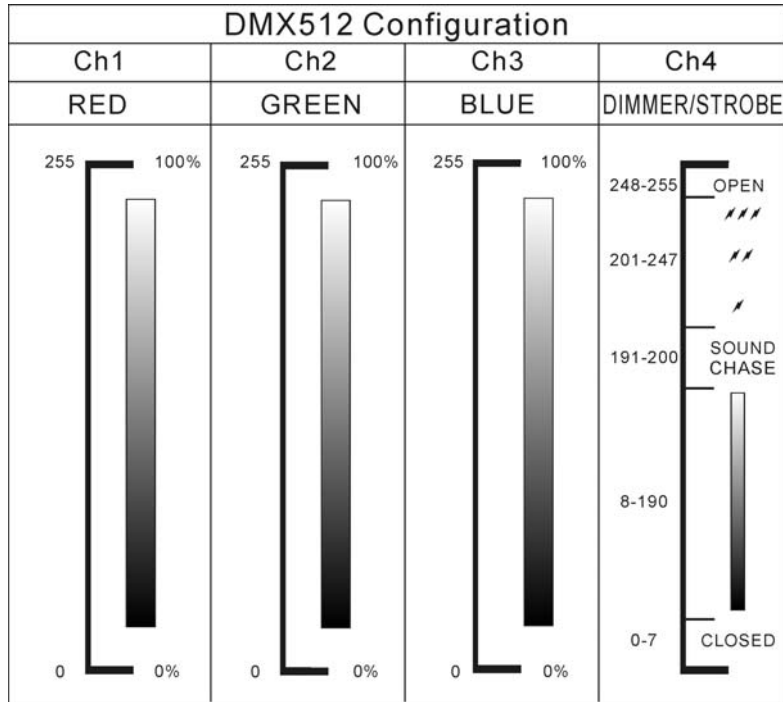

**6-3 By LED-RC controller**

You can use the LED-RC controller to controller the unit. Please refer to the diagram on as below. The unit Dipswitch 10 must be set off.

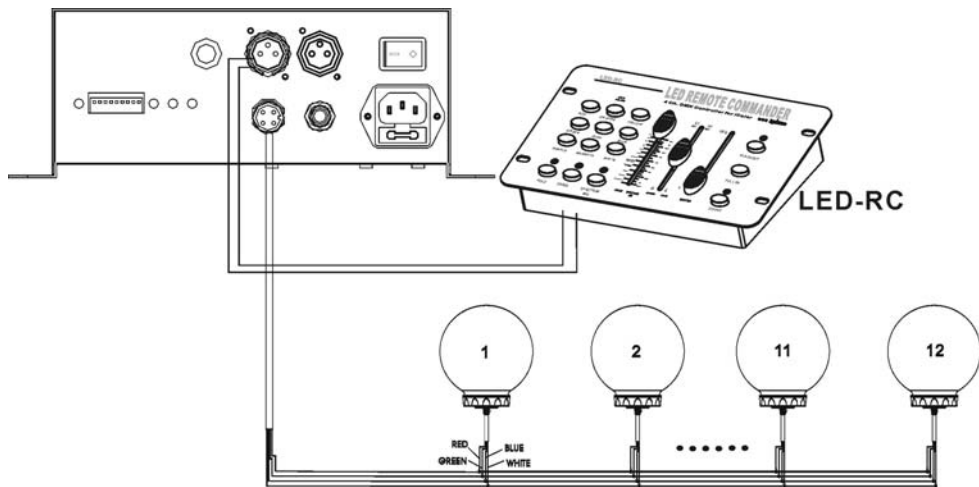

**6-4 By LED-CC controller**

You can use the LED-CC controller to controller the unit, Please refer to the diagram on as below. The unit Dipswitch 10 must be set off.

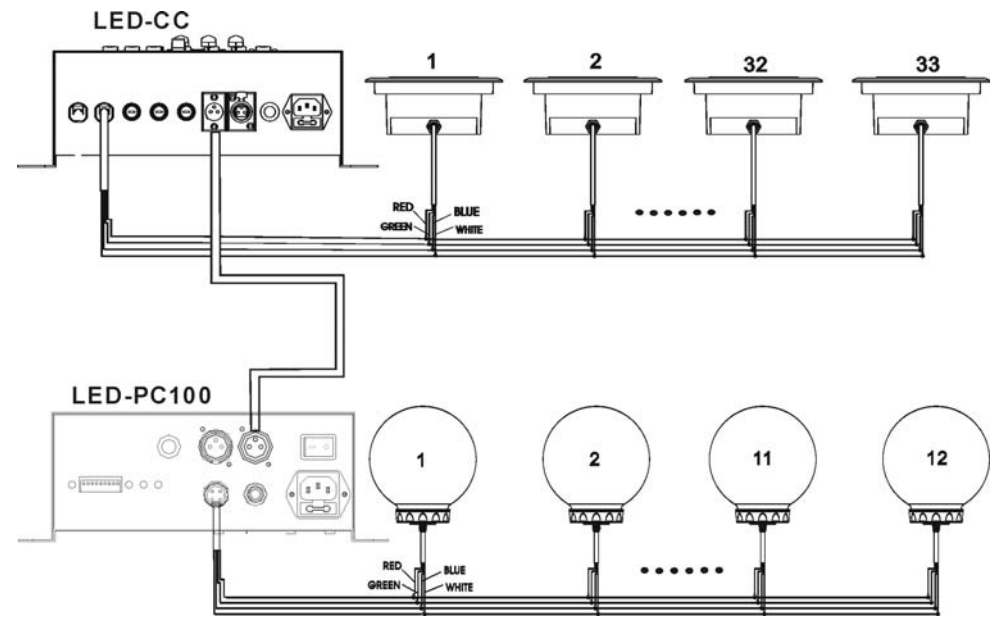

## 7. Fixture Cleaning

The cleaning of internal must be carried out periodically to optimize light output. Cleaning frequency depends on the environment in which the fixture operates: damp, smoky or particularly dirty surrounding can cause greater accumulation of dirt on the fixture's optics.

- Clean with soft cloth using normal glass cleaning fluid.
- Always dry the parts carefully.
- Clean the external optics at least every 20 days. Clean the internal optics at least every 30/60 days.

### **EC Declaration of Conformity**

We declare that our products (lighting equipments) comply with the following specification and bears CE mark in accordance with the provision of the Electromagnetic Compatibility (EMC) Directive 89/336/EEC.

EN55014-2: 1997 A1: 2001, EN61000-4-2: 1995; EN61000-4-3: 2002;  
EN61000-4-4: 1995; EN61000-4-5: 1995, EN61000-4-6: 1996,  
EN61000-4-11: 1994.

&

### **Harmonized Standard**

EN60598-1: 2000+ALL: 2000+A12: 2002  
Safety of household and similar electrical appliances  
Part 1 : General requirements

**Innovation, Quality, Performance**