

LEDJ

Stage Par Quad MKII **8W quad-colour LEDs (RGBW)**

User Manual



Order codes:

- Stage Par 12 Quad - LEDJ180 (Black Housing)
- Stage Par 12 Quad - LEDJ180P (Polished Housing)
- Stage Par 18 Quad - LEDJ181 (Black Housing)
- Stage Par 18 Quad - LEDJ181P (Polished Housing)

WARNING

FOR YOUR OWN SAFETY, PLEASE READ THIS USER MANUAL CAREFULLY BEFORE YOUR INITIAL START-UP!

- Before your initial start-up, please make sure that there is no damage caused during transportation.
- Should there be any damage, consult your dealer and do not use the equipment.
- To maintain the equipment in good working condition and to ensure safe operation, it is necessary for the user to follow the safety instructions and warning notes written in this manual.
- Please note that damages caused by user modifications to this equipment are not subject to warranty.



IMPORTANT:

The manufacturer will not accept liability for any resulting damages caused by the non-observance of this manual or any unauthorised modification to the equipment.

- Never let the power cable come into contact with other cables. Handle the power cable and all mains voltage connections with particular caution!
- Never remove warning or informative labels from the unit.
- Do not open the equipment and do not modify the unit.
- Do not connect this equipment to a dimmer pack.
- Do not switch the equipment on and off in short intervals, as this will reduce the system's life.
- Only use the equipment indoors.
- Do not expose to flammable sources, liquids or gases.
- Always disconnect the power from the mains when equipment is not in use or before cleaning! Only handle the power-cable by the plug. Never pull out the plug by pulling the power-cable.
- Make sure that the available mains supply voltage is between 100~240V AC, 50/60Hz.
- Make sure that the power cable is never crimped or damaged. Check the equipment and the power cable periodically.
- If the equipment is dropped or damaged, disconnect the mains power supply immediately and have a qualified engineer inspect the equipment before operating again.
- If the equipment has been exposed to drastic temperature fluctuation (e.g. after transportation), do not connect power or switch it on immediately. The arising condensation might damage the equipment. Leave the equipment switched off until it has reached room temperature.
- If your product fails to function correctly, stop use immediately. Pack the unit securely (preferably in the original packing material), and return it to your Pro Light dealer for service.
- Only use fuses of same type and rating.
- Repairs, servicing and power connection must only be carried out by a qualified technician. THIS UNIT CONTAINS NO USER SERVICEABLE PARTS.
- This lighting fixture is for professional use only - it is not designed for or suitable for household use. The product must be installed by a qualified technician in accordance with local territory regulations. The safety of the installation is the responsibility of the installer. The fixture presents risks of severe injury or death due to fire hazards, electric shock and falls.
- Warning! Risk Group 2 LED product according to EN 62471. Do not view the light output with optical instruments or any device that may concentrate the beam.
- WARRANTY: One year from date of purchase.

OPERATING DETERMINATIONS

If this equipment is operated in any other way, than those described in this manual, the product may suffer damage and the warranty becomes void. Incorrect operation may lead to danger e.g: short-circuit, burns and electric shocks etc.

Do not endanger your own safety and the safety of others!

Incorrect installation or use can cause serious damage to people and/or property.

Stage Par Quad MKII

The Stage Par Quad Series has 8W quad-colour LEDs punching out astonishing levels of colour ideal for uplighting in large venues, general stage wash and illumination. This fixture offers superior performance in a robust, yet lightweight housing, and features a simple to operate 4 push button menu that allows users to select several operation modes.

- Stage Par 12 Quad
 - 12 x 8W quad-colour LEDs (RGBW)
- Stage Par 18 Quad
 - 18 x 8W quad-colour LEDs (RGBW)
- Beam angle: 40°
- 2kHz refresh rate
- DMX channels: 4 or 8 selectable
- Static colour, colour change, fade, auto, sound active and master/slave modes
- 0 - 100% dimming with variable strobe
- Bracket allows for multiple rigging or floor standing applications
- 4 push button menu with LED display
- Captive power connection
- 3-Pin XLR input/output
- Fan cooled



Stage Par 12 Quad

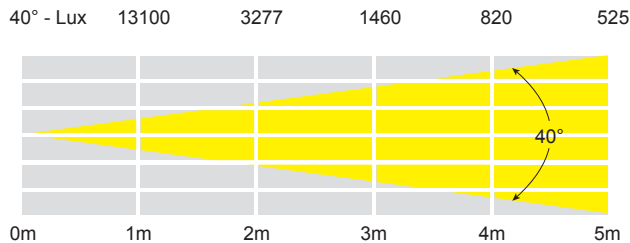

Stage Par 18 Quad

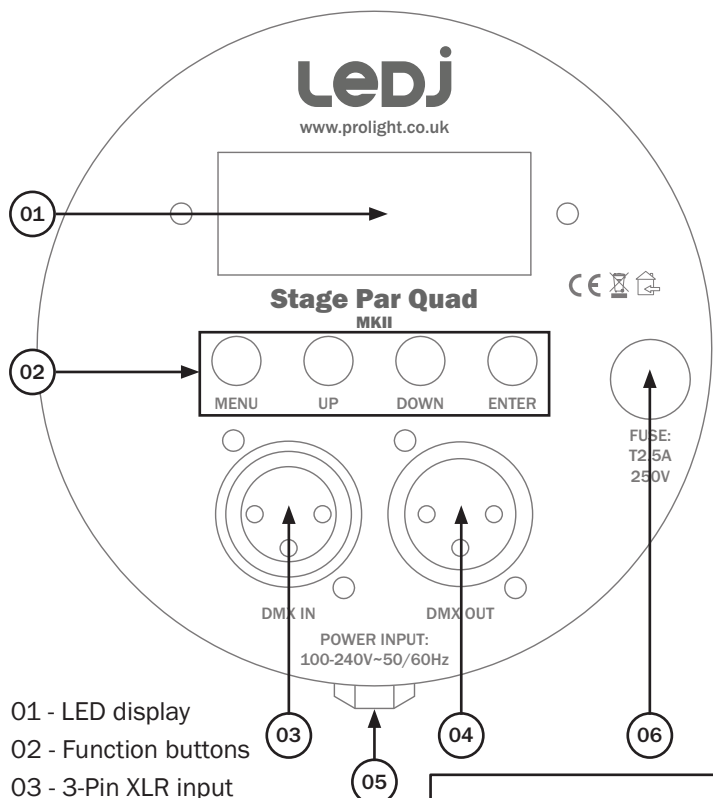
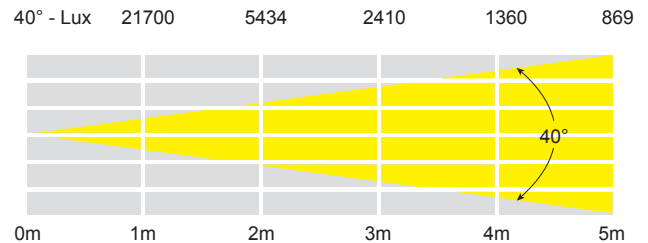

- 01 - LED display
- 02 - Function buttons
- 03 - 3-Pin XLR input
- 04 - 3-Pin XLR output
- 05 - Captive power connection
- 06 - Fuse T2.5A 250V

**In the box: 1 x fixture,
1 x power cable
& 1 x user manual**

Specifications	Stage Par Quad MKII
Power consumption	Stage Par 12 Quad - 105W Stage Par 18 Quad - 160W
Power supply	100~240V, 50/60Hz
Fuse	T2.5A 250V
Dimensions	345 x 275 x 220mm
Weight	3.1kg
Order codes	Stage Par 12 Quad - LEDJ180 (Black housing) Stage Par 12 Quad - LEDJ180P (Polished housing) Stage Par 18 Quad - LEDJ181 (Black housing) Stage Par 18 Quad - LEDJ181P (Polished housing)

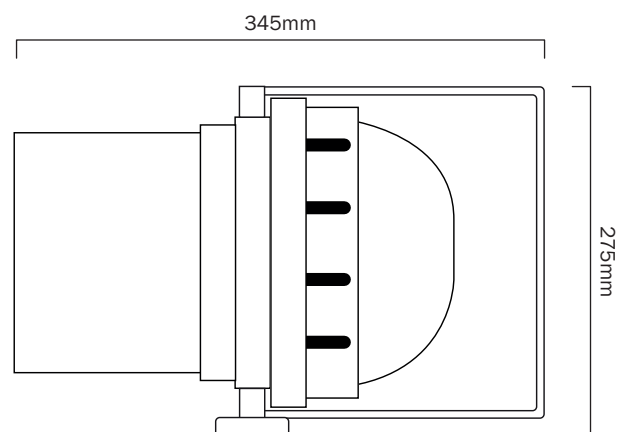

DMX mode:

To select the DMX address, press the “MENU” button on the rear of the unit to show *d001* on the LED display. Now press the “ENTER” button and use the “UP” and “DOWN” buttons to select the DMX address between 000-512.

To exit out of any of the above options, press the “MENU” button.

DMX channel mode:

Operating in a DMX control mode environment gives the user the greatest flexibility when it comes to customising or creating a show. In this mode you will be able to control each individual trait of the fixture and each fixture independently. To access the DMX channel mode, press the “MENU” button on the rear of the unit to show *-4CH* or *-8CH* on the LED display. Now press the “ENTER” button and use the “UP” and “DOWN” buttons to select between 4 and 8 channel.

To exit out of any of the above options, press the “MENU” button.

4 channel mode:

Channel	Value	Function
1	000-255	Red (0-100%)
2	000-255	Green (0-100%)
3	000-255	Blue (0-100%)
4	000-255	White (0-100%)

8 channel mode:

Channel	Value	Function
1	000-255	Master dimmer (0-100%)
2	000-255	Strobe (slow-fast)
3	000-049	Manual DMX
	050-099	Colour change
	100-149	Colour fade
	150-199	Colour fade in/out
	200-255	Sound active
4	000-255	Chase/fade speed (slow to fast)
5	000-255	Red (0-100%)
6	000-255	Green (0-100%)
7	000-255	Blue (0-100%)
8	000-255	White (0-100%)

Colour, auto, sound and master/slave modes:

Please note: To link the units for use in any of the colour, sound or master/slave modes, please set the unit(s) into 4 channel DMX mode first.

Menu system

Static colour mode	<i>r.000~r.255 R</i> <i>g.000~g.255 G</i> <i>b.000~b.255 B</i> <i>w.000~w.255 W</i>
Colour change mode	<i>CC00~CC99</i>
Colour fade mode	<i>CP00~CP99</i>
Auto mode	<i>dE00~dE99</i>
Sound active mode	<i>bEbE</i>
DMX mode	4CH, 8CH
Address setting	<i>d001~d512</i>

Colour change mode:

To access colour change mode press “MENU” until the display shows $CC - -$ on the LED display. Press “ENTER” to confirm the setting. Use the “UP” and “DOWN” buttons to adjust the speed between $CC00 \sim CC99$. Press the “ENTER” button to confirm the setting.

To exit out of any of the above options, press the “MENU” button.

Colour fade mode:

To access colour fade mode press “MENU” until the display shows $CP - -$ on the LED display. Press “ENTER” to confirm the setting. Use the “UP” and “DOWN” buttons to adjust the speed between $CP00 \sim CP99$. Press the “ENTER” button to confirm the setting.

To exit out of any of the above options, press the “MENU” button.

Auto mode:

To access auto mode press “MENU” until the display shows $DE - -$ on the LED display. Press “ENTER” to confirm the setting. Use the “UP” and “DOWN” buttons to adjust the speed between $DE00 \sim DE99$. Press the “ENTER” button to confirm the setting.

To exit out of any of the above options, press the “MENU” button.

Static colour mode:

To access the static colour mode press “MENU” until $r.225$ shows on the LED display. Now use the “UP” and “DOWN” buttons to select the brightness between $r.000 \sim r.255$. Press the “ENTER” button and repeat for green (\bar{G}), blue (\bar{b}) and white (\bar{w}).

Value: 000 - 255 (000 = low brightness, 255 = high brightness)

To exit out of any of the above options, press the “MENU” button.

Master/slave mode:

To set the master unit, press the “MENU” button on the rear of the master unit to select your desired program (sound active, auto, static colour or colour fade).

To set the other units in slave mode, press the “MENU” button on the rear of the unit to show $d00 |$ on the LED display and press the “ENTER” button to confirm the setting. The units will now run in sequence with the master unit.

To exit out of any of the above options, press the “MENU” button.

Please ensure that all slave units are set to the same DMX channel mode as the master unit.

Sound active mode:

To access the sound active mode, press the “MODE” button on the rear of the unit to show $bEbE$ on the LED display. The unit will now respond to sound.

To exit out of any of the above options, press the “MODE” button.

Setting the DMX address:

The DMX mode enables the use of a universal DMX controller. Each fixture requires a “start address” from 1- 512. A fixture requiring one or more channels for control begins to read the data on the channel indicated by the start address. For example, a fixture that occupies or uses 7 channels of DMX and was addressed to start on DMX channel 100, would read data from channels: 100,101,102,103,104,105 and 106. Choose a start address so that the channels used do not overlap. E.g. the next unit in the chain starts at 107.

DMX 512:

DMX (Digital Multiplex) is a universal protocol used as a form of communication between intelligent fixtures and controllers. A DMX controller sends DMX data instructions from the controller to the fixture. DMX data is sent as serial data that travels from fixture to fixture via the DATA “IN” and DATA “OUT” XLR terminals located on all DMX fixtures (most controllers only have a data “out” terminal).

DMX linking:

DMX is a language allowing all makes and models of different manufactures to be linked together and operate from a single controller, as long as all fixtures and the controller are DMX compliant. To ensure proper DMX data transmission, when using several DMX fixtures try to use the shortest cable path possible. The order in which fixtures are connected in a DMX line does not influence the DMX addressing. For example; a fixture assigned to a DMX address of 1 may be placed anywhere in a DMX line, at the beginning, at the end, or anywhere in the middle. When a fixture is assigned a DMX address of 1, the DMX controller knows to send DATA assigned to address 1 to that unit, no matter where it is located in the DMX chain.

DATA cable (DMX cable) requirements (for DMX operation):

This fixture can be controlled via DMX-512 protocol. The DMX address is set on the back of the unit. Your unit and your DMX controller require a standard 3-pin XLR connector for data input/output, see image below.



Further DMX cables can be purchased from all good sound and lighting suppliers or Pro Light Concepts dealers.

Please quote:

CABL10 – 2m

CABL11 – 5m

CABL12 – 10m

Also remember that DMX cable must be daisy chained and cannot be split.

Notice:

Be sure to follow the diagrams below when making your own cables. Do not connect the cables shield conductor to the ground lug or allow the shield conductor to come in contact with the XLRs outer casing. Grounding the shield could cause a short circuit and erratic behaviour.

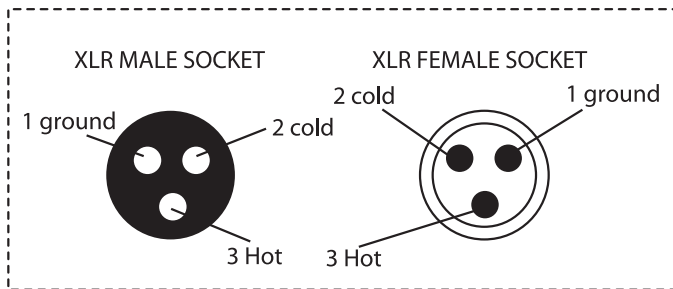
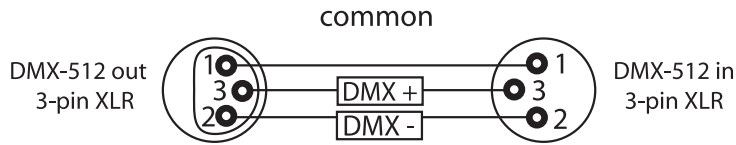

XLR Pin Configuration
Pin 1 = Ground
Pin 2 = Negative
Pin 3 = Postive

Special note:

Line termination:

When longer runs of cable are used, you may need to use a terminator on the last unit to avoid erratic behaviour.

Using a cable terminator will decrease the possibilities of erratic behaviour.

(3-pin - Order ref: CABL90, 5-pin - Order ref: CABL89)

Termination reduces signal transmission problems and interference. It is always advisable to connect a DMX terminal, (resistance 120 Ohm 1/4 W) between pin 2 (DMX-) and pin 3 (DMX+) of the last fixture.

5-pin XLR DMX connectors:

Some manufactures use 5-pin XLR connectors for data transmission in place of 3-pin. 5-pin XLR fixtures may be implemented in a 3-pin XLR DMX line. When inserting standard 5-pin XLR connectors in to a 3-pin line a cable adaptor must be used. The diagram below details the correct cable conversion.

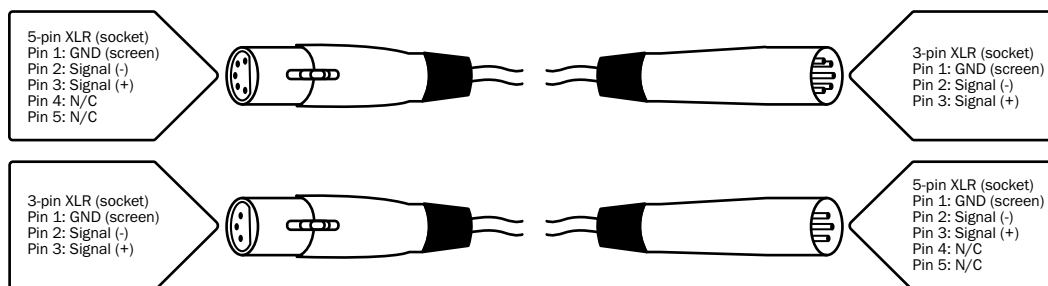



Correct Disposal of this Product (Waste Electrical & Electronic Equipment)

**(Applicable in the European Union and other European countries
with separate collection systems)**

This marking shown on the product or its literature, indicates that it should not be disposed of with other household wastes at the end of its working life. To prevent possible harm to the environment or human health from uncontrolled waste disposal, please separate this from other types of wastes and recycle it responsibly to promote the sustainable reuse of material resources.

Household users should contact either the retailer where they purchased this product, or their local government office, for details of where and how they can take this item for environmentally safe recycling.

Business users should contact their supplier and check the terms and conditions of the purchase contract. This product should not be mixed with other commercial wastes for disposal.

