

Zenith

LSP Series Loudspeaker Processors User Manual



Order codes:
PROC06 - LSP204
PROC07 - LSP408

WARNING**FOR YOUR OWN SAFETY, PLEASE READ THIS USER MANUAL CAREFULLY BEFORE YOUR INITIAL START-UP!**

- Immediately upon receiving this product, carefully unpack the carton and check the contents to ensure that all the parts are present.
- Before initial start-up, please make sure that there is no damage caused during transportation.
- Should there be any damage, consult your dealer and do not use the equipment.
- Retain the carton and all packaging materials.
- In the event that the equipment must be returned to the supplier, it is important that the equipment is returned in the original carton and packaging.
- To maintain the equipment in good working condition and to ensure safe operation, it is necessary for the user to follow the safety instructions and warning notes written in this manual.
- Please note that damages caused by user modifications to this equipment are not subject to warranty.

**IMPORTANT:**

The manufacturer will not accept liability for any resulting damages caused by the non-observance of this manual or any unauthorised modification to the equipment.

- Never let the power cable come into contact with other cables. Handle the power cable and all mains voltage connections with caution!
- Never remove warning or informative labels from the equipment.
- Do not open or modify the equipment.
- Do not connect this equipment to a dimmer-pack.
- Do not switch the equipment on and off in short intervals, as this will reduce the system's life.
- Only use the equipment indoors.
- Do not expose to flammable sources, liquids or gases.
- Always disconnect the power from the mains when equipment is not in use or before cleaning! Only handle the power cable by the plug. Never pull out the plug by pulling the power cable.
- Make sure that the available voltage is between 90-250V, 50/60Hz AC.
- Make sure that the power cable is never crimped or damaged. Check the equipment and the power cable periodically.
- If the equipment is dropped or damaged, disconnect the mains power supply immediately. Have a qualified engineer inspect the equipment before operating again.
- If the equipment has been exposed to drastic temperature fluctuation (e.g. after transportation), do not switch it on immediately. The arising condensation might damage the equipment. Leave the equipment switched off until it has reached room temperature.
- If the product fails to function correctly, discontinue use immediately. Pack securely (preferably in the original packing material), and return to your dealer for service.
- Only use fuses of same type and rating.
- Repairs, servicing and power connection must only be carried out by a qualified technician. THIS UNIT CONTAINS NO USER SERVICEABLE PARTS.
- WARRANTY: One year from date of purchase.

OPERATING DETERMINATIONS

If this equipment is operated in any other way, than those described in this manual, the product may suffer damage and the warranty becomes void. Incorrect operation may lead to danger e.g: short-circuit, burns and electric shocks etc.

In case of malfunction this unit should be returned for service or inspection.

Do not endanger your own safety and the safety of others!

Incorrect installation or use can cause serious damage to people and/or property.

Front Panel

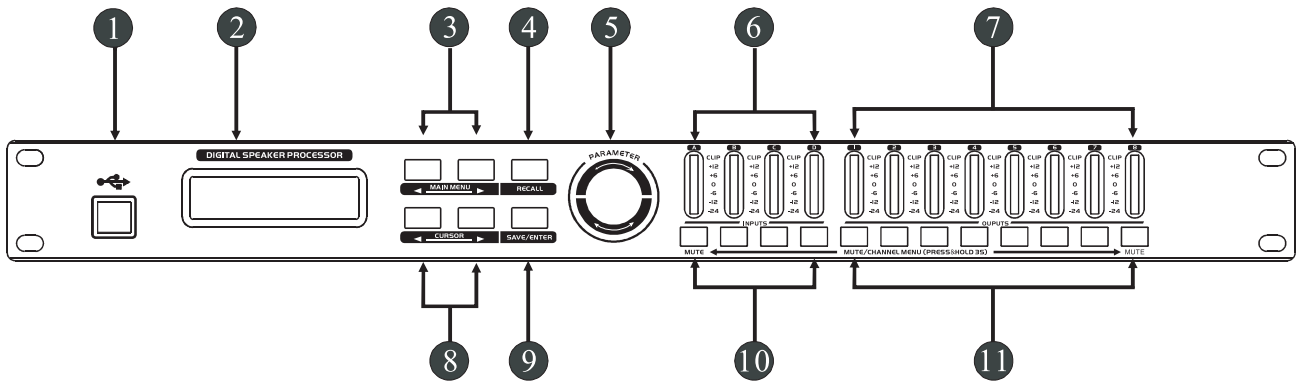

- | | | | |
|---|-------------------------------------|----|---|
| 1 | USB Interface | 7 | 7-Segment LED Output Level Indicator |
| 2 | 132 x 32 Dot-Matrix LCD Display | 8 | CURSOR Navigation Buttons |
| 3 | MAIN MENU Navigation Buttons | 9 | SAVE / ENTER Buttons |
| 4 | RECALL Button | 10 | Input MENU / MUTE Buttons and the Related LEDs |
| 5 | PARAMETER Adjustment Rotary Encoder | 11 | Output MENU / MUTE Buttons and the Related LEDs |
| 6 | 7-Segment LED Input Level Indicator | | |

Rear Panel

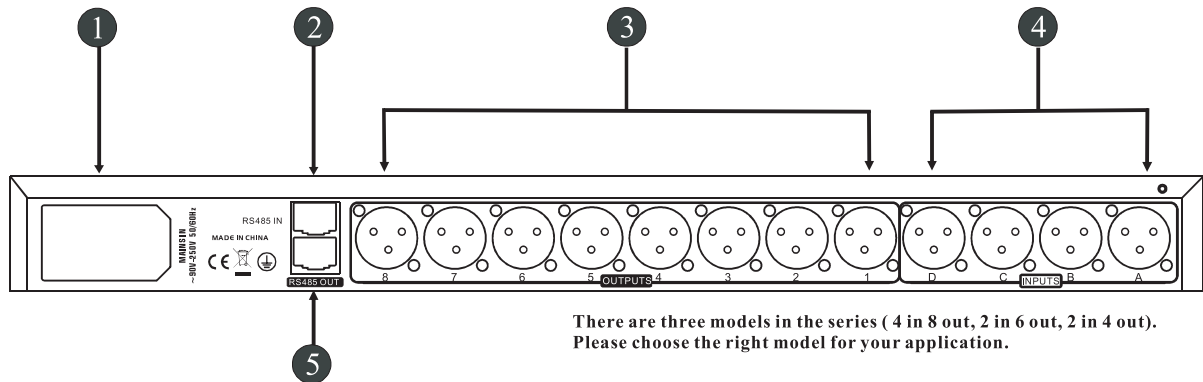

- | | | | |
|---|----------------------------------|---|-----------------------------|
| 1 | Mains Input & Fuse Box | 4 | 4 / 2 Channel Input Sockets |
| 2 | RS485 Input | 5 | RS485 Output |
| 3 | 8 / 6 / 4 Channel Output Sockets | | |

System Connection Diagram

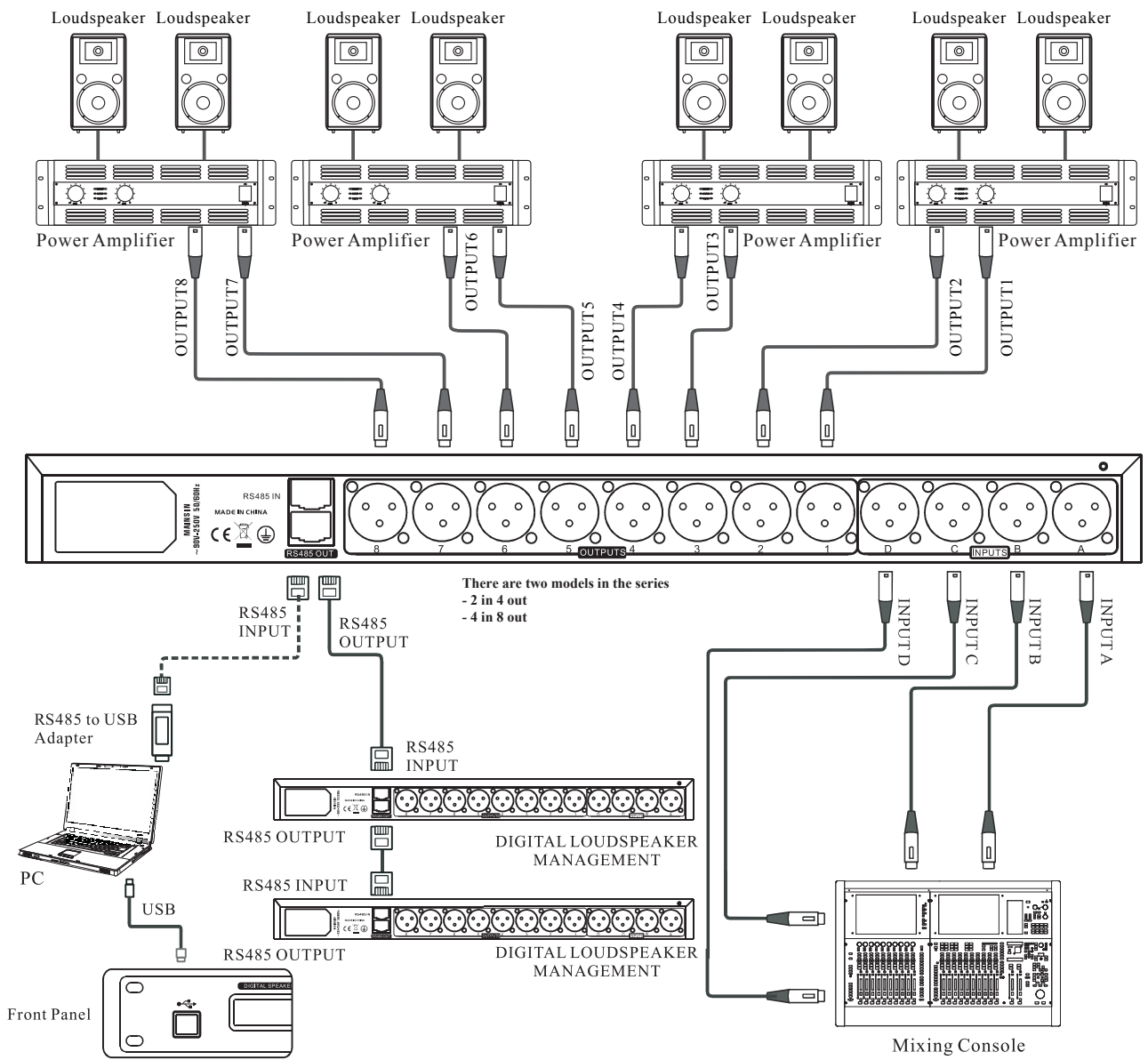

Features

- LSP204 - 2 XLR inputs, 4 XLR out LSP408 - 4 XLR inputs, 8 XLR out
- 24-bit DSP with high performance AD/DA converters
- 48kHz sampling rate
- Input/output level control with -40dB to +12dB range in 0.1dB increments
- 7 band PEQ (parametric EQ) for each input and each output - Each EQ features parametric, low shelf 6dB, low shelf 12dB, high shelf 6dB and high shelf 12dB
- PEQ frequency range: 19.7Hz thru 21.9kHz, gain range -30dB to +15dB, bandwidth: 0.017 to 4.750 octave
- Output high pass and low pass filter, each filter has multiple slopes and types
- Filter slopes: 12dB/Oct, 24dB/Oct, 36dB/Oct, 48dB/Oct
- Filter types: Butterworth, Bessel or Linkwitz-Riley
- Up to 1 second of delay for each input and output, switchable and selectable
- Compressor for each input and output with adjustable threshold, ratio, attack-time, release-time and knee type
- Phase reverse for each input and output
- Copy function allows settings to be copied between channels

Operation

1 Power on

- 1.1 Plug in the power cable, turn on the power switch on the panel, then the LCD shows the brand, model and version.



- 1.2 When the loading is completed, the LCD shows the current program number, name and the processor ID.



2 Front Panel Buttons and the Function

2.1 MUTE

2.1.1 Press the MUTE

Function: Switch between the state of mute or not for each channel.

Operation: Press MUTE for less than 2 seconds and then release it. The status of mute or not is switchable for each channel.

2.1.2 Press and Hold the MUTE

Function: Enter in the parameter setting menu of some channel.

Operation: Press and hold the MUTE (about 3 seconds) on the selected channel till the settings page displayed on LCD. Then release the button.

2.2 PARAMETER Encoder

2.2.1 Rotate the Encoder

Function: Change the value or options of parameters. Rotate clockwise to increase the value. Rotate anticlockwise to decrease the value.

Operation: Rotate the encoder clockwise or anticlockwise.

2.2.2 Push the Menu Lock via Encoder

Function: Lock and unlock. Push and hold the encoder to lock all buttons and encoder, push again to unlock.

Operation: Push the encoder and release it.

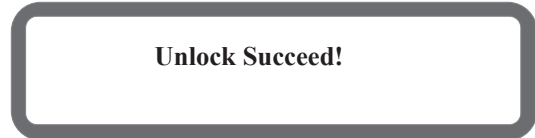
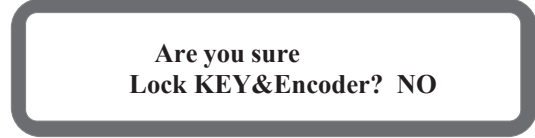
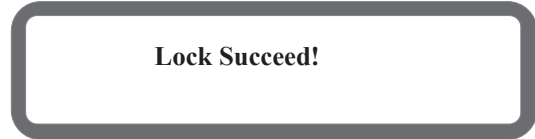
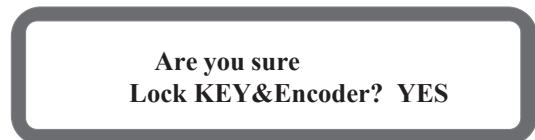

2.3 MAIN MENU ◀ and ▶

Function: A) Switch to different settings page of the same channel at the channel parameter set menu.

B) Switch to different menus at program management and configuration setting.

Operation: Press it and then release it.

2.4 CURSOR ◀ and ▶

Function: Move the Cursor position to change the parameter at the Cursor.

Operation: Press the button and then release.

2.5 RECALL

Function: A) Enter into user program menu.

B) Return to the root menu.

Operation: Press the button and then release.

2.6 SAVE / ENTER

Function: A) Enter in the menu of saving user program.

B) Enter in the next submenu or confirm the function.

Operation: Press the button and then release.

3 Front Panel Menu Operation

3.1 Common Operation for Channel Parameter Set

- ✱ Press and hold the MUTE (about 3 seconds) of the selected channel and enter into the parameter settings menu of this channel.
- ✱ Press button MAIN MENU ◀ or ▶ to switch between different pages in this channel.
- ✱ Press CURSOR ◀ or ▶ to move cursor position, and then rotate the Rotary Encoder to adjust the value.

3.2 Various Operations for Channel Parameter Set

3.2.1 Input / Output Mute Set

- ✱ Press MUTE button to your designated channel for less than 2 seconds and release it. Mute status will be reversed when press the button each time.
- ✱ The LED in the MUTE button will bright in red when the channel is mute, vice versa.

3.2.2 Input / Output Gain Set

- ✱ Press MAIN MENU ◀ or ▶ to switch to GAIN settings page.
- ✱ Rotate the Rotary Encoder to change the value.
- ✱ Can also press CURSOR ◀ or ▶ to change the cursor's position below the value, in order to switch to other step, such as 0.1dB or 1dB.



3.2.3 Input / Output Delay Set

- Press MAIN MENU ◀ or ▶ to switch to DELAY settings page.
- Rotate the Rotary Encoder to change the parameters with the step of 0.021ms.
- Can also press CURSOR ◀ or ▶ to change the cursor's position below the value, in order to switch to other step, such as 105ms, 10.5ms, 1.05ms, 0.105ms, 0.021ms, or adjust the Delay switch.

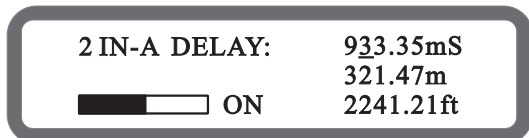

3.2.4 Input / Output PEQ Set

- Press MAIN MENU ◀ or ▶ to switch to PEQ settings page.
- Press CURSOR ◀ or ▶ to move the cursor position.
- Rotate the Rotary Encoder to adjust the parameters at the cursor position.
- The Frequency, Gain of PEQ can be adjusted coarse or fine at the cursor position.

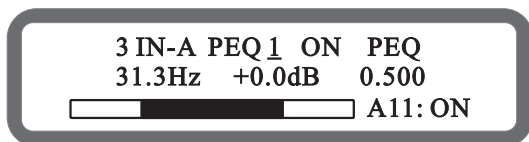

3.2.5 Input / Output Compressor Set

- Press MAIN MENU ◀ or ▶ to switch to COMPRESS settings page.
- Press CURSOR ◀ or ▶ to move the cursor position.
- Rotate the Rotary Encoder to adjust the parameters at the cursor position.



3.2.6 Input / Output LINK Set

- Press MAIN MENU ◀ or ▶ to switch to LINK settings page.
- Press CURSOR ◀ or ▶ to move the Cursor position.
- Rotate the Rotary Encoder to adjust the parameters at the cursor position.
- Press SAVE/ENTER into the link confirmation dialogs.
- Default is NO, no link setting. Switch between YES and NO with the Rotary Encoder.
- Press SAVE/ENTER again to confirm the link setting.

Note: If Yes is chosen as link set, the source channel parameters will be copied to the target channel.



3.2.7 Data COPY of Input / Output Channel

- Press MAIN MENU ◀ or ▶ to switch to COPY settings page.
- Rotate the Rotary Encoder to change the target channel.
- Press SAVE / ENTER into COPY confirmation dialogs.
- Default is NO, no copy operation. Switch between YES and NO with the Rotary Encoder.
- Press SAVE / ENTER again to confirm the copy operation.

Note: At the COPY set, the source channel parameters will be copied to the target channel.

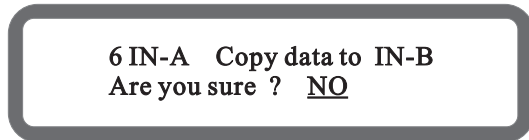
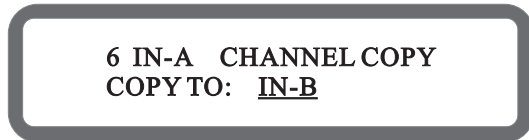

3.2.8 Output HIGH/LOW PASS FILTER Set

- Press MAIN MENU ◀ or ▶ to switch to HIGH/LOW - PASS Filter settings page.
- Press CURSOR ◀ or ▶ to move the cursor.
- Rotate the Rotary Encoder to adjust the parameters at the cursor position.
- The frequency of HIGH/LOW - PASS Filter can be adjusted coarse or fine at the cursor position.

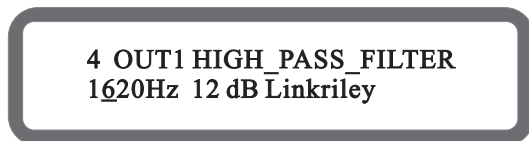

3.2.9 Output PHASE Set

- Press MAIN MENU ◀ or ▶ to switch to PHASE settings page.
- Rotate the Rotary Encoder to change PHASE parameter.

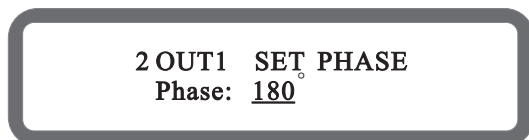

3.2.10 SOURCE Set

- Press MAIN MENU ◀ or ▶ to switch to SOURCE settings page.
- Rotate the Rotary Encoder to change SOURCE parameter.

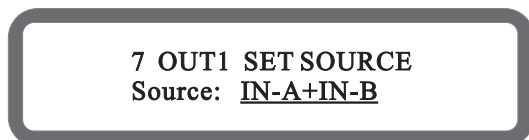

3.3 Program Management and Configuration Setting

3.3.1 Recall an User Program

- Continuously press RECALL till the menu (LOAD USER PROGRAM) as the below picture displays.
- Rotate the Rotary Encoder to change the program number.
- Press SAVE/ENTER to finish the recall operation.

**3 LOAD USER PROGRAM: 1
MEMORY**

**Loading User Program
Please Wait.**

3.3.2 Store an User Program

- Press RECALL to return to the root menu if entered channel menu, or skip this step.
- Then press SAVE / ENTER till the menu (STORE USER PROGRAM) as the below picture displays.
- Press CURSOR ◀ or ▶ to move the cursor.
- Rotate the Rotary Encoder to change program number and program name.
- Press SAVE/ENTER to finish the storing operation.

**4 STORE USER PROGRAM: 1
MEMORY**

**4 STORE USER PROGRAM: 1
Are you sure ? NO**

**Storing User Program
Please Wait.**

3.3.3 Recall a Preset Program

- Press RECALL to return to the root menu if entered channel menu, or skip this step.
- Then press MAIN MENU ◀ or ▶ till the menu (LOAD PRESET PROGRAM) as the below picture displays.
- Rotate the Rotary Encoder to change the preset program number.
- Press SAVE / ENTER to finish the operation of recall preset.

**2 LOAD PRESET PROGRAM: 1
4x2Way Crossover**

**Loading Preset
Please Wait.**

3.3.4 Erase an User Program

- Press RECALL to return to the root menu if entered channel menu, or skip this step.
- Then press MAIN MENU ◀ or ▶ till the menu(ERASE USER PROGRAM) as the follow picture displays.
- Rotate the Rotary Encoder to change the preset program number.
- Press SAVE / ENTER to finish the operation of erasing user program.

**5 ERASE USER PROGRAM: 1
MEMORY**

**5 ERASE USER PROGRAM: 1
Are you sure ? NO**

**Erasing User Program
Please Wait.**

3.3.5 Device Address Setting

- Press RECALL to return to the root menu if entered channel menu, or skip this step.
- Then press MAIN MENU ◀ or ▶ till the menu(SET DEVICE ADDRESS) as the below picture displays.
- Rotate the Rotary Encoder to change the device address.
- Press SAVE / ENTER to finish the operation of device address setting.

**6 SET DEVICE ADDRESS
DEVICE ID: 1**

**Setting Device address
Please Wait.**

3.3.6 Lock / Unlock the Device

- Press RECALL to return to the root menu if entered channel menu, or skip this step.
- Then press MAIN MENU ◀ or ▶ till the menu (LOCK DEVICE) as the below picture displays.
- Press CURSOR ◀ or ▶ to move cursor.
- Rotate the Rotary Encoder to change the lock type and password.
- Press SAVE/ENTER to finish the lock operation.

**7 LOCK DEVICE
TYPE: Change & View
Password: 12345678**

8 LOCK DEVICE
TYPE: Change & View
Are you sure ? NO

Lock succeed

3.3.7 Lock / Unlock the Buttons & Encoder

- Push the Rotary Encoder to lock all Buttons and Rotary Encoder.
- Push Rotary Encoder again to unlock.

3.4 Channel's Parameter Range

Items	Range	Steps
Gain	-40dB ~ +12dB	1dB/0.1dB
Delay	ON/OFF, 0ms~1000.00ms	105/10.5/1.05/ 0.105/0.021(ms)
PEQ Bands	1 ~ 7	-
PEQ Bypass	ON/OFF	-
PEQ Type	PEQ, Low-Shelf 6dB, Low-Shelf 12dB, High-Shelf 6dB, High-Shelf 12dB, Phase-Shifter	-
PEQ Frequency	19.7Hz ~ 21.9kHz	Coarse/Fine
PEQ Gain	-30dB ~ +15dB	1dB/0.1dB
Compressor's Knee	Off/Hard knee/Soft knee 1/Soft knee 2/Soft knee 3/Soft knee 4/Soft knee 5	-
Compressor's Threshold	-20dB ~ +20dB	0.5dB
Compressor's Ratio	1.2, 1.5, 2, 3, 4, 6, 10, 20, 40, 128	-
Compressor's Attack-Time	0 ms ~100ms	1ms
Compressor's Release-Time	50 ms ~1000ms	50ms
High/Low-Pass Filter Frequency	19.7Hz~21.9kHz	Coarse/Fine
High/Low-Pass Filter Solpe	Flat, 12dB Bessel, 12dB Butterworth, 12dB Linkwitz-Riley, 24dB Bessel, 24dB Butterworth, 24dB Linkwitz-Riley, 36dB Bessel, 36dB Butterworth, 36dB Linkwitz-Riley, 48dB Bessel, 48dB Butterworth, 48dB Linkwitz-Riley	-
Phase Inverter	0°/180°	-

3.5 Parameter Range of Program Management and Configuration Setting

Items	Range	Steps
Load User Program	1 ~ 30	1
Store User Program	Program Number: 1 ~ 30 Program Name: ASCII Charater	1
Load Preset Program	1 ~ 10	1
Erase User Program	1 ~ 30	1
Set Device Address	1 ~ 32	1
Lock / Unlock Device	Type: Change, Change&View, Change & Mute, Password: ASCII Charater	-

4 Software Installation

Puts the CD of accessories to the CD-ROM of computer, open the file SETUP.EXE in the CD to launch the software. When loading menu is showed, click the NEXT step by step till the installation is completed.

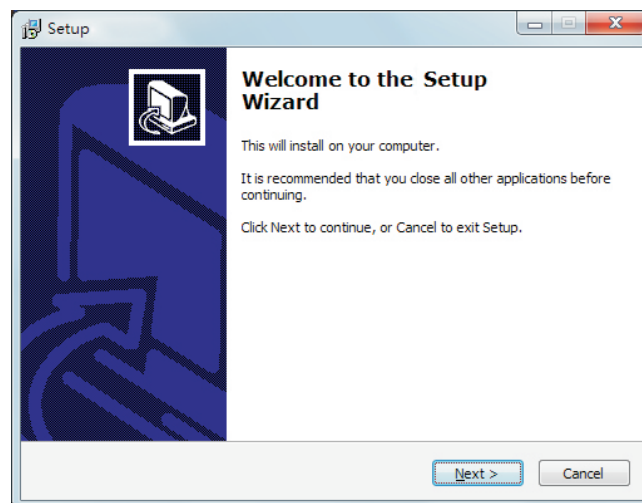

5 PC Online Operation

5.1 One Processor Communication Link with PC: Multi-types as USB, RS485 etc.

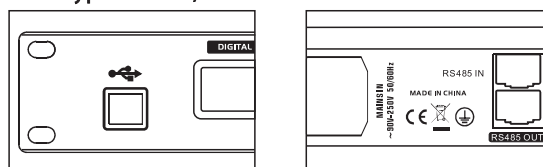

Note: The ID of User Interface should be set to the same with the processor in order to the succeed online.

5.2 Multi Processors Communication Link with PC: RS485

- Use USB-RS485 convertor and Cat 5e cable to connect PC with RS485-IN interface of the first device.
- Use Cat 5e cable to connect RS485-OUT interface of the first device with RS485-IN interface of the second device.
- Use Cat 5e cable to connect RS485-OUT interface of the second device with RS485-IN interface of the third device.
- As step 3, use Cat 5e cable to connect multi devices. One PC can be connected with three models of device (4 in 8 out, 2 in 6 out, 2 in 4 out) . The maximum number of connections are 32 processors.

Note: 1 For the same model processor, each device ID should be set differently.

2 USB-RS485 convertor is an optional accessory.

Install the driver and software that is on the included CD-ROM. Connect the Processor to a computer via the USB cable. Power ON the processor and open the installed software on your computer. Click on "FILE" then scroll down to select the required processor. Now click "DEVICE" and then "FIND ONLINE". The software will then attempt to connect to the processor.

If you then select "HELP" and scroll down to "HELP" and click on this a user manual for the program will be loaded.

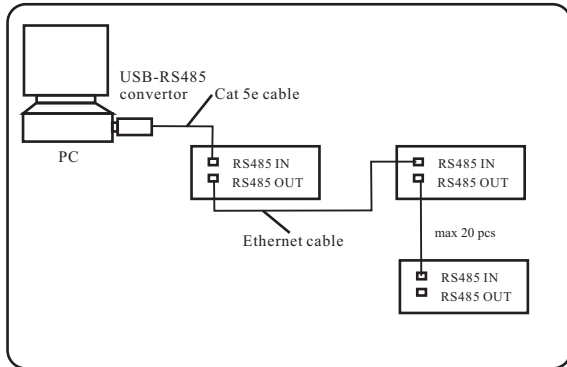
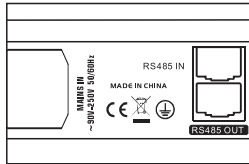

5.3 About the UI Operation, please refer to UI software manual.

6 Factory Reset

Function: This operation will reset the device to factory default settings, including issues caused by improper operation.

WARNING - Any user programs, device address and lock setting that your have created will be lost.

Operation: Press and hold the button SAVE / ENTER, then turn on the power switch on the rear panel till LCD displays the following.

**Resetting User Program
Please Wait...**

7 Troubleshooting

Issues	Troubleshooting Methods
No display on LCD screen and LCD lights.	<ol style="list-style-type: none"> 1 Check if the power cable is plugged in. 2 Check if the fuse is burned. 3 Make sure that the power switch is ON.
Single processor can not be connected with PC for Online control.	<ol style="list-style-type: none"> 1 Check if the communication cable is connected correctly 2 Close the software and connect the communication cable again, then open the software.
Multi processors can not be connected with PC for Online control.	<ol style="list-style-type: none"> 1 Check if the communication cable is connected correctly 2 Check if the ID addresses of the same model processors are setting differently. 3 Close the software and reconnect PC with the first processor RS485 IN. Open the software again.
No signal output at the output channel	<ol style="list-style-type: none"> 1 Check if the communication cable is connected correctly 2 Check if MUTE LED is on. Disable the mute function.

Accessories

Name	Quantity
Software CD	1
USB Online Cable	1
Power Cable	1
User Manual	1

Signal Flow Chart

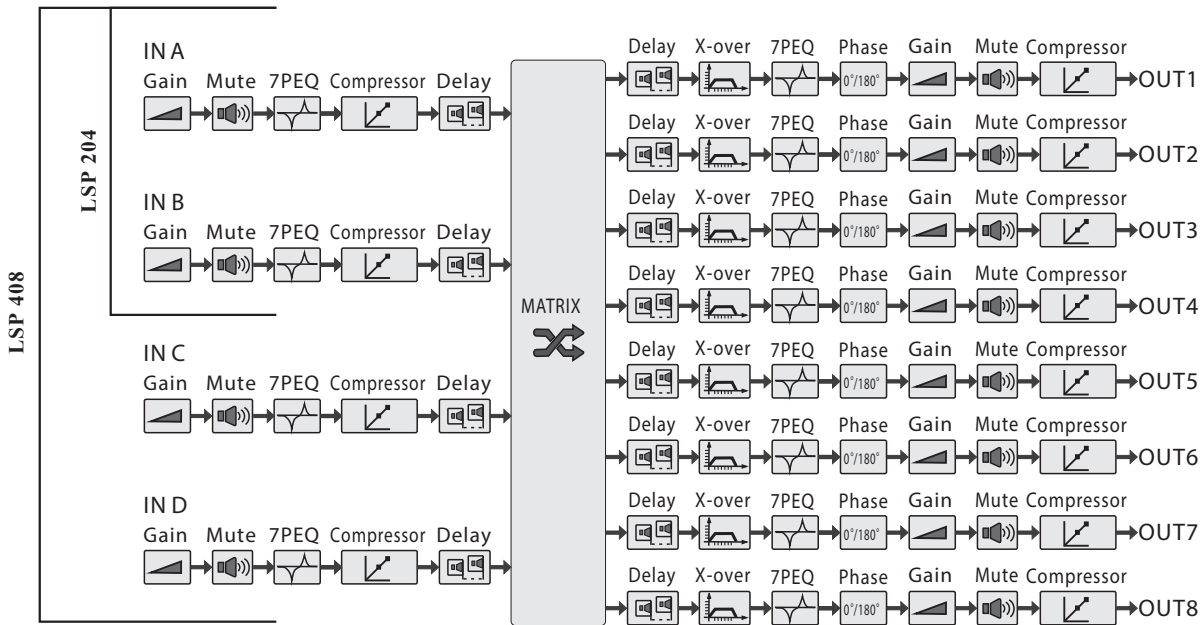

Specifications

Number of Input Channel	4 (LSP 408) / 2 (LSP 204)
Number of Output Channel	8 (LSP 408) / 4 (LSP 204)
Input Impedance	10 k Ω
Output Impedance	50 Ω
Maximum Input Level	19dBu
Maximum Output Level.....	19dBu
Sampling Frequency	48 kHz
Input Gain	-40 dB ~ +12 dB, steps 0.1 dB
Output Gain	-40 dB ~ +12 dB, steps 0.1 dB
Input Delay.....	1s steps 21 μ s
Output Delay	1s steps 21 μ s
Input EQ Number	7 Bands
Output EQ Number	7 Bands
Input / Output EQ Gain	-30 dB ~ +15 dB, steps 0.1 dB
Input / Output EQ Type	PEQ, Low-Shelf 6 dB/12 dB, High shelf 6 dB/12 dB
Input / Output EQ Frequency.....	19.7 Hz ~ 21.9 kHz
Input / Output EQ Bandwidth	0.017 ~ 4.750 Oct
High / Low-Pass Filter Frequency	19.7 Hz ~ 21.9 kHz
High / Low-Pass Filter Type	Bessel, Butterworth, Linkwitz-Riley
High / Low-Pass Filter Slope.....	12 dB/Oct, 24dB/Oct, 36dB/Oct, 48dB/Oct
Compressor Threshold	- 20 dBu ~ +20 dBu, steps 0.5dBu
Compressor Ratio	1.2, 1.5, 2, 3, 4, 6, 10, 20, 40, 128
Input / Output Compressor Attack-Time	1 ms ~100 ms, steps 1ms
Input / Output Compressor Release-Time	50 ms ~1000 ms, steps 50 ms
Dynamic Range	116dB A-Weighted
Frequency Response	20 Hz ~ 20 kHz (\pm 0.5 dB)
CMRR	> 50 dB (30 Hz~20 kHz)
Crosstalk	< - 100dB
THD+N	0.003% (1 kHz, + 4 dBu)
Maximum Number of User Presets	30
Mains Input Voltage & Frequency	90 V-250 Vac, 50/60 Hz
Fuse Size	T1AL, AC250 V
Net Weight	2.0 kg
Dimensions	482x 158x 45 (mm)



***Correct Disposal of this Product
(Waste Electrical & Electronic Equipment)***

**(Applicable in the European Union and other European countries
with separate collection systems)**

This marking shown on the product or its literature, indicates that it should not be disposed with other household wastes at the end of its working life. To prevent possible harm to the environment or human health from uncontrolled waste disposal, please separate this from other types of wastes and recycle it responsibly to promote the sustainable reuse of material resources.

Household users should contact either the retailer where they purchased this product, or their local government office, for details of where and how they can take this item for environmentally safe recycling.

Business users should contact their supplier and check the terms and conditions of the purchase contract. This product should not be mixed with other commercial wastes for disposal.

