

CLEVER

..... a c o u s t i c s
.....

www.cleveracoustics.co.uk

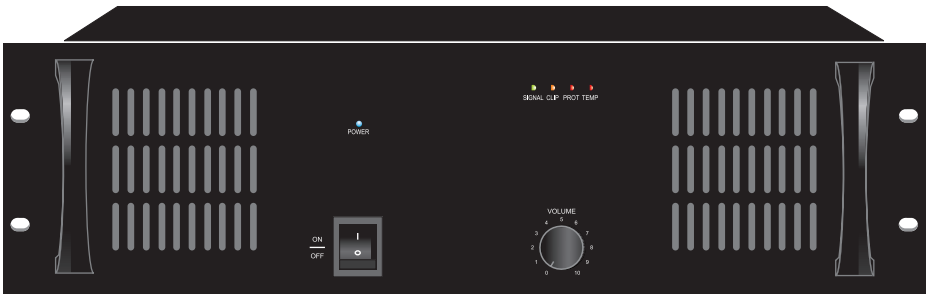
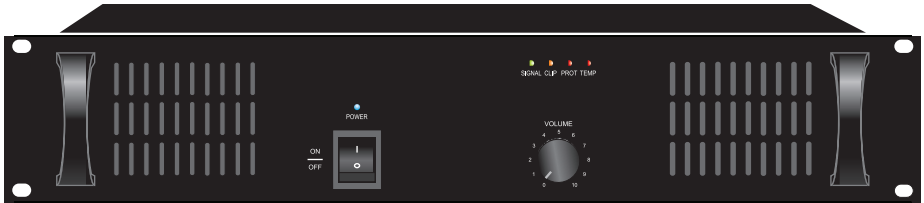

SL 120 100V 120W Slave Amplifier

Order code: CRAM11

SL 240 100V 240W Slave Amplifier

Order code: CRAM12

SL 350 100V 350W Slave Amplifier

Order code: CRAM13

USER MANUAL
.....

WARNING



**FOR YOUR OWN SAFETY, PLEASE READ THIS USER MANUAL CAREFULLY
BEFORE YOUR INITIAL START-UP!**

	<p>CAUTION!</p> <p>Keep this equipment away from rain, moisture and liquids.</p>	
---	--	---

SAFETY INSTRUCTIONS

Every person involved with the installation, operation & maintenance of this equipment should:

- Be competent
- Follow the instructions of this manual

	<p>CAUTION! TAKE CARE USING THIS EQUIPMENT! HIGH VOLTAGE-RISK OF ELECTRIC SHOCK!!</p>	
---	--	---

Before your initial start-up, please make sure that there is no damage caused during transportation. Should there be any, consult your dealer and do not use the equipment.

To maintain the equipment in good working condition and to ensure safe operation, it is necessary for the user to follow the safety instructions and warning notes written in this manual.

Please note that damages caused by user modifications to this equipment are not subject to warranty.

IMPORTANT:

The manufacturer will not accept liability for any resulting damages caused by the non-observance of this manual or any unauthorised modification to the equipment.

- Never let the power-cable come into contact with other cables. Handle the power-cable and all mains voltage connections with particular caution!
- Never remove warning or informative labels from the equipment.
- Do not open the equipment and do not modify the equipment.
- Do not switch the equipment on and off in short intervals, as this will reduce the system's life.
- Only use the equipment indoors.
- Do not expose to flammable sources, liquids or gases.
- Do not carry the unit with only one handle. Always carry using both handles.
- Always disconnect the power from the mains when equipment is not in use or before cleaning! Only handle the power-cable by the plug. Never pull out the plug by pulling the power-cable.
- Make sure that the available voltage is between 220V-240V.
- Make sure that the power-cable is never crimped or damaged. Check the equipment and the power-cable periodically.
- If the equipment is dropped or damaged, disconnect the mains power supply immediately.
Have a qualified engineer inspect the equipment before operating again.
- If the equipment has been exposed to drastic temperature fluctuation (e.g. after transportation), do not switch it on immediately. The arising condensation might damage the equipment. Leave the equipment switched off until it has reached room temperature.
- If your product fails to function correctly, discontinue use immediately. Pack the unit securely (preferably in the original packing material), and return it to your Prolight dealer for service.
- Only use fuses of same type and rating.
- Repairs, servicing and power connection must only be carried out by a qualified technician. THIS UNIT CONTAINS NO USER SERVICEABLE PARTS.
- WARRANTY; One year from date of purchase.
- If this equipment is operated in any other way, than those described in this manual, the product may suffer damage and the warranty becomes void.
- Incorrect operation may lead to danger e.g.: short-circuit, burns, electric shocks.
- Do not endanger your own safety and the safety of others!
Incorrect installation or use can cause serious damage to people and property.

This 100V line slave amplifier was designed specifically for use in permanent audio installations, where reliability and premium sound quality are a must. Highly rugged construction and high efficiency design make this amplifier perfect for continuous duty applications in situations where power will be left on for indefinite periods of time.

This 100V line amplifier is warranted from defects for one year from the date of purchase. Should your amplifier require service, either within or beyond that warranty period, please contact your Prolight Dealer.

This unit includes a host of features, along with an impressive list of specifications, which are detailed over the next pages. Please take the time to read this document completely prior to installation of this product.

Slave amplifier series are designed to suit all PA system application in schools, offices and stor

Features

- 70V, 100V and 4-16Ω loudspeaker outputs
- Balanced XLR line input
- Unbalanced 6.35mm jack line input
- Balanced XLR line output
- Unbalanced 6.35mm jack line output
- Temperature, clip and short circuit protection
- Power, signal, clip, protection and temperature LEDs
- GND/lift switch to prevent ground loop hum
- Fan cooled
- 24V DC and 240V AC inputs for maximum flexibility

Specifications	SL 120	SL 240	SL 350
Power output:	120Wrms / 135W peak	240Wrms / 255Wpeak	350Wrms / 375Wpeak
Speaker outputs:	70V, 100V & 4-16Ω	70V, 100V & 4-16Ω	70V, 100V & 4-16Ω
Sensitivity:	775mV (0dB)	775mV (0dB)	775mV (0dB)
S/N ratio:	>105dB	>105dB	>105dB
Frequency response:	50Hz-18kHz	50Hz-18kHz	50Hz-18kHz
THD:	<1% @ 1kHz, 1/3 rated power	<1% @ 1kHz, 1/3 rated power	<1% @ 1kHz, 1/3 rated power
Controls:	Power, volume, GND, LIFT	Power, volume, GND, LIFT	Power, volume, GND, LIFT
Indications:	Power, signal, clip, temp and protect	Power, signal, clip, temp and protect	Power, signal, clip, temp and protect
Protection:	AC fuse, short circuit, clipping and high temperature	AC fuse, short circuit, clipping and high temperature	AC fuse, short circuit, clipping and high temperature
Power consumption:	200W	400W	500W
DC power supply:	24V DC	24V DC	24V DC
AC power supply:	240V-60Hz	240V-60Hz	240V-60Hz
Dimensions (H x W x D):	88 x 484 x 353mm	88 x 484 x 353mm	132 x 484 x 408mm
Weight:	9.3kg	13.2kg	14.5kg
Order code:	CRAM11	CRAM12	CRAM13

Overview:

SL120, SL 240

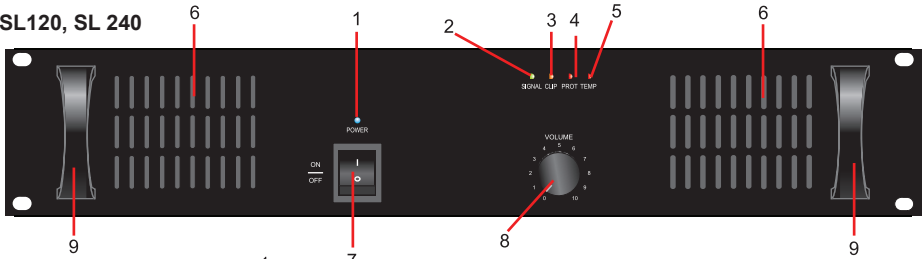

SL 350

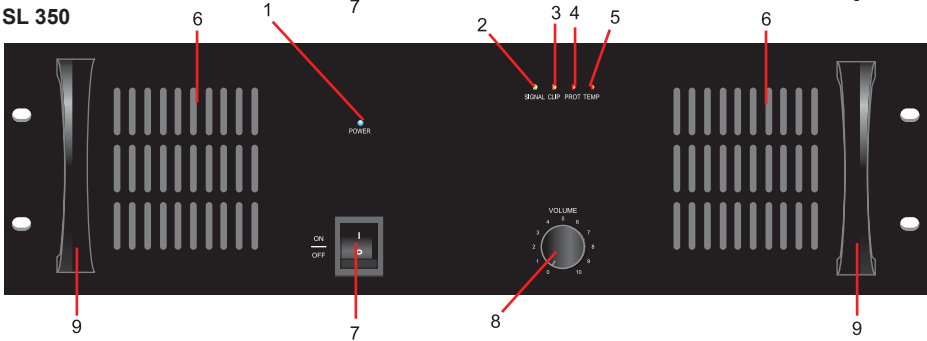

SL120, SL 240

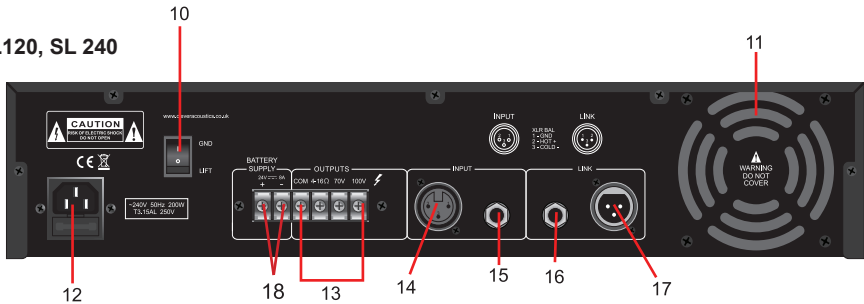

SL 350

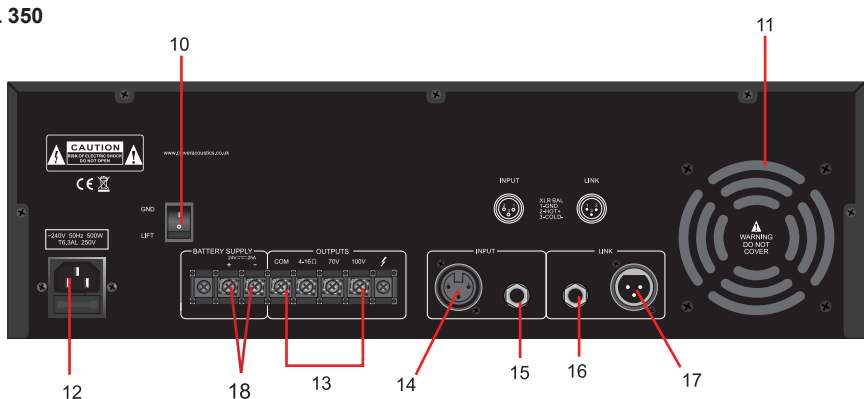

Identification:

- 1. **Power LED** - This LED will light up once the amp is switched on
- 2. **SIGNAL LED** - This LED will light up when signal is being received
- 3. **CLIP LED** - This LED will flash when the output signal starts to distort. At this point turn the master volume anti-clockwise to prevent damage.
- 4. **PROT LED** - This LED will illuminate when the unit goes into protect mode. Switch off the amplifier and check the output connections for faults or short circuits before powering on and resuming operation.
- 5. **TEMP LED** - Temperature LED will illuminate when overheating. Switch off the amplifier and leave to cool down.
- 6. **FAN Vent** - Do not obstruct, keep clear of dust
- 7. **On/off power switch** - Use the switch to power the unit on or off
- 8. **Master volume control** - Use this control to increase or decrease the master volume
- 9. **Carry handles**
- 10. **GND/LIFT switch** - Switch to "GND" position when one unit is used, switch lift "LIFT" when several units are used to avoid noise caused by several earth line grounded.
- 11. **DC LED** - This LED will light up when optional DC power supply is used
- 12. **FAN Vent** - Do not cover to avoid overheating
- 13. **Speaker outputs** - Use these to connect the speakers
- 14. **XLR input** - Use this to connect signal input from mixer amplifiers
- 15. **6.35mm mono jack input** - Use this to connect signal input from mixer amplifiers
- 16. **6.35mm mono jack link** - Use this to link out to additional slave amplifiers
- Rack Installation** - Use this to link out to out to additional slave amplifiers
- DC Connections** - Use this to connect to optional 24V DC power supply where you can open the front and rear panel. When mounting the amplifier into the rack, please make sure that there is enough space around the amplifier.

Be careful when mounting the amplifier into the rack. Put the heaviest products into the lower part of the rack. Be aware that fastening the amplifier with four screws on the front panel is not enough.

Inputs

Short cables runs improve the sound quality remarkably. Input cables should be short and direct, since high frequencies will mostly be absorbed if the cables are unnecessarily long. Besides that a longer cable may lead to humming and noise problems. If the cable runs are unavoidable, you should use balanced cables.

Outputs

The high damping factor of your amplifier supplies a clear sound reproduction. Unnecessarily long and thin cables used for low impedance (4-16Ω) speakers will influence the damping factor and thus the low frequencies in a negative way.

Connect your speaker systems via the speaker terminals (COM = -VE)

- Examples: 1) COM + 4-16Ω
- 2) COM + 70V
- 3) COM + 100V

Note: Please do not use more than one pair of output terminals

Connections To The Mains

Before connecting the amplifier to the local mains voltage outlet should be checked to ensure the available supply is 240V~AC 50Hz. This product is CLASS1 and requires a protective mains earth to be connected at all times. DO NOT remove or disconnect the earth.

Power On/Off Procedure

After connecting your amplifier to the mains, turn all controls counter clockwise to the “min” position. Turn on audio sources (MP3 players, CD players, Microphones etc) before powering the amplifier ON. The last product to be switched on is the amplifier.

If you wish to power off the system, turn the amplifier’s master volume control counter clockwise to the “min” position before switching the amplifier OFF before any audio sources are switched off. By following this procedure it will prevent acoustic shocks to the speakers or potential damage to system components.

Machine operation

1. After connecting all audio source and powering on the power amplifier, adjust the and the master volume.
2. The Clever Acoustics amplifier features output signal LED with PEAK indication. Should the PEAK indicator illuminate (flashing) the output of the amplifier is too high, turn the master volume anti-clockwise to reduce the output.
3. The Clever Acoustics amplifier all features protection with LED indication. Should the PROTECT indicator illuminate, turn the master volume control anti-clockwise fully and switch off the amplifier for 15 seconds as the amplifier may have entered PROTECT mode temporarily due to a peak signal, care should then be taken to ensure all input levels are set correctly. If the amplifier persists to enter PROTECT mode the amplifier should be switched off and left to cool for 5-10 minutes before switching back on. If the PROTECT indicator remains lit this indicates a problem with the amplifier or amplifier load (ie Short Circuit).
4. Speaker & Amplifier systems can produce high sound pressure levels, please operate all controls with caution to ensure people are not exposed to excessive or dangerous sound pressure levels.

Panel Connections:

SL 120, 240, 350

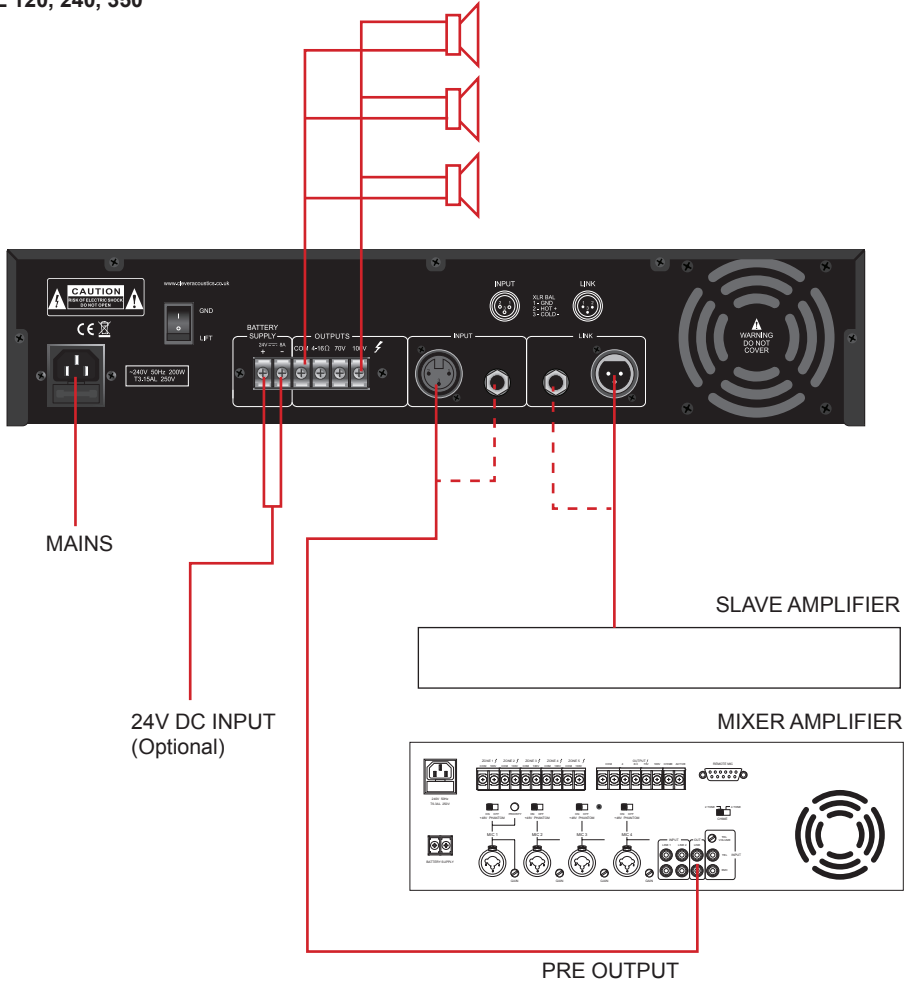

Speaker connections:

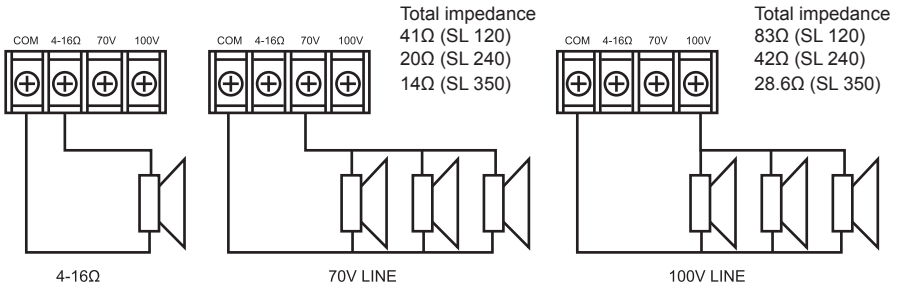

Notes:

- Both the 4 - 16Ω, 70V and 100V terminals cannot be used at the same time.
- Impedances indicated in the figures represent the total speaker system (load) impedances. Loads presented to the amplifier must be equal to or greater than listed above. Speaker impedances must be measured using a true impedance meter, do not standard multimeters.



WARNING!

Be sure to attach the supplied terminal cover attached after connection. Because high voltage is applied to the speaker terminals, car should be taken never touch these terminals to avoid electric shock.

All speaker connections should be made using bare wire or suitable insulated crimp terminals. Please ensure no loose strands are present as these may short across terminals causing damage to the amplifier



Connection With The Mains

Connect the unit to the mains via the IEC mains inlet using the 13A UK - IEC cord supplied.

The earth has to be connected.

Switch the unit on. After switching on the speaker system, wait 8 - 10 seconds before you turn the volume control up in order to avoid speaker damage.

CAUTION! Increase the level of each channel up to the point where the clip LEDs illuminate.

Always check the sound pressure level with a meter in order to keep to the legal threshold.

Balanced XLR Jack Connection

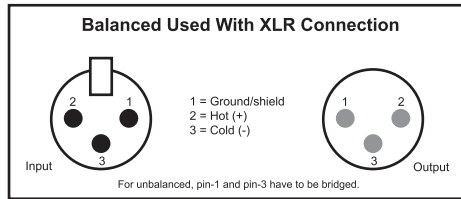

Jack Plug

**Unbalanced mono
1/4" jack plugs**

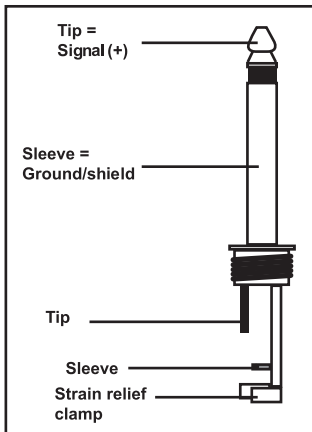

**Balanced/stereo
1/4" jack plugs**

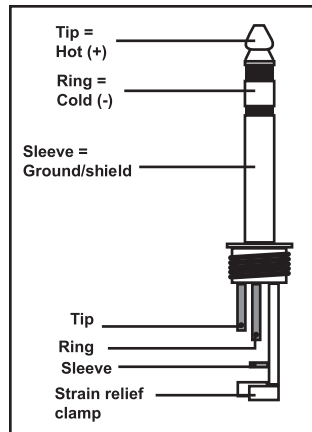

For connection of balanced and unbalanced plugs, the ring and sleeve have to be bridged in the stereo plug.

Problem Chart

PROBLEM	CAUSE	REMEDY
No Power	The power cord is not connected	Check the power cord and any extension cables
No Sound	The power cord of the respective product is not connected properly or not at all. The connection socket or the plug is dirty.	Check the power cord and if the plugs are properly connected with the sockets. Clean the socket and/or the plug.
Noise	The input signal is too strong	Reduce the input signal via the gain control.
Distorted Sound	Load impedance is to low	Check load impedance vs amplifier specification, reduce as required.

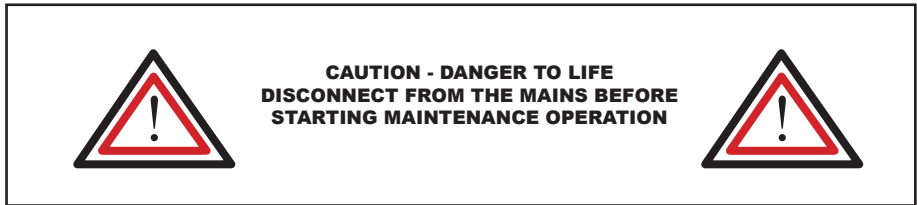

Cleaning and Maintenance

We recommend a frequent cleaning of the product. Please use a soft lint free and moistened cloth. Never use alcohol or solvents.

There are no serviceable parts inside the product except for the fuse. Maintenance and service operations are only to be carried out by authorised dealers.

Replacing the fuse

Only replace the fuse by a fuse of the same type and rating.

Before replacing the fuse, unplug the mains lead.

Should you need any spare parts, please use genuine parts.

Should you have any further questions, please contact your dealer.

English



**Correct Disposal of This Product
(Waste Electrical & Electronic Equipment)**

(Applicable in the European Union and other European countries with separate collection systems)

This marking shown on the product or its literature, indicates that it should not be disposed with other household wastes at the end of its working life. To prevent possible harm to the environment or human health from uncontrolled waste disposal, please separate this from other types of wastes and recycle it responsibly to promote the sustainable reuse of material resources.

Household users should contact either the retailer where they purchased this product, or their local government office, for details of where and how they can take this item for environmentally safe recycling.

Business users should contact their supplier and check the terms and conditions of the purchase contract. This product should not be mixed with other commercial wastes for disposal.



CLEVER
a c o u s t i c s

www.cleveracoustics.co.uk

