

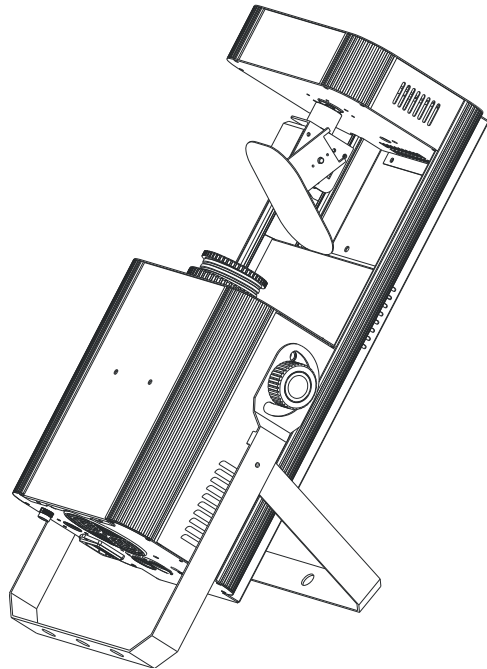

WARRIOR SCAN 50



LED-SC50C

User Guide

Professional Entertainment Technology

TABLE OF CONTENTS

1. Safety Instruction
2. Technical Specification
3. How To Set The Unit
4. How To Control The Unit
5. Update Software
6. Troubleshooting
7. Fixture Cleaning

1. Safety Instruction



WARNING

Please read carefully the instruction, which includes important information about the installation, usage and maintenance.

- Please keep this User Guide for future consultation. If you sell the unit to another user, be sure that they also receive this instruction booklet.
- Unpack and check carefully there is no transportation damage before using the unit.
- Before operating, ensure that the voltage and frequency of power supply match the power requirements of the unit.
- It's important to ground the yellow/green conductor to earth in order to avoid electric shock.
- The unit is for indoor use only. Use only in a dry location.
- The unit must be installed in a location with adequate ventilation, at least 50cm from adjacent surfaces. Be sure that no ventilation slots are blocked.
- Disconnect main power before replacement or servicing.
- Make sure there is no flammable materials close to the unit while operating as it is fire hazard.
- Use safety cable when fixes this unit. Don't handle the unit by taking its head only, but always by taking its base.
- Maximum ambient temperature is $t_a: 40^{\circ}\text{C}$. Don't operate it where the temperature is higher than this.
- Unit surface temperature may reach up to 85°C . Don't touch the housing bare-hand during its operation. Turn off the power and allow about 15 minutes for the unit to cool down before replacing or serving.
- In the event of serious operating problem, stop using the unit immediately. Never try to repair the unit by yourself. Repairs carried out by unskilled people can lead to damage or malfunction. Please contact the nearest authorized technical assistance center. Always use the same type spare parts.
- Do not touch any wire during operation as high voltage might be causing electric shock.

Warning

- To prevent or reduce the risk of electrical shock or fire, do not expose the unit to rain or moisture.
- Do not open the unit within five minutes after switching off.

- The housing, the lenses, or the ultraviolet filter must be replaced if they are visibly damaged.

Caution

There are no user serviceable parts inside the unit. Do not open the housing or attempt any repairs yourself. In the unlikely event your unit may require service, please contact your nearest dealer.

Installation

The unit should be mounted via its screw holes on the bracket. Always ensure that the unit is firmly fixed to avoid vibration and slipping while operating. And make sure that the structure to which you are attaching the unit is secure and is able to support a weight of 10 times of the unit's weight. Also always use a safety cable that can hold 12 times of the weight of the unit when installing the fixture.

The equipment must be fixed by professionals. And it must be fixed at a place where is out of the touch of people and has no one pass by or under it.

2. Technical Specification

High powered 50W LED and perfect optical system make the scanner with extraordinary performance.

DMX control: 7/8 channels.

3 operation modes: DMX, Master/Slave and Sound Active.

Great built-in lighting shows under Master/Slave mode triggered by music.

Optional CA-8 easy controller or CA-9 RTX (wireless easy control kit) for instant lighting shows.

Gobo wheel with 8 gobos plus white.

Color wheel with 8 colors plus white.

Smooth 0~100% dimming and variable strobe speeds.

Ideal for pubs, clubs, Mobile DJs, etc.

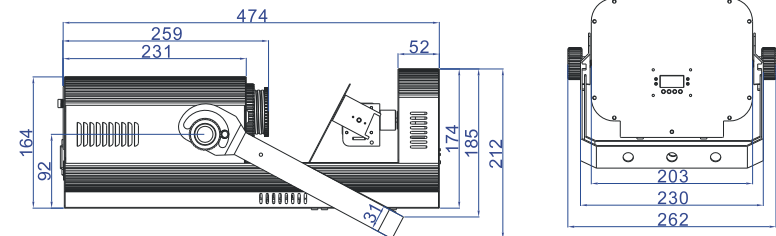

Voltage: 230V/50Hz

Power consumption: 105W

Light source: 1 × 50W LED

Dimension: 262X212X474 mm

Weight: 7.4 kg

3. How To Set The Unit

3.1 Control panel

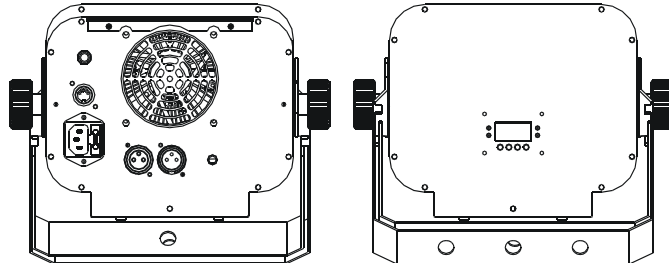

Display

To show the various menus and the selected functions

LED

DMX	On	DMX input present
MASTER	On	Master Mode
SLAVE	On	Slave Mode
SOUND	Flashing	Sound activation

Button

MENU	To select the programming functions
DOWN	To go backward in the selected functions
UP	To go forward in the selected functions
ENTER	To confirm the selected functions

Only for remote control

Connecting with CA-8/CA-9/CA-9RTX to control the unit for Stand by, Function and Mode function.

Mains input

Connect to power supply.

DMX input/output

For DMX512 link, use 3/5-pin XLR cable to link the unit together.

3.2 Main Function

To select any of the given functions, press the **MENU** button up to when the required one is showing on the display. Select the function by **ENTER** button and the display will blink. Use **DOWN** and **UP** button to change the mode. Once the required mode has been selected, press the **ENTER** button to setup, to go back to the functions without any change press the **MENU** button again. Hold and press the **MENU** button about one second or wait for one minute to exit the menu mode.

The main functions are showing below:

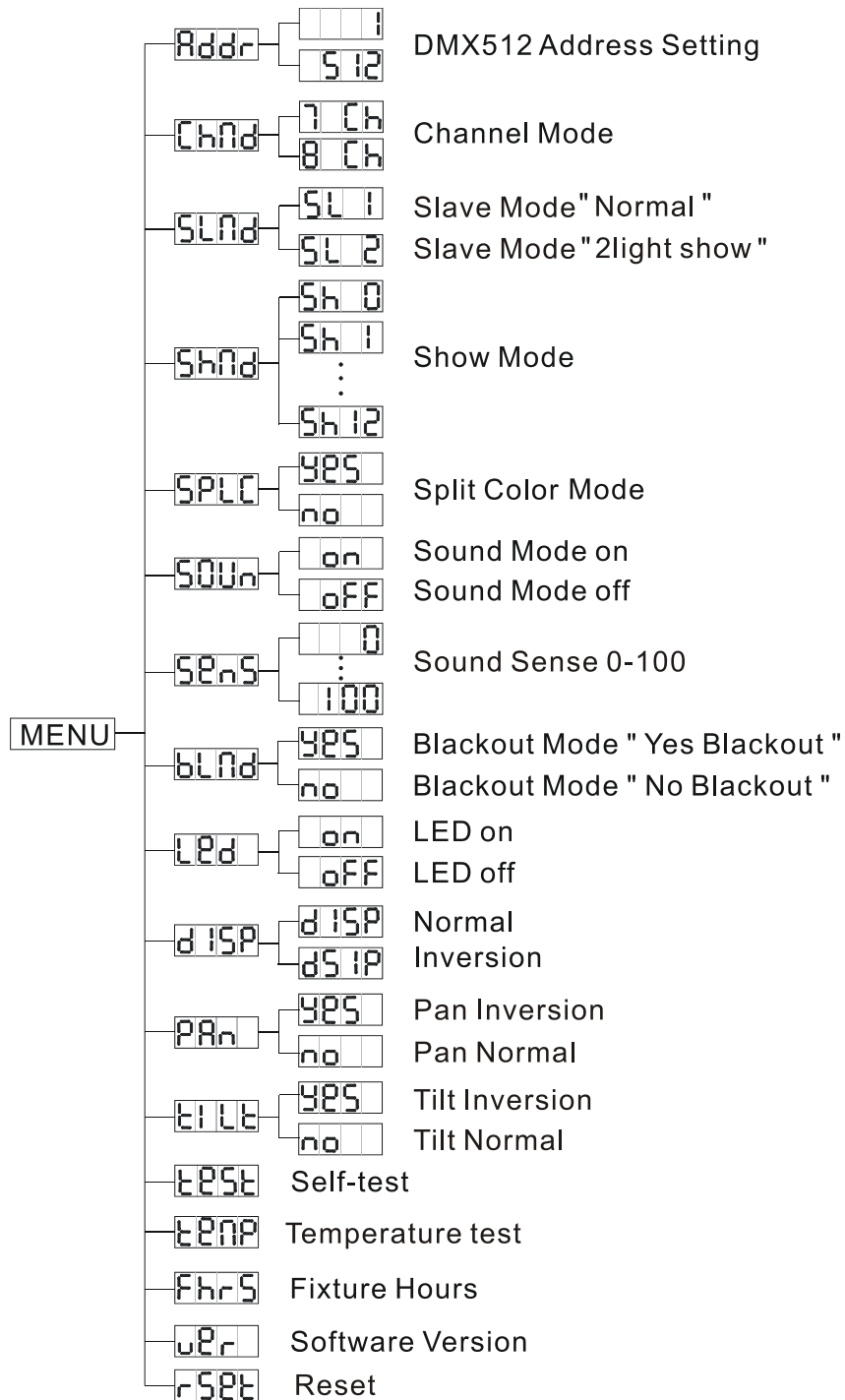

Addr DMX 512 Address Setting

Press the **MENU** button to show **Addr** on the display. Press the **ENTER** button and the display will blink. Use the **DOWN** and **UP** buttons to change the DMX512 address. Once the address has been selected, press the **ENTER** button to setup, to go back to the functions without any change press the **MENU** button again. Hold and press the **MENU** button about one second or wait for one minute to exit the menu mode.

ChNd Channel Mode

Press the **MENU** button to show **ChNd** on the display. Press the **ENTER** button and the display will blink. Use the **DOWN** and **UP** button to select the **7 CH** (7 channel) or **8 CH** (8 channel) mode. Once the mode has been selected, press the **ENTER** button to setup, to go back to the functions without any change press the **MENU** button again. Hold and press the **MENU** button about one second or wait for one minute to exit the menu mode.

SLNd Slave Mode

Press the **MENU** button to show **SLNd** on the display. Press the **ENTER** button and the display will blink. Use the **DOWN** and **UP** button to select the **SL 1** (normal) or **SL 2** (2 light show) mode. Once the mode has been selected, press the **ENTER** button to setup, to go back to the functions without any change press the **MENU** button again. Hold and press the **MENU** button about one second or wait for one minute to exit the menu mode.

SHNd Show Mode

Press the **MENU** button to show **SHNd** on the display. Press the **ENTER** button and the display will blink. Use the **DOWN** and **UP** button to select the **Sh 0** (random show) or **Sh 1** (show 1) or... or **Sh 12** (show 12) mode. Once the mode has been selected, press the **ENTER** button to setup, to go back to the functions without any change press the **MENU** button again. Hold and press the **MENU** button about one second or wait for one minute to exit the menu mode.

SPLC Split Color Mode

Press the **MENU** button to show **SPLC** on the display. Press the **ENTER** button and the display will blink. Use the **DOWN** and **UP** button to select the **YES** (Split color mode) or **no** (normal) mode. Once the mode has been selected, press the **ENTER** button to

setup, to go back to the functions without any change press the **MENU** button again. Hold and press the **MENU** button about one second or wait for one minute to exit the menu mode.

SOUN Sound Mode

Press the **MENU** button to show **SOUN** on the display. Press the **ENTER** button and the display will blink. Use the **DOWN** and **UP** button to select the **ON** (sound on) or **OFF** (sound off) mode. Once the mode has been selected, press the **ENTER** button to setup, to go back to the functions without any change press the **MENU** button again. Hold and press the **MENU** button about one second or wait for one minute to exit the menu mode.

SENS Sound Sense 0-100

Press the **MENU** button to show **SENS** on the display. Press the **ENTER** button and the display will blink. Use the **DOWN** and **UP** button to select the **0000** ... **1000** mode. Once the mode has been selected, press the **ENTER** button to setup, to go back to the functions without any change press the **MENU** button again. Hold and press the **MENU** button about one second or wait for one minute to exit the menu mode.

BLND Blackout Mode

Press the **MENU** button to show **BLND** on the display. Press the **ENTER** button and the display will blink. Use the **DOWN** and **UP** button to select the **YES** (yes blackout) or **NO** (no blackout) mode. Once the mode has been selected, press the **ENTER** button to setup, to go back to the functions without any change press the **MENU** button again. Hold and press the **MENU** button about one second or wait for one minute to exit the menu mode.

LED Led Display

Press the **MENU** button to show **LED** on the display. Press the **ENTER** button and the display will blink. Use the **DOWN** and **UP** button to select the **ON** (Led on) or **OFF** (Led off) mode. Once the mode has been selected, press the **ENTER** button to setup, to go back to the functions without any change press the **MENU** button again. Hold and press the **MENU** button about one second or wait for one minute to exit the menu mode.

DISP Display Inversion

It is good for you to install the unit on the floor or under ceiling. Press the **MENU** button to show **DISP** on the display. Press the **ENTER** button to change to the mode **DISP**

(display normal), It will automatically store after 8 seconds. Or press the **ENTER** button again return to the mode **DISP** (display inversion). To go back to the functions press the **MENU** button. Hold and press the **MENU** button about one second or wait for one minute to exit the menu mode.

DISP Display normal mode for the fixture putting on the floor.

DISP Display inversion mode for the fixture fixing under ceiling.

PAN Pan Inversion

Press the **MENU** button to show **PAN** on the display. Press the **ENTER** button and the display will blink. Use the **DOWN** and **UP** button to select the **NO** (normal) or **YES** (pan inversion) mode. Once the mode has been selected, press the **ENTER** button to setup, to go back to the functions without any change press the **MENU** button again. Hold and press the **MENU** button about one second or wait for one minute to exit the menu mode.

TILT Tilt Inversion

Press the **MENU** button to show **TILT** on the display. Press the **ENTER** button and the display will blink. Use the **DOWN** and **UP** button to select the **NO** (normal) or **YES** (tilt inversion) mode. Once the mode has been selected, press the **ENTER** button to setup, to go back to the functions without any change press the **MENU** button again. Hold and press the **MENU** button about one second or wait for one minute to exit the menu mode.

TEST Self-Test

Press the **MENU** button to show **TEST** on the display. Press the **ENTER** button and the unit will run self-test by built-in program. To go back to the functions press the **MENU** button again. Hold and press the **MENU** button about one second or wait for one minute to exit the menu mode.

TEMP Temperature Test

Press the **MENU** button to show **TEMP** on the display. Press the **ENTER** button and the display will show the temperature of the unit. To go back to the functions press the **MENU** button again. Hold and press the **MENU** button about one second or wait for one minute to exit the menu mode.

FHFS Fixture Hours

Press the **MENU** button to show **Fhrs** on the display. Press the **ENTER** button and the display will show the number of working hours of the unit. To go back to the functions press the **MENU** button again. Hold and press the **MENU** button about one second or wait for one minute to exit the menu mode.

ver Software version

Press the **MENU** button to show **ver** on the display. Press the **ENTER** button and the display will show the version of software of the unit. To go back to the functions press the **MENU** button again. Hold and press the **MENU** button about one second or wait for one minute to exit the menu mode.

rset Reset

Press the **MENU** button to show **rset** on the display. Press the **ENTER** button and all channels of the unit will return to their standard position. To go back to the functions without any change press the **MENU** button again. Hold and press the **MENU** button about one second or wait for one minute to exit the menu mode.

4. How To Control The Unit

You can operate the unit in three ways:

1. Master/slave built-in preprogram function
2. Easy controller
3. Universal DMX controller

No need to turn the unit off when you change the DMX address, as new DMX address setting will be effect at once. Every time you turn the unit on, it will show **5050** on the display and move all the motors to their 'home' position and you may hear some noises for about 20 seconds. After that the unit will be ready to receive DMX signal or run the built in programs.

4.1 Master/Slave Built In Preprogrammed Function

By linking the units in master/slave connection, the first unit will control the other units to give an automatic, sound activated, synchronized light show. This function is good when you want an instant show. You have to set the first unit in master mode **SLnd** and select **SH0** (random show) or **SH1** (show 1) or... or **SH12** (show 12) mode. Its DMX input jack will have nothing plugged into it, and Its master LED will be constantly on and sound

LED will flash to the music. The other units will have to set in slave mode **SLnd** and select **SL1** (normal) or **SL2** (2 light show) mode, Their DMX cables plugged into the DMX input jacks (daisy chain) and the slave led lights will constantly on.

2-light show

In **SLnd** (slave mode), **SL1** means the unit works normally and **SL2** means 2-light show. In order to create a great light show, you can set **SL2** on the second unit to get contrast movement to each other, even if you have two units only.

4.2 Easy Controller

The easy remote control is used only in master/slave mode. By connecting to the 1/4" microphone jack of the first unit, you will find that the remote control on the first unit will control all the other units functions press the MENU button again.

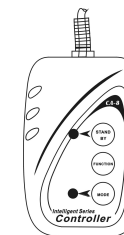

Stand By	Blackout the unit		
Function	1. Strobe in synchronization 2. Strobe in desynchronization 3. Strobe by music	Select Movement 1-12	Color/Gobo selection 1. Press shortly for color change. 2. Hold on for Gobo change.
Mode	Sound(LED OFF)	Movement (LED Blinking)	GOBO/Color (LED ON)

4.3 DMX Controller

By using a universal DMX controller to control the units, you have to set DMX address from 1 to 512 channel so that the units can receive DMX signal.

Press the **MENU** button up to when the **Addr** is showing on the display. Pressing **ENTER** button and the display will blink. Use **DOWN** and **UP** button to change the DMX512 address. Once the address has been selected, press and keep **ENTER** button pressed up to when the display stops blinking or storing automatically 8 seconds later. To go back to the functions without any change press the **MENU** button again. If you use please refer to the following diagram to address your DMX512 channel for the first 4 units:

7 Channel Mode:

			1				8				15			22
--	--	--	---	--	--	--	---	--	--	--	----	--	--	----

8 Channel Mode:

			1				9				15			23
--	--	--	---	--	--	--	---	--	--	--	----	--	--	----

4.4 DMX 512 Configuration

7 channel mode:

7 Channel mode			
Ch1	Ch2	Ch3	Ch4
Pan	Tilt	Strobe	Gobo
<p>255 540° 0 0°</p>	<p>255 270° 0 0°</p>		<p>255 Rotation Fast</p> <p>128 Rotation Slow 121-127 Gobo8 shaking 114-120 Gobo7 shaking 107-113 Gobo6 shaking 100-106 Gobo5 shaking 093-099 Gobo4 shaking 086-092 Gobo3 shaking 079-085 Gobo2 shaking 072-078 Gobo1 shaking 064-071 Open shaking 057-063 Gobo8 050-056 Gobo7 043-049 Gobo6 036-042 Gobo5 029-035 Gobo4 022-028 Gobo3 015-021 Gobo2 008-014 Gobo1 000-007 Open</p>
Ch5		Ch6	Ch7
Color Wheel (Normal)	Color Wheel (Split Color Mode)	Dimmer	Function
<p>255 Rotation Fast</p> <p>128 Rotation Slow</p> <p>113-127 Color8 099-112 Color7 085-098 Color6 071-084 Color5 057-070 Color4 043-056 Color3 029-042 Color2 015-028 Color1 000-014 White</p>	<p>255 Rotation Fast</p> <p>128 Rotation Slow</p> <p>120-127 Color16 113-119 Color15 109-112 Color14 099-105 Color13 092-098 Color12 085-091 Color11 078-084 Color10 071-077 Color9 064-070 Color8 057-063 Color7 050-056 Color6 043-049 Color5 036-042 Color4 029-035 Color3 022-028 Color2 015-021 Color1 000-014 White</p>	<p>255 100% 0 0%</p>	<p>240-255 Stand-Alone 210-239 No Function 200-209 Reset All 130-199 No function 120-129 Disable blackout while Gobo change 110-119 Enable blackout while Gobo change 100-109 Disable blackout while Color change 090-099 Enable blackout while Color change 080-089 Disable blackout while Pan/Tilt move 070-079 Enable blackout while Pan/Tilt move 000-069 No Function</p>

8 channel mode:

8 Channel mode				
Ch1	Ch2	Ch3	Ch4	
Pan	Tilt	Strobe	Gobo	
<p>255 540° 0 0°</p>	<p>255 270° 0 0°</p>		<p>255 Rotation Fast</p> <p>128 Rotation Slow 121-127 Gobo8 shaking 114-120 Gobo7 shaking 107-113 Gobo6 shaking 100-106 Gobo5 shaking 093-099 Gobo4 shaking 086-092 Gobo3 shaking 079-085 Gobo2 shaking 072-078 Gobo1 shaking 064-071 Open shaking 057-063 Gobo8 050-056 Gobo7 043-049 Gobo6 036-042 Gobo5 029-035 Gobo4 022-028 Gobo3 015-021 Gobo2 008-014 Gobo1 000-007 Open</p>	
Ch5		Ch6	Ch7	Ch8
Color Wheel (Normal)	Color Wheel (Split Color Mode)	No Function	Dimmer	Function
<p>255 Rotation Fast</p> <p>128 Rotation Slow</p> <p>113-127 Color8 099-112 Color7 085-098 Color6 071-084 Color5 057-070 Color4 043-056 Color3 029-042 Color2 015-028 Color1 000-014 White</p>	<p>255 Rotation Fast</p> <p>128 Rotation Slow</p> <p>120-127 Color16 113-119 Color15 109-112 Color14 099-105 Color13 092-098 Color12 085-091 Color11 078-084 Color10 071-077 Color9 064-070 Color8 057-063 Color7 050-056 Color6 043-049 Color5 036-042 Color4 029-035 Color3 022-028 Color2 015-021 Color1 000-014 White</p>		<p>255 100% 0 0%</p>	<p>240-255 Stand-Alone 210-239 No Function 200-209 Reset All 130-199 No function 120-129 Disable blackout while Gobo change 110-119 Enable blackout while Gobo change 100-109 Disable blackout while Color change 090-099 Enable blackout while Color change 080-089 Disable blackout while Pan/Tilt move 070-079 Enable blackout while Pan/Tilt move 000-069 No Function</p>

4.5 DMX512 Connection

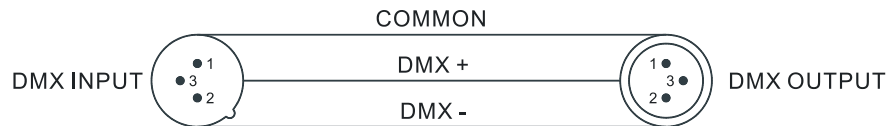
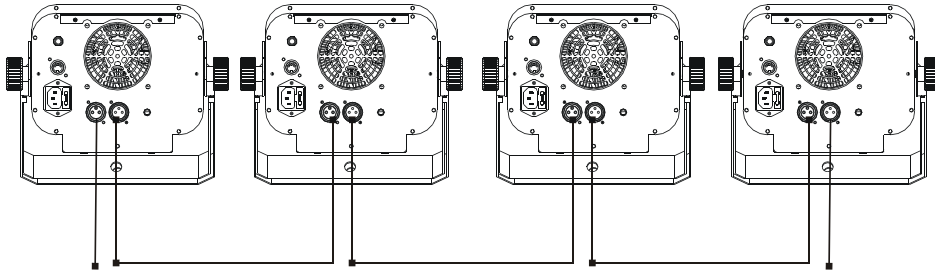

Termination reduces signal errors and avoids signal transmission problems and interference. It is always advisable to connect a DMX terminal. (Resistance 120 ohm 1/4W) between pin2(DMX-) and pin3(DMX+) of the last fixture.

1. If you using a controller with 5 pins DMX output, you need to use a 5 to 3 pin adapter-cable.
2. At last unit, the DMX cable has to be terminated with a terminator. Solder a 120 ohm 1/4W resistor between pin 2(DMX-) and pin 3(DMX+) into a 3-pin XLR-plug and plug it in the DMX-output of the last unit.
3. Connect the unit together in a `daisy chain` by XLR plug from the output of the unit to the input of the next unit. The cable can not branched or split to a `Y` cable. DMX 512 is a very high-speed signal. Inadequate or damaged cables, soldered joints or corroded connectors can easily distort the signal and shut down the system.
4. The DMX output and input connectors are pass-through to maintain the DMX circuit, when one of the units' power is disconnected.
5. Each lighting unit needs to have an address set to receive the data sent by the controller. The address number is between 0-511 (usually 0 & 1 are equal to 1).
6. The end of the DMX 512 system should be terminated to reduce signal errors.
7. 3 pin XLR connectors are more popular than 5 pin XLR.
3 pin XLR: Pin 1: GND, Pin 2: Negative signal (-), Pin 3: Positive signal (+)

5 pin XLR: Pin 1: GND, Pin 2: Negative signal (-), Pin 3: Positive signal (+), Pin 4/Pin 5: Not used.

5. Update Software

Download update file from our web site, follow the user manual of IU-01 to update the fixture via IU-01(not included).

6. Troubleshooting

Following are a few common problems that may occur during operation. Here are some suggestions for easy troubleshooting:

A. The unit does not work, no light and the fan does not work

1. Check the connection of power and main fuse.
2. Measure the mains voltage on the main connector.
3. Check the power on LED.

B. Not responding to DMX controller

1. DMX LED should be on. If not, check DMX connectors, cables to see if link properly.
2. If the DMX LED is on and no response to the channel, check the address settings and DMX polarity.
3. If you have intermittent DMX signal problems, check the pins on connectors or on PCB of the unit or the previous one.
4. Try to use another DMX controller.
5. Check if the DMX cables run near or run alongside to high voltage cables that may cause damage or interference to DMX interface circuit.

C. Some units don't respond to the easy controller

1. You may have a break in the DMX cabling. Check the LED for the response of the master/ slave mode signal.
2. Wrong DMX address in the unit. Set the proper address.

D. No response to the sound

1. Make sure the unit does not receive DMX signal.
2. Check microphone to see if it is good by tapping the microphone

E. One of the channels is not working well

1. The stepper motor might be damaged or the cable connected to the PCB is broken.

2. The motor's drive IC on the PCB might be out of condition

7. Fixture Cleaning

The cleaning of internal and external optical lenses and/or mirrors must be carried out periodically to optimize light output. Cleaning frequency depends on the environment in which the fixture operates: damp, smoky or particularly dirty surrounding can cause greater accumulation of dirt on the unit's optics.

- Clean with soft cloth using normal glass cleaning fluid.
- Always dry the parts carefully.
- Clean the external optics at least every 20 days. Clean the internal optics at least every 30/60 days.

EC Declaration of Conformity

We declare that our products (lighting equipments) comply with the following specification and bears CE mark in accordance with the provision of the Electromagnetic Compatibility (EMC) Directive 89/336/EEC.

EN55014-2: 1997 A1: 2001, EN61000-4-2: 1995; EN61000-4-3: 2002;

EN61000-4-4: 1995; EN61000-4-5: 1995, EN61000-4-6: 1996, EN61000-4-11: 1994.

&

Harmonized Standard

EN60598-1: 2000+ALL: 2000+A12: 2002
Safety of household and similar electrical appliances
Part 1: General requirements

Innovation, Quality, Performance