

iSolution™
Your integrated Solution

Xperior™ 300A Beam

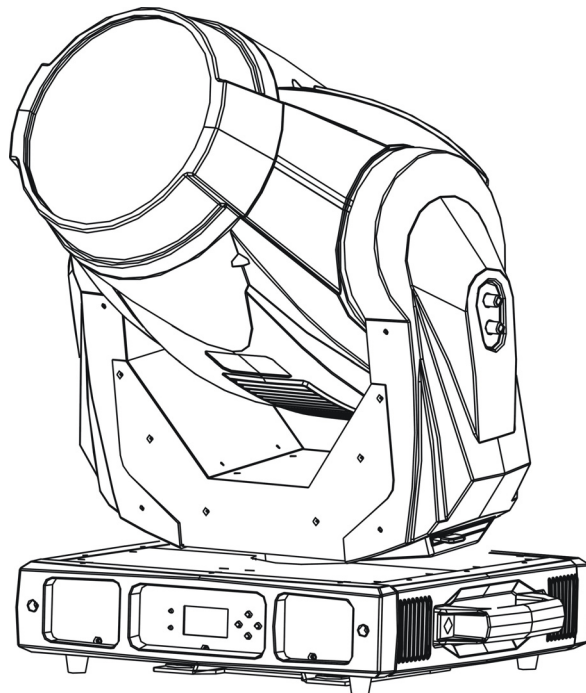

User Guide

Please read these instructions carefully before use

TABLE OF CONTENTS

1. Safety Instruction	3
2. Installation	5
3. Technical Specification	6
4. Description	9
4.1 Description of the fixture	9
4.2 Control Panel.....	9
5. Gobo and Lamp	10
5.1 Inserting/Exchanging rotating gobos	10
5.2 Lamp	11
6. How To Set The Unit	13
6.1 Power On Display	13
6.2 Main Function	13
6.3. Home Position Adjustment	23
6.4. Error Information.....	26
7. Control By Universal DMX Controller	27
7.1 Connection	27
7.2 Channel Mode Setting	28
7.3 Address Setting	29
7.4 DMX 512 Configuration	29
8. Update Software	35
9. Troubleshooting	35
10. Maintenance and Cleaning	36

1. Safety Instruction



WARNING

Please read carefully the instruction manual, which includes important information about the installation, usage and maintenance.

Please keep this User Guide for future consultation. If you sell the unit to another user, be sure that they also receive this instruction manual.

Important:

Damages caused by the disregard of this user manual are not subject to warranty.

The dealer will not accept liability for any resulting defects or problems.

- Unpack and check carefully that there is no transportation damage before using the unit.
- The unit is for indoor use only. Use only in a dry location.
- Do install and operate by qualified operator.
- Do not allow children to operate the fixture.
- Use safety chain when fixing the unit. Handle the unit by carrying its base instead of head only.
- The unit must be installed in a location with adequate ventilation, at least 50cm from adjacent surfaces.
- Be sure that no ventilation slots are blocked, otherwise the unit will be overheated.
- Before operating, ensure that the voltage and frequency of power supply matches the power requirements of the unit.
- It's important to ground the yellow/green conductor to earth in order to avoid electric shock.
- Maximum ambient temperature TA: 40°C. Don't operate it when the temperature is higher.
- Don't connect the device to any dimmer pack.
- During initial start-up some smoke or smell may arise. This is a normal process and does not necessarily mean that the device is defective, and it will decrease gradually within 15 minutes.
- Make sure there are no flammable materials close to the unit while operating to avoid fire hazard.
- Examine the power wires carefully; replace them immediately if there is any damage.
- Unit's surface temperature may reach up to 85°C. Don't touch the housing bare-handed

during its operation, and allow about 15 minutes for cooling the unit down before replacing bulb or maintenance as it could be very hot.

- Avoid any inflammable liquids, water or metal objects entering the unit. Once it happens, cut off the mains power immediately.
- Do not operate in dirty or dusty environment; do clean the fixture regularly.
- Do not touch any wire during operation as there might be a hazard of electric shock.
- Avoid power wires twist other cables.
- The minimum distance between light output and the illuminated surface must be more than 2.5 meters.
- Disconnect mains power before fuse/lamp replacement or servicing.
- Replace fuse/lamp only with the same type.
- In the event of serious operating problem, stop using the unit immediately.
- Never turn on and off the unit time after time.
- The housing, the lenses, or the ultraviolet filter must be replaced if they are visibly damaged.
- Do not open the unit as there are no user serviceable parts inside.
- Never try to repair the unit by yourself. Repairs carried out by unskilled people can lead to damage or malfunction. Please contact the nearest authorized technical assistance center if needed.
- Disconnect the mains power if the fixture is has not been used for a long time.
- Do use the original packing materials before transporting it once again.

Caution

Due to the magnifying type lens, please keep the lens out of contact with direct sunlight. Direct sunlight can cause heat to build up inside of the unit, which will seriously damage the unit.

- To prevent or reduce the risk of electrical shock or fire, do not expose the unit to rain or moisture.
- Hot lamp explosion hazard. Do not open the unit within 15 minutes after switching off.
- Do replace the bulb once it is damaged, deformed or life-expired.
- Do not look directly at the light while the bulb is on.
- Never touch bulb with bare fingers, as it is very hot after using.
- Do not start on the unit without bulb enclosure or when housing is damaged.

Product Items

- User manual
- 2 x Omega clamps

2. Installation

Unpacking the fixture (for flight case pack only)

1. Stop the flight case via the brake sheet above the wheels.
2. Unlock the lock modules (1) and open the cover board.
3. Prop the cover board with lid bracket.
4. Take out the fixture.
5. Unlock the lock module (2) take out omega clamps.

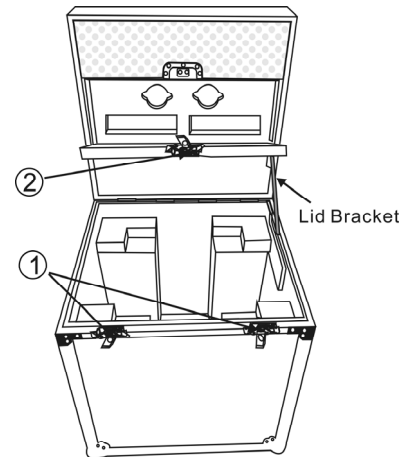

Installation:

1. Bolt each clamp (1) to the Omega holder with screw and lock nut through the hole in the holder.
2. Fasten the omega holders (2) on the bottom of the base by inserting quick-lock fasteners (3) into the holes of the base and tighten fully clockwise.
3. Hang the fixture to the support (4) through clamp and fasten the screws (5). Fasten the safety cable (6) through the bottom of the base and over the support.

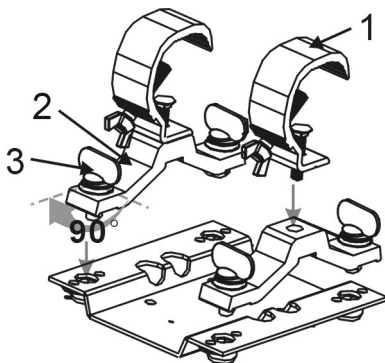

Fig.1

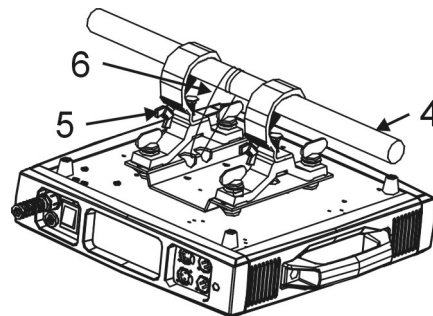

Fig.2

Attention:

- Always ensure that the structure to which you are attaching the unit is secure and is able to support a weight of 10 times of the unit's weight without any harming deformation.
- Also always use a safety cable that can hold 12 times of the weight of the unit when installing the fixture.
- Make absolute sure that the unit is firmly fixed in way that no vibrating or slipping would occur during operation.
- The equipment must be installed beyond the areas where persons may walk by or be seated.
- The rigging has to be operated by or under the guide of a skilled person.

3. Technical Specification

Power supply

- AC 100~240V 50/60Hz

Power Consumption

- 416W (230V)
- 434W (120V)

Fuse

- T 10 A

Lamp

- Philips MSR Gold 300/2 miniFastFit

Battery backup display

- Setting DMX address or other functions without connecting to mains power.
- Battery for LCD display charges automatically when the fixtures connects to the mains power.
- No need to change battery.

Wireless control (for the unit with wireless receiver built-in only)

- Wirelessly controlled by W-DMX (option).
- Each W-DMX is sending out 512 channels of DMX.
- License free band of 2.45 GHz

Optical system

- High efficiency optical system, delivering extremely powerful output
- High quality dichroic lenses
- Beam angle: 8°

Movement

- Pan: 540°
- Tilt: 270°
- Pan/Tilt moving speed adjustable.
- Automatic Pan/Tilt correction.
- Easy calibration and maintenance by magnetic home positioning.
- Pan/Tilt position lock for transporting protection.

Dimmer/Shutter

- Blackout, 0~100% smooth dimming, independent shutter and various strobe effect.

Color wheel

- Color wheel: 7 dichroic colors + open.
- Rainbow effect in both directions.
- Easy calibration and maintenance by magnetic home positioning.

CMY

- CMY speed adjustable.
- Optional multiple preset colors and macros available.

Gobo wheel

- Gobo size: Ø26.8mm (Ø24mm for image)
- Gobo Wheel: 7 rotating, indexable, easily replaceable gobos + open.
- Easy calibration and maintenance by magnetic home positioning.
- Module design for easy assembly and service.

Prism

- 3 facets prism with rotating effect.

Frost

- Frost effect.

Cool

- Fan cooled

Protocols

- DMX 512

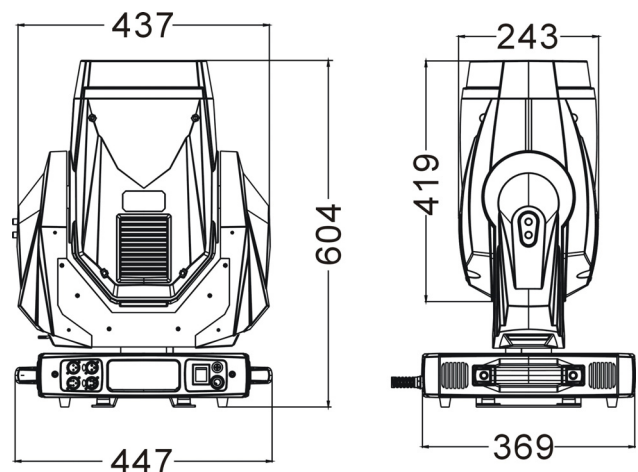

- Date input/output: 3/5 Pin XLR socket

Dimension

- 447 × 369 × 604 mm

Weight

- 21kgs

Photometric diagram

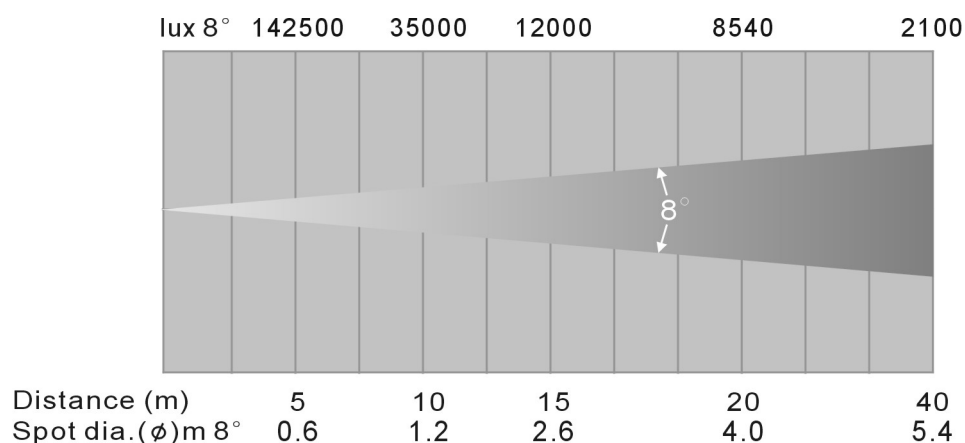

DMX Channels

Mode CH	Mode 1 18-CH	Mode 2 18-CH	Mode 3 25-CH
1	Pan	Shutter	Pan
2	Pan Fine	Dimmer	Pan Fine
3	Tilt	Cyan	Tilt
4	Tilt Fine	Magenta	Tilt Fine
5	Pan /Tilt Speed	Yellow	Pan /Tilt Speed
6	Shutter	Color	Dimmer
7	Dimmer	Gobo	Dimmer Fine
8	Color	R-Gobo	Shutter
9	Cyan	R-Gobo Fine	Color
10	Magenta	Prism	Cyan
11	Yellow	R-Prism	Magenta
12	Preset Color	Pan	Yellow
13	Gobo	Pan Fine	CMY Speed
14	R-Gobo	Tilt	Gobo
15	Prism	Tilt Fine	R-Gobo
16	R-Prism	Pan /Tilt Speed	R-Gobo Fine
17	Frost	Frost	Prism
18	Function	Function	R-Prism
19			R-Prism Fine

20			Frost
21			P/T Macro
22			P/T Macro Speed
23			Preset Color
24			Color Macro
25			Function

4. Description

4.1 Description of the fixture

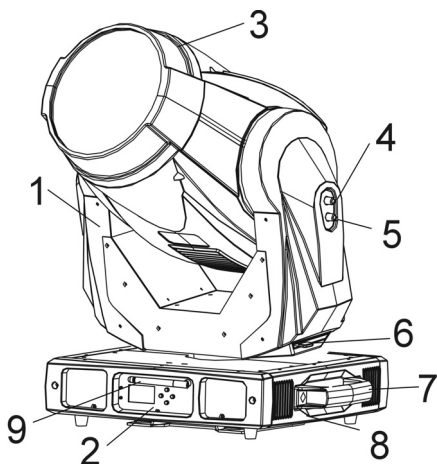

- 1. Arm
- 2. Front panel
- 3. head
- 4. Tilt lock button (Black)
- 5. Tilt unlock button (Gray)
- 6. Pan lock
- 7. Handle
- 8. Base
- 9. Antenna (for XP-300A BEAM WT only)

The head can be locked for transportation protection-the tilt lock button (4) is pressed and the pan lock/unlock lever (6) is in lock position. To unlock the head, press the tilt unlock button (5) and move the pan lock/unlock lever (6) to unlock position.

Caution: The head and arm must be unlocked before operation!

4.2 Control Panel

Front view

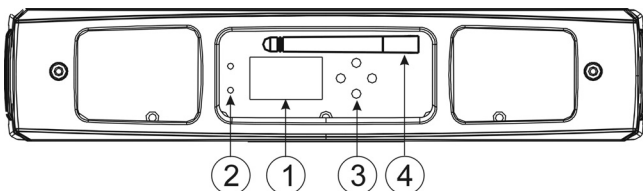

Rear view

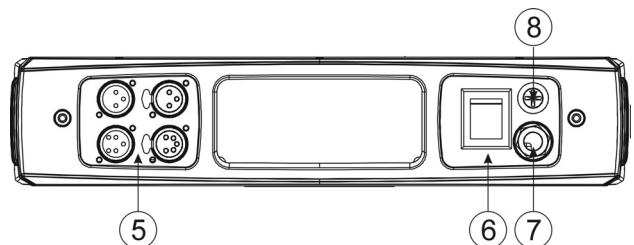

① **Monitor (Batter Back-up display):**

② LED

POWER	On	Power on
DMX	On	DMX input present

③ Button

MENU	To enter into, move backward or leave the menu
▲ UP	To go backward to move up in the menu
▼ DOWN	To go to move down in the menu
ENTER	To perform the desired functions

④ Antenna (for XP-300A BEAM WT only)

Receive wireless signal from a wide range

⑤ DMX input/output:

For DMX 512 operation, use 3/5-pin XLR plug cable to link the units together

⑥ Power Switch:

Turns On/Off the power

⑦ Power Cable:

To connect to the mains supply

⑧ Fuse (T 10 A):

Protect the unit from damage of overcurrent.

5. Gobo and Lamp

5.1 Inserting/Exchanging rotating gobos

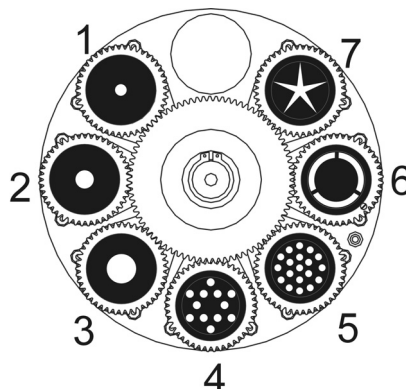

DANGER!
Install the gobos with the device switched off only.
Unplug from mains before changing gobos!

CAUTION: Never unscrew the screws of the rotating gobo as the ball bearing will otherwise be opened!

Please follow the steps below to insert/change rotating gobos

1. Open the cover by loosening the fastening screws on the cover.
2. Push the gobo plate (follow the direction 1) and gently pull out the plate (follow the direction 2).
3. Take out the ring with an appropriate tool. Do not touch the surface of the glass gobo.
4. Remove the original gobo and inset a new one (glazy side towards the lamp). Insert the ring to secure it in the gobo holder.
5. Install the gobo plate back into the gobo wheel. Make sure the gobo plate is installed under the pressure plate.

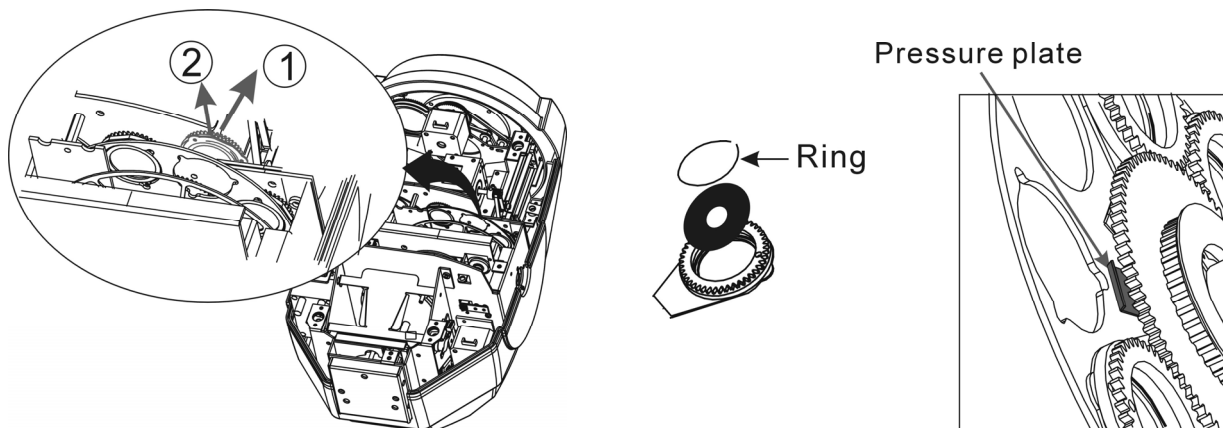

5.2 Lamp

MSR/ MSD Gold 300/2 miniFastFit

- Because of its high internal pressure, there might be a risk that the Discharge lamp would explode during operation. The lamp emits intense UV radiation which is harmful to the eyes and skin. The high luminance of the arc can cause severe damage to the retina if you take a close look at the lamp.
- To protect the lamp, always turn off the lamp first (via control panel or DMX

controller) and let the unit run at least five minutes to cool down before switching off the mains supply. Never handle the lamp or luminaire when it is hot.

- Do not touch the bulb with bare hands. If this happens, clean the lamp with denatured alcohol and wipe it with a lint free cloth before installation.
- The lamp generates UV radiation. Never operate the lamp without appropriate shielding.
- When lighting up, the lamp operates at high pressure and there is a slight risk of arc tube rupture. The risk increases with age, temperature and improper handling of the lamp. Do not use the lamp longer than its lifespan.
- Make sure the lamp is located in the center of the reflector for the best projection.

Change Lamp



In case of replacement of the lamp or maintenance, do not open the fixture within 15 minutes until the unit cools down after switching off.

1. Turn off the power.
2. Unscrew the two screws (A), open the lamp cover, turn it to the position as the sketch shown below.
3. Hold the base of the lamp, anticlockwise turn until it is parallel to the groove.
4. Inset a new lamp follow the groove, turn it clockwise to fix the lamp.
5. Tighten the screws (A) to fix the lamp cover.
6. Turn the screws (B) to adjust the lamp position be sure it is located in the center of the reflector for the best projection.

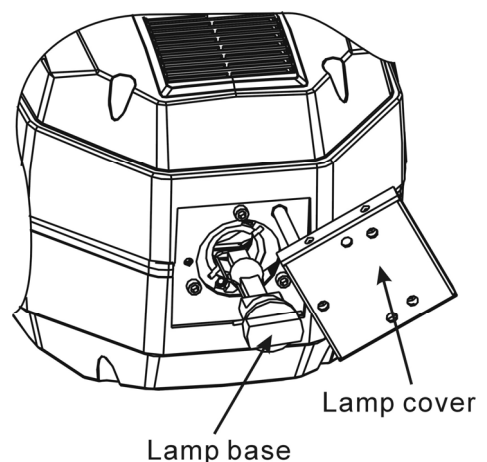
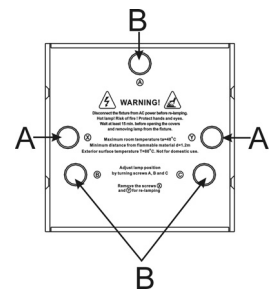

6. How To Set The Unit

6.1 Power On Display

Every time you turn on the unit, it will run built-in program to reset all motors to their home position, the display will show as fig.4, you may hear some noises for about 20 seconds. It will show warning sign if it goes wrong during resetting and you can press the MENU button to view the error information. After that the unit will be ready to receive DMX signal and the display will show as fig.5.



Fig.4



Fig.5

Explanation of fig.5:

- Base 40° C** Present temperature of base CPU is 40° C
- 001** Present start address
- Md.3 25Ch.** Present channel mode is mode 3 (25 channels mode)
- Temp 30° C** Present temperature of lamp is 30° C
-  Warning signal blinking direct resetting error

6.2 Main Function

Turn on the unit, press **MENU** button into menu mode, press **UP** and **DOWN** button until the required function is shown on the monitor. Select the function by **ENTER** button. Use **UP** and **DOWN** button to choose the submenu, press the **ENTER** button to store and automatically return to the last menu. Press **MENU** button or let the unit idle one minute to exit menu mode.

In the event of disconnecting with mains power, press **UP** button for one minute to enter into menu mode. Press **MENU** button or let the unit idle one minute to exit.

The main functions are shown below (the grayed boxes are preset settings) :

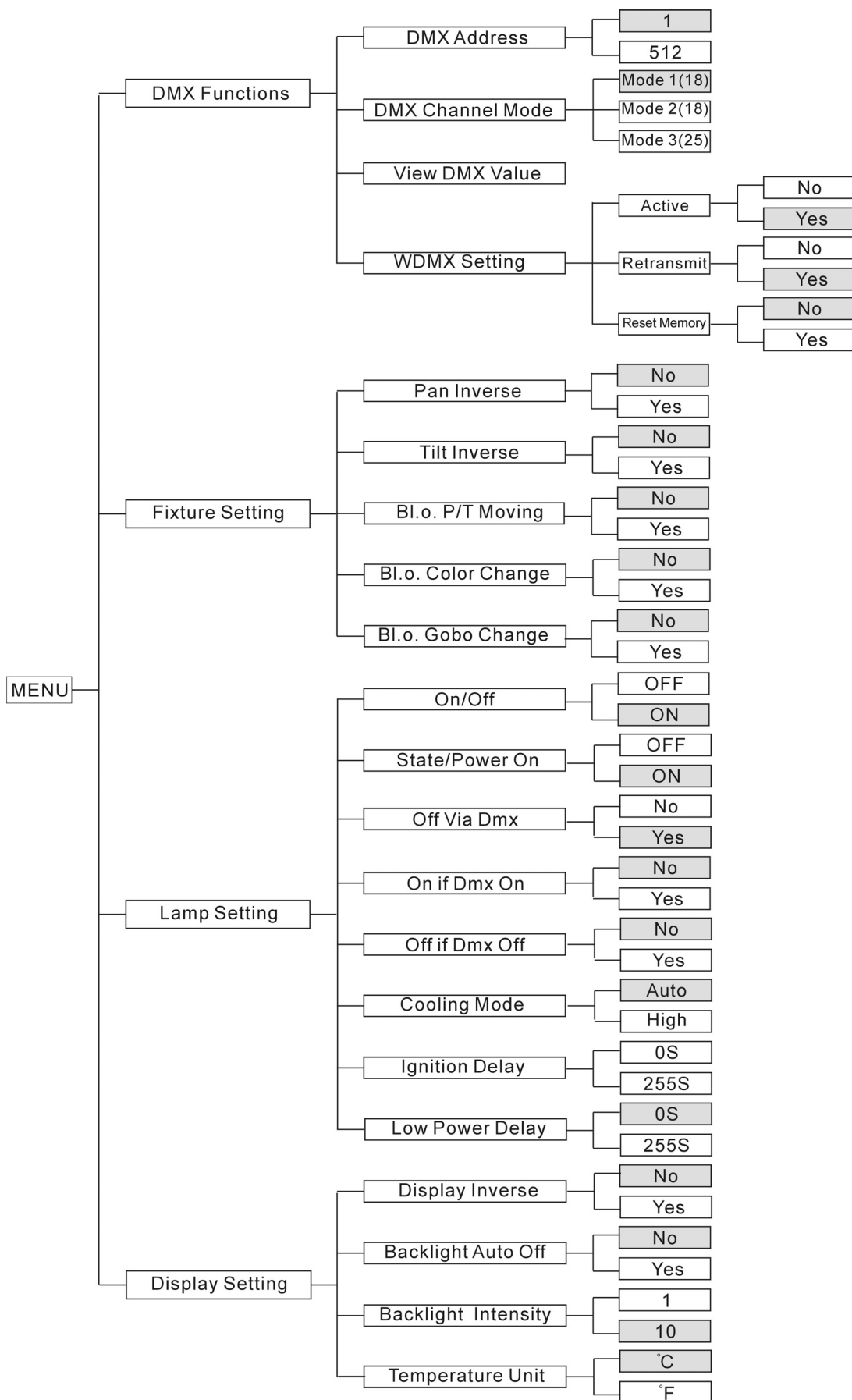

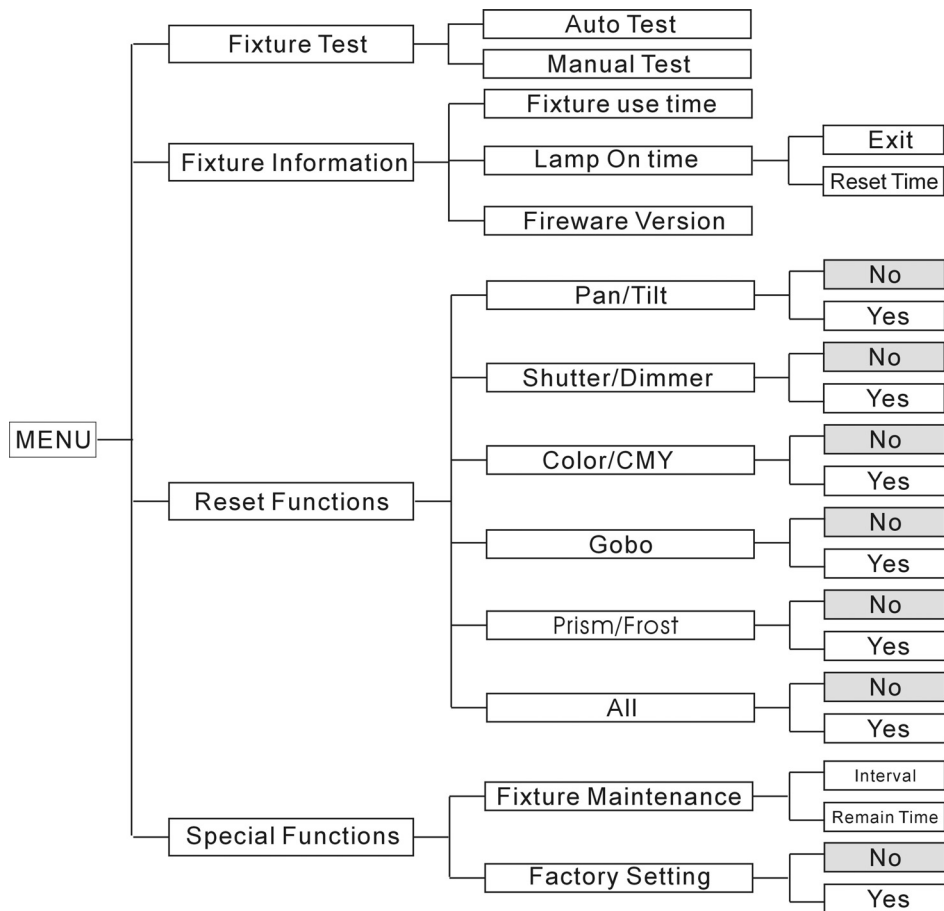

DMX Functions

Enter menu mode, select **DMX Functions**, press ENTER button to confirm, use UP and DOWN button to select **DMX Address**, **DMX Channel Mode**, **View DMX Value** or **WDMX Setting**.

DMX Address —DMX512 address setting

Select **DMX Address**, press ENTER button to confirm, the present address will blink on the display, use UP and DOWN button to adjust the address from **0** to **512**, press ENTER button to store. Press MENU button back to the last menu or let the unit idle one minute to exit menu mode.

DMX Channel Mode —channel mode

Select **DMX Channel Mode**, press ENTER button to confirm, present channel mode will blink on the display, use UP and DOWN button to select **Mode1 (18 channels mode)** or **Mode 2 (18 channels mode)** or **Mode 3 (25 channels mode)**, press ENTER

button to store. Press MENU button back to the last menu or let the unit idle one minute to exit menu mode.

View DMX Value

Select **View DMX Value**, press ENTER button to confirm. Channel function and its value will show on the display, use UP and DOWN button to view other DMX value. Press MENU button back to the last menu or let the unit idle one minute to exit menu mode.

WDMX Setting —*wireless control setting*

(For the unit with wireless receiver built-in only)

Select **WDMX Setting**, press ENTER button to confirm. use UP and DOWN button to select **Active**, **Retransmit** or **Reset Memory**, press ENTER button to store. Press MENU button back to the last menu or let the unit idle one minute to exit menu mode.

Active

Select **Active**, press ENTER button to confirm, use UP and DOWN button to select **Yes** (wireless control available) or **No** (wireless control unavailable), press ENTER button to store. Press MENU button back to the last menu or let the unit idle one minute to exit menu mode.

Retransmit

Select **Retransmit**, press ENTER button to confirm, use UP and DOWN button to select **Yes** or **No**, press ENTER button to store. Press MENU button back to the last menu or let the unit idle one minute to exit menu mode.

Reset Memory

Select **Reset Memory**, press ENTER button to confirm, use UP and DOWN button to select **Yes** (refuse wireless signal) or **No**, press ENTER button to store. Press MENU button back to the last menu or let the unit idle one minute to exit menu mode.

Fixture Setting

Enter menu mode, select **Fixture Setting**, press ENTER button to confirm, use UP and DOWN button to select **Pan Inverse**, **Tile Inverse**, **BL.O. P/T Moving**, **BL.O. Color Change** or **BL.O. Gobo Change**.

Pan Inverse

Select **Pan Inverse**, press ENTER button to confirm, present mode will blink on the display, use UP and DOWN button to select **No** (normal) or **Yes** (pan inverse), press ENTER button to store. Press MENU button back to the last menu or let the unit idle one minute to exit menu mode.

Tilt Inverse

Select **Tilt Inverse**, press ENTER button to confirm, present mode will blink on the display, use UP and DOWN button to select **No** (normal) or **Yes** (tilt inverse), press ENTER button to store. Press MENU button back to the last menu or let the unit idle one minute to exit menu mode.

BL.O. P/T Moving —*Blackout while pan/tilt moving*

Select **BL.O. P/T Moving**, Press ENTER button to confirm, present mode will blink on the display, use UP and DOWN button to select **No** (normal while pan/tilt moving) or **Yes** (blackout while pan/tilt moving), press ENTER button to store. Press MENU button back to the last menu or let the unit idle one minute to exit menu mode.

BL.O. Color Change —*Blackout while change color*

Select **BL.O. Color Change**, press ENTER button to confirm, present mode will blink on the display, use UP and DOWN button to select **No** (normal while change color) or **Yes** (blackout while change color), press ENTER button to store. Press MENU button back to the last menu or let the unit idle one minute to exit menu mode.

BL.O. Gobo Change —*Blackout while change gobo*

Select **BL.O. Gobo Change**, press ENTER button to confirm, present mode will blink on the display, use UP and DOWN button to select **No** (normal while changing gobo) or

Yes (blackout while changing gobo), press ENTER button to store. Press MENU button back to the last menu or let the unit idle one minute to exit menu mode.

Lamp Setting

Attention: The lamp will not be on unit detected temperature is lower than 45 ° C.

Enter menu mode, select **Fixture Setting**, press ENTER button to confirm, use UP and DOWN button to select **On/Off, State/Power on, Off Via Dmx, On if Dmx on, Off if Dmx off, Cooling Mode, Ignition Delay** or **Low Power Delay**.

On/Off—Turn on/off the lamp

Select **On/Off**, press ENTER button to confirm, present mode will blink on the display, use UP and DOWN button to select **On** (lamp on) or **Off** (lamp off), press ENTER button to store. Press MENU button back to the last menu or let the unit idle one minute to exit menu mode.

State/Power On—Lamp state while power on

Select **State/Power On**, press ENTER button to confirm, present mode will blink on the display, use UP and DOWN button to select **On** (Lamp on while power on) or **Off** (Lamp off while power on), press ENTER button to store. Press MENU button back to the last menu or let the unit idle one minute to exit menu mode.

Off Via DMX—Turn off the unit via DMX controller

Select **Off Via Dmx**, press ENTER button to confirm, present mode will blink on the display, use UP and DOWN button to select **Yes** (turn off the unit via DMX controller available) or **No** (turn off the unit via Dmx controller impracticable), press ENTER button to store. Press MENU button back to the last menu or let the unit idle one minute to exit menu mode.

(When you operate the unit via DMX controller, set the value of channel “special function” to “lamp off”, waiting for 5 seconds, then the lamp will be off if you choose “yes” mode).

On If DMX On— Lamp turns on when DMX signal is detected

Select **On If Dmx On**, press ENTER button to confirm, present mode will blink on the

display, use UP and DOWN button to select **Yes** (Lamp turns on when DMX signal is detected) or **No** (keep the present state), press ENTER button to store. Press MENU button back to the last menu or let the unit idle one minute to exit menu mode (*If the lamp is off via DMX signal, you can reconnect the DMX controller to make the lamp on*).

Off If DMX Off — Lamp turns off when DMX signal is cut off

Select **Off If Dmx Off**, press ENTER button to confirm, present mode will blink on the display, use UP and DOWN button to select **Yes** (Lamp turns off when DMX signal is cut off), press ENTER button to store. Press MENU button back to the last menu or let the unit idle one minute to exit menu mode.

Cooling Mode — Lamp turns off when DMX signal is cut off

Select **Cooling Mode**, press ENTER button to confirm, present mode will blink on the display, use UP and DOWN button to select **Auto** (fans speed adjust automatically) or **High** (fans run in high speed), press ENTER button to store. Press MENU button back to the last menu or let the unit idle one minute to exit menu mode.

Ignition Delay —*Delay time between power on and lamp on*

Select **Ignition Delay**, press ENTER button to confirm, present mode will blink on the display, use UP and DOWN button to adjust the delay time from 0S to 255S, press ENTER button to store. Press MENU button back to the last menu or let the unit idle one minute to exit menu mode.

Low Power Delay —*Delay time between reduce lamp power and shutter off the unit*

Select **Low Power Delay**, press ENTER button to confirm, present mode will blink on the display, use UP and DOWN button to adjust the delay time from 0S to 255S, press ENTER button to store. Press MENU button back to the last menu or let the unit idle one minute to exit menu mode.

(If you set the low power delay time to 3S, the lamp will run in half power 3 seconds after the unit shutter off)

Display Setting

Enter menu mode, select **Display Setting**, press ENTER button to confirm, use UP

and DOWN button to select **Display Inverse**, **Backlight Auto Off**, **Backlight Intensity** or **Temperature unit**.

Display Inverse

Select **Display Inverse**, press ENTER button to confirm, present mode will blink on the display, use UP and DOWN button to select **No** (normal display) or **Yes** (inverse display), press ENTER button to store. Press MENU button back to the last menu or let the unit idle one minute to exit menu mode.

Backlight Auto Off

Select **Backlight Auto Off**, press ENTER button to confirm, present mode will blink on the display, use UP and DOWN button to select **No** (display always on) or **Yes** (display goes off one minute after exiting menu mode), press ENTER button to store. Press MENU button back to the last menu or let the unit idle one minute to exit menu mode.

Backlight Intensity

Select **Backlight Intensity**, press ENTER button to confirm, present mode will blink on the display, use UP and DOWN button to adjust backlight intensity from **1** (dark) to **10** (bright), press ENTER button to store. Press MENU button back to the last menu or let the unit idle one minute to exit menu mode.

Temperature Unit

Select **Temperature Unit**, press ENTER button to confirm, present mode will blink on the display, use UP and DOWN button to select **°C** or **°F**, press ENTER button to store. Press MENU button back to the last menu or let the unit idle one minute to exit menu mode.

Fixture Test

Enter menu mode, select **Fixture Test**, press ENTER button to confirm, use UP and DOWN button to select **Auto Test** or **Manual Test**

Auto Test

Select **Auto Test**, press ENTER button to confirm, the unit will run built-in programs to automatically test pan, tilt, color, CMY, gobo, gobo rotation, shutter, dimmer, prism, prism rotation, frost, zoom, and lamp on/off. Press MENU button back to the last menu or exit menu mode after auto test.

Manual Test

Select **Manual Test**, press ENTER button to confirm, the present channel will show on the display, use Up and DOWN button to select channel, press ENTER button to confirm, then use UP and DOWN button to adjust the value, press ENTER button to store, the fixture will run as the channel value indicates. Press MENU button back to the last menu or exit menu mode let the unit idle one minute.

(All channels value will become 0 after exiting Manual Test menu)

Fixture Information

Enter menu mode, select **Fixture Information**, press ENTER button to confirm, use UP and DOWN button to select **Fixture Use Time**, **Lamp On Time** or **Firmware Version**.

Fixture Use Time

Select **Fixture Use Time**, press ENTER button to confirm, fixture use time will show on the display, press MENU button to exit.

Lamp On Time

Select **Lamp On Time**, press ENTER button to confirm, lamp on time will show on the display, press ENTER button to confirm, use UP and DOWN button to select **Exit** or **Reset Time**, press ENTER button to confirm. Press MENU button back to the last menu or exit menu mode let the unit idle one minute.

Firmware Version

Select **Firmware Version**, press ENTER button to confirm, firmware version will show on the display, press MENU button back to exit.

Reset Functions

Enter menu mode, select **Reset Function**, press ENTER button to confirm, use UP and DOWN button to select **Pan/Tilt**, **Shutter/Dimmer**, **Color/CMY**, **Gobo**, **Prism/Frost** or **All**.

Pan/Tilt—Reset Pan/Tilt

Select **Pan/Tilt**, press ENTER button to confirm, use UP and DOWN button to select **Yes** (the unit will run built-in program to reset pan and tilt to their home positions) or **No**, press ENTER button to store. Press MENU button back to the last menu or let the unit idle one minute to exit menu mode.

Shutter/Dimmer—Reset Shutter/Dimmer

Select **Shutter/Dimmer**, press ENTER button to confirm, use UP and DOWN button to select **Yes** (the unit will run built-in program to reset shutter and dimmer to their home positions) or **No**, press ENTER button to store. Press MENU button to exit.

Color/CMY—Reset Color/CMY

Select **Color/CMY**, press ENTER button to confirm, use UP and DOWN button to select **Yes** (the unit will run built-in program to reset color and CMY to their home positions) or **No**, press ENTER button to store. Press MENU button to exit.

GOBO—Reset GOBO

Select **GOBO**, press ENTER button to confirm, use UP and DOWN button to select **Yes** (the unit will run built-in program to reset GOBO wheel to their home positions) or **No**, press ENTER button to store. Press MENU button to exit.

Prism/Frost—Reset Prism/Frost

Select **Prism/Frost**, press ENTER button to confirm, use UP and DOWN button to select **Yes** (the unit will run built-in program to reset prism and frost to their home positions) or **No**, press ENTER button to store. Press MENU button to exit.

All—Reset All

Select **All**, press ENTER button to confirm, use UP and DOWN button to select **Yes** (the unit will run built-in program to reset all motors to their home positions) or **No**, press ENTER button to store. Press MENU button to exit.

Special Functions

Enter menu mode, select **Special Functions**, press ENTER button to confirm, use UP and DOWN button to select **Fixture Maintenance** or **Factory Setting**.

Fixture Maintenance

Select **Fixture Maintenance**, press ENTER button to confirm, use UP and DOWN button to select **Interval** or **Remain Time**.

Interval

Select **Interval**, press ENTER button to confirm, the interval time will show on the display. Press MENU button to exit.

Remain Time

Select **Remain Time**, press ENTER button to confirm, the remaining time will show on the display, press ENTER button to confirm, use UP and DOWN button to select **Exit** or **Resettime**, press MENU button to exit.

Factory Setting

Select **Factory Setting**, press ENTER button to confirm, the fixture will reset to factory settings and exit menu mode.

6.3. Home Position Adjustment

Press **MENU** button into menu mode, then press ENTER button for about 3 seconds into offset mode to adjust the home position. Select the function by **ENTER** button. Use **UP** and **DOWN** button to choose the submenu, press the **ENTER** button to store and automatically return to the last menu. Press MENU button to exit.

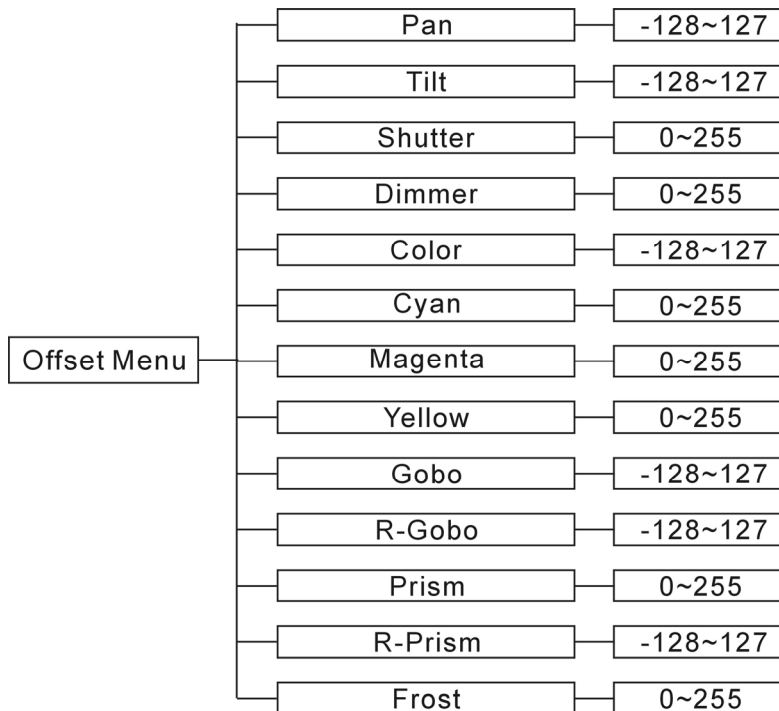

Pan—pan home position adjust

Enter offset mode, Select **Pan**, press ENTER button to confirm, the present position will blink on the display, use UP and DOWN button to offset the value from -128 to 127, press ENTER button to store. Press MENU button to exit.

Tilt—Tilt home position adjust

Enter offset mode, Select **Tilt**, press ENTER button to confirm, the present position will blink on the display, use UP and DOWN button to offset the value from -128 to 127, press ENTER button to store. Press MENU button to exit.

Shutter—Shutter home position adjust

Enter offset mode, Select **Shutter**, press ENTER button to confirm, the present position will blink on the display, use UP and DOWN button to offset the value from 0 to 255, press ENTER button to store. Press MENU button to exit.

Dimmer—Dimmer home position adjust

Enter offset mode, Select **Dimmer**, press ENTER button to confirm, the present position will blink on the display, use UP and DOWN button to offset the value from 0 to 255, press ENTER button to store. Press MENU button to exit.

Color—*Color home position adjust*

Enter offset mode, Select **Color**, press ENTER button to confirm, the present position will blink on the display, use UP and DOWN button to offset the value from -128 to 127, press ENTER button to store. Press MENU button to exit.

Cyan—*Cyan home position adjust*

Enter offset mode, Select **Cyan**, press ENTER button to confirm, the present position will blink on the display, use UP and DOWN button to offset the value from 0 to 255, press ENTER button to store. Press MENU button to exit.

Magenta—*Magenta home position adjust*

Enter offset mode, Select **Magenta**, press ENTER button to confirm, the present position will blink on the display, use UP and DOWN button to offset the value from 0 to 255, press ENTER button to store. Press MENU button to exit.

Yellow—*Yellow home position adjust*

Enter offset mode, Select **Yellow**, press ENTER button to confirm, the present position will blink on the display, use UP and DOWN button to offset the value from 0 to 255, press ENTER button to store. Press MENU button to exit.

Gobo—*Gobo home position adjust*

Enter offset mode, Select **Gobo**, press ENTER button to confirm, the present position will blink on the display, use UP and DOWN button to offset the value from -128 to 127, press ENTER button to store. Press MENU button to exit.

R-Gobo—*Gobo rotation home position adjust*

Enter offset mode, Select **R-Gobo**, press ENTER button to confirm, the present position will blink on the display, use UP and DOWN button to offset the value from -128 to 127, press ENTER button to store. Press MENU button to exit.

Prism—*Prism home position adjust*

Enter offset mode, Select **Prism**, press ENTER button to confirm, the present position will blink on the display, use UP and DOWN button to offset the value from 0 to 255, press

ENTER button to store. Press MENU button to exit.

R-Prism —Prism rotation home position adjust

Enter offset mode, Select **R-Prism**, press ENTER button to confirm, the present position will blink on the display, use UP and DOWN button to offset the value from -128 to 127, press ENTER button to store. Press MENU button to exit.

Frost —Frost home position adjust

Enter offset mode, Select **Frost**, press ENTER button to confirm, the present position will blink on the display, use UP and DOWN button to offset the value from 0 to 255, press ENTER button to store. Press MENU button to exit.

6.4. Error Information

Lamp Startup Fail

It appears when there is no lamp or some wires are damaged.

Temperature Sense Error

It appears when temperature check board is damaged.

Lamp Too Hot Power Off

It appears when temperature is detected higher than 110°C. Check if the unit is properly ventilated, or fans or temperature check board may is damaged.

Lamp Too Hot Low Power

It appears when temperature is detected higher than 105°C. the unit will run on a low power level.

Maintenance Fixture

It appears when the maintenance remaining time becomes 0S, please enter menu mode and reset the time.

Lamp On Over 700 Hour

It appears when the lamp has been on over 700 hours, please turn off the lamp.

Memory Initial Fail

It appears when the memory IC is damaged.

CPU-B Error, CPU-C Error, CPU-D Error

They appear when board P.C or some wires are damaged.

Pan Reset Error, Pan Encode Error, Tilt Reset Error, Tilt Encode Error, Shutter Reset Fail, Dimmer Reset Fail, Color Reset Fail, Cyan Reset Fail, Magenta Reset Fail, Yellow Reset Fail, Gobo Reset Fail, R-Gobo Reset Fail, Effect Reset Fail, R-Effect Reset Fail, and Frost Reset Fail

They may appear when turning on or resetting the unit, for some parts such as board P.C are damaged. Please contact the qualified maintenance.

7. Control By Universal DMX Controller

7.1 Connection

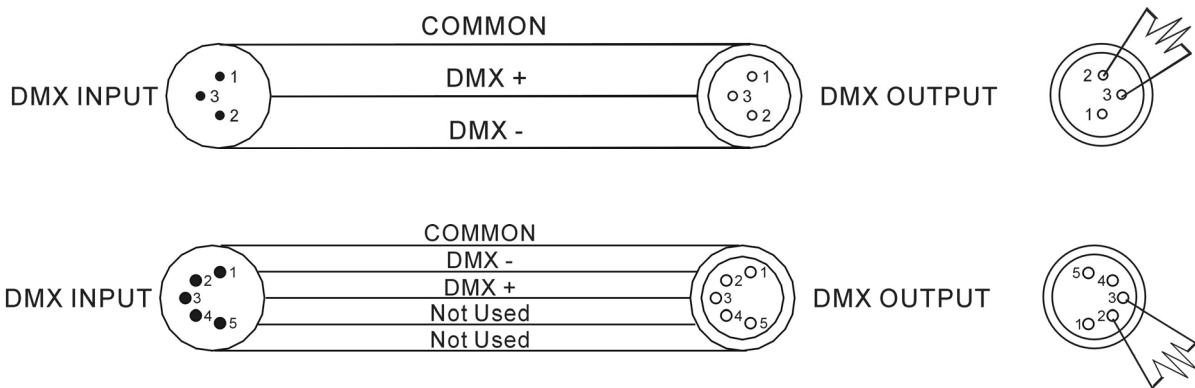
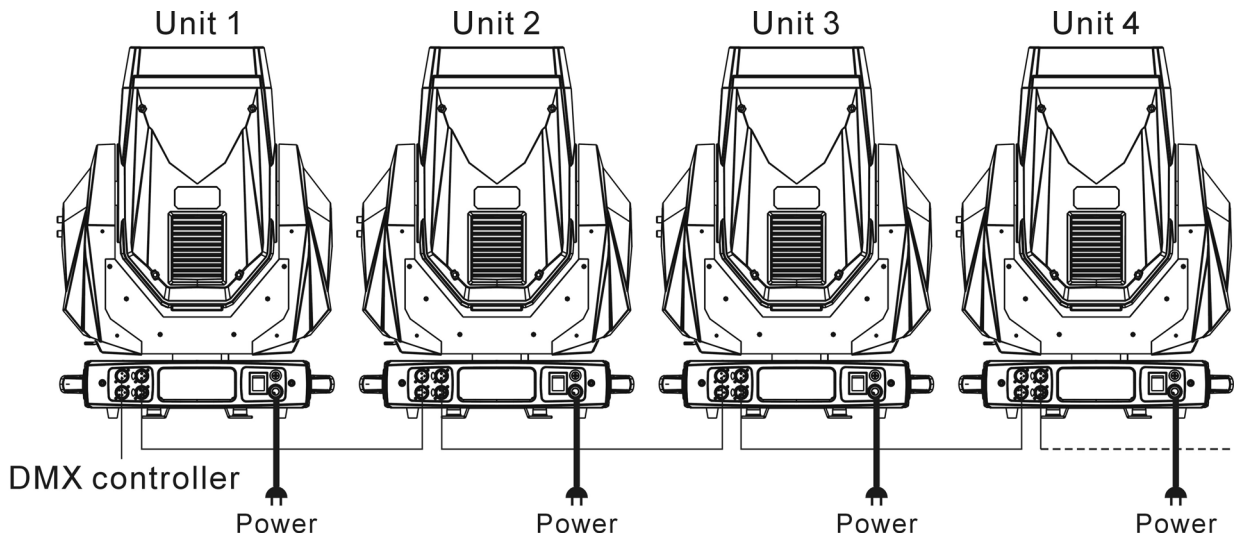

ATTENTION

Termination reduces signal errors and to avoid signal transmission problems and interference. It is always advisable to connect a DMX terminal (Resistance 120 ohm 1/4W between pin2 (DMX-) and pin3 (DMX+) of the last fixture).

1. At last unit, the DMX cable has to be terminated with a terminator. Solder a 120-ohm 1/4W resistor between pin 2(DMX-) and pin 3(DMX+) into a 3-pin XLR-plug and plug it in the DMX-output of the last unit.
2. Connect the unit together in a “daisy chain” by XLR plug cable from the output of the unit to the input of the next unit. The cable cannot be branched or split to a “Y” cable. DMX 512 is a very high-speed signal. Inadequate or damaged cables, soldered joints or corroded connectors can easily distort the signal and shut down the system.
3. The DMX output and input connectors are pass-through to maintain the DMX circuit, when one of the units’ power is disconnected.
4. Each lighting unit needs to have a DMX address to receive the data by the controller. The address number is between 0-511 (usually 0 & 1 are equal to 1).
5. The end of the DMX 512 system should be terminated to reduce signal errors.
6. 3 pin XLR connectors are more popular than 5 pins XLR.
 - 3 pin XLR: Pin 1: GND, Pin 2: Negative signal (-), Pin 3: Positive signal (+)
 - 5 pin XLR: Pin 1: GND, Pin 2: Negative signal (-), Pin 3: Positive signal (+), Pin4, Pin5 not used.

7.2 Channel Mode Setting

Enter menu mode, select **DMX Functions**, press ENTER button to confirm, use UP and DOWN button to select **DMX Channel Mode**, press ENTER button to confirm, present channel mode will blink on the display, use UP and DOWN button to select **Mode1 (18 channels mode)** or **Mode 2 (18 channels mode)** or **Mode 3 (25 channels mode)**, press ENTER button to store. Press MENU button back to the last menu or let the unit idle one minute to exit menu mode.

7.3 Address Setting

If you use a universal DMX controller to control the units, you have to set DMX address from 1 to 512 so that the units can receive DMX signal.

Press MENU button to enter menu mode, select **DMX Functions**, press ENTER button to confirm, use UP and DOWN button to select **DMX Address**, press ENTER button to confirm, the present address will blink on the display, use UP and DOWN button to adjust the address from 0 to 512, press ENTER button to store. Press MENU button back to the last menu or let the unit idle one minute to exit menu mode.

Please refer to the following diagram to address your DMX512 channel for the first 4 units.

Channel mode	Unit 1 Address	Unit 2 Address	Unit 3 Address	Unit 4 Address
18 channels	1	19	37	55
25 channels	1	26	51	76

7.4 DMX 512 Configuration





Please refer to below configurations to control the fixtures

Attention:







1. The unit will maintain the last condition until reset if you cut-off the DMX signal.
2. For the channel Function, keep the value for about 5 seconds, then the corresponding function will take into effect.





















18 Channels mode 1:

18 Channels(Mode 1)						
Ch1	Ch2	Ch3	Ch4	Ch5	Ch6	Ch7
Pan	Pan Fine	Tilt	Tilt Fine	Pan/Tilt Speed	Shutter	Dimmer
255 540° 0 0°	255 0	255 270° 0 0°	255 0	255 Slow 0 Fast	248-255 Open 240-247 Random Strobe 204-239 Slow Open Slow close 168-203 Slow Close Fast Open 132-167 Slow Open Fast Close ⚡⚡⚡ 16-131 ⚡⚡ ⚡ 8-15 Open 0-7 Blackout	255 100% 0 0%
Ch8	Ch9	Ch10	Ch11	Ch12	Ch13	
Color	Cyan	Magenta	Yellow	Reset Color	Gobo	
255 Rotation Fast 192 Rotation Slow 191 Rotation Slow 128 Rotation Fast 064-127 Color Mix 056-063 Blue 048-055 Green 040-047 Pink 032-039 5600K 024-031 3200K 016-023 Orange 008-015 Red 001-007 White	255 100% 0 0%	255 100% 0 0%	255 100% 0 0%	234-255 Color 11 213-233 Color 10 192-212 Color 9 171-191 Color 8 149-170 Color 7 128-148 Color 6 107-127 Color 5 086-106 Color 4 064-085 Color 3 043-063 Color 2 022-042 Color 1 001-021 White	255 Fast 192 Slow 191 Slow 128 Fast 118-127 Gobo 7 Shaking 108-117 Gobo 6 Shaking 098-107 Gobo 5 Shaking 088-097 Gobo 4 Shaking 078-087 Gobo 3 Shaking 068-077 Gobo 2 Shaking 058-067 Gobo 1 Shaking 050-057 ⚙️ 043-049 ⚙️ 036-042 ⚙️ 029-035 ⚙️ 022-028 ⚙️ 015-021 ⚙️ 008-014 ⚙️ 001-007 ○	











18Channels(Mode 1)				
Ch14	Ch15	Ch16	Ch17	Ch18
R-Gobo	Prism	R-Prism	Frost	Function
255 Rotation Fast  192 Rotation Slow 191 Rotation Slow  128 Rotation Fast 0-127 Index	128-255 28 Prism Rotation Effects 8-127 Prism Effect 0-7 No Function	255 Rotation Fast  192 Rotation Slow 191 Rotation Slow  128 Rotation Fast 0-127 Index	255 100%  0 0%	240-255 No Function 230-239 Lamp Off 210-229 No Function 200-209 Reset All 190-199 Frost/Prism Reset 180-189 No Function 170-179 Shutter reset 160-169 Gobo reset 150-159 Color/CMY Reset 140-149 Pan/Tilt reset 130-139 Lamp On 120-129 Disable Blackout while gobo change 110-119 Enable Blackout while gobo change 100-109 Disable Blackout while color change 090-099 Enable Blackout while color change 080-089 Disable Blackout while Pan/Tilt Move 070-079 Enable Blackout while Pan/Tilt Move 000-069 No Function

18 Channels mode 2:

18Channels(Mode 2)					
Ch1	Ch2	Ch3	Ch4	Ch5	Ch6
Shutter	Dimmer	Cyan	Magenta	Yellow	Color
248-255 Open 240-247 Random Strobe 204-239 Slow Open Slow close 168-203 Slow Close Fast Open 132-167 Slow Open Fast Close ⚡⚡⚡ 16-131 ⚡⚡ ⚡ 8-15 Open 0-7 Blackout	255 100%  0 0%	255 100%  0 0%	255 100%  0 0%	255 100%  0 0%	255 Rotation Fast  192 Rotation Slow 191 Rotation Slow  128 Rotation Fast 064-127 Color Mix 056-063 Blue 048-055 Green 040-047 Pink 032-039 5600K 024-031 3200K 016-023 Orange 008-015 Red 001-007 White

18Channels(Mode 2)					
Ch7	Ch8	Ch9	Ch10	Ch11	Ch12
Gobo	R-Gobo	R-Gobo Fine	Prism	R-Prism	Pan
255 Fast  192 Slow 191 Slow  128 Fast 118-127 Gobo 7 Shaking 108-117 Gobo 6 Shaking 098-107 Gobo 5 Shaking 088-097 Gobo 4 Shaking 078-087 Gobo 3 Shaking 068-077 Gobo 2 Shaking 058-067 Gobo 1 Shaking 050-057  043-049  036-042  029-035  022-028  015-021  008-014  001-007 	255 Rotation Fast  192 Rotation Slow 191 Rotation Slow  128 Rotation Fast 0-127 Index	255  0	128-255 28 Prism Rotation Effects 8-127 Prism Effect 0-7 No Function	255 Rotation Fast  192 Rotation Slow 191 Rotation Slow  128 Rotation Fast 0-127 Index	255 540°  0 0°
Ch13	Ch14	Ch15	Ch16	Ch17	Ch18
Pan Fine	Tilt	Tilt Fine	Pan/Tilt Speed	Frost	Function
255  0	255 270°  0 0°	255  0	255 Slow  0 Fast	255 100%  0 0%	240-255 No Function 230-239 Lamp Off 210-229 No Function 200-209 Reset All 190-199 Frost/Prism Reset 180-189 No Function 170-179 Shutter reset 160-169 Gobo reset 150-159 Color/CMY Reset 140-149 Pan/Tilt reset 130-139 Lamp On 120-129 Disable Blackout while gobo change 110-119 Enable Blackout while gobo change 100-109 Disable Blackout while color change 090-099 Enable Blackout while color change 080-089 Disable Blackout while Pan/Tilt Move 070-079 Enable Blackout while Pan/Tilt Move 000-069 No Function

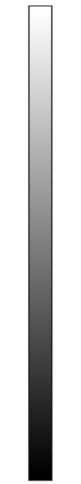
25 Channels mode:

25Channels(Mode 3)					
Ch1	Ch2	Ch3	Ch4	Ch5	Ch6
Pan	Pan Fine	Tilt	Tilt Fine	Pan/Tilt Speed	Function
255 540°  0 0°	255  0	255 270°  0 0°	255  0	255 Slow  0 Fast	240-255 No Function 230-239 Lamp Off 210-229 No Function 200-209 Reset All 190-199 Frost/Prism Reset 180-189 No Function 170-179 Shutter reset 160-169 Goboreset 150-159 Color/CMY Reset 140-149 Pan/Tilt reset 130-139 Lamp On 120-129 Disable Blackout while gobo change 110-119 Enable Blackout while gobo change 100-109 Disable Blackout while color change 090-099 Enable Blackout while color change 080-089 Disable Blackout while Pan/Tilt Move 070-079 Enable Blackout while Pan/Tilt Move 000-069 No Function
Ch7	Ch8	Ch9	Ch10	Ch11	Ch12
P/T Macro	P/T Macro Speed	Color	Cyan	Magenta	Yellow
248-255Macro27 232-247Macro26 224-231Macro25 208-223Macro24 192-207Macro23 184-191Macro22 176-183Macro21 168-175Macro20 160-167Macro19 152-159Macro18 144-151Macro17 136-143Macro16 128-135Macro15 121-127Macro14 104-120Macro13 096-103Macro12 088-095Macro11 080-087Macro10 072-079Macro9 064-071Macro8 056-063Macro7 048-055Macro6 040-047Macro 5 032-039Macro4 024-031Macro3 016-023Macro2 008-015 Macro1 000-007 Stop	255 Slow  0 Fast	255 Rotation Fast  192 Rotation Slow 191 Rotation Slow  128 Rotation Fast 064-127 Color Mix 056-063 Blue 048-055 Green 040-047 Pink 032-039 5600K 024-031 3200K 016-023 Orange 008-015 Red 001-007 White	255 100%  0 0%	255 100%  0 0%	255 100%  0 0%

25Channels(Mode 3)						
Ch13	Ch14	Ch15	Ch16	Ch17	Ch18	
Preset Color	CMY Speed	Color Macro	Gobo	R-Gobo	R-Gobo Fine	
234-255 Color11 213-233 Color10 192-212 Color9 171-191 Color8 149-170 Color7 128-148 Color6 107-127 Color5 086-106 Color4 064-085 Color3 043-063 Color2 022-042 Color1 000-021 White	255 Slow 0 Fast	236-255Macro12 216-235Macro11 195-215Macro10 174-194 Macro9 153-173 Macro8 132-152 Macro7 111-131 Macro6 091-110 Macro5 070-090 Macro4 050-069 Macro3 029-049 Macro2 008-028 Macro1 000-007 Open	255 Fast ↻ 192 Slow 191 Slow ↻ 128 Fast 118-127 Gobo 7 Shaking 108-117 Gobo 6 Shaking 098-107 Gobo 5 Shaking 088-097 Gobo 4 Shaking 078-087 Gobo 3 Shaking 068-077 Gobo 2 Shaking 058-067 Gobo 1 Shaking 050-057 ★ 043-049 ● 036-042 ● 029-035 ● 022-028 ● 015-021 ● 008-014 ● 001-007 ○	255 Rotation Fast ↻ 192 Rotation Slow 191 Rotation Slow ↻ 128 Rotation Fast 0-127 Index	255 0	
Ch19	Ch20	Ch21	Ch22	Ch23	Ch24	Ch25
Prism	R-Prism	R-Prism Fine	Frost	Shutter	Dimmer	Dimmer Fine
128-255 28 Prism Rotation Effects 8-127 Prism Effect 0-7 No Function	255 Rotation Fast ↻ 192 Rotation Slow 191 Rotation Slow ↻ 128 Rotation Fast 0-127 Index	255 0	255 100% 0 0%	248-255 Open 240-247 Random Strobe 204-239 Slow Open Slow close 168-203 Slow Close Fast Open 132-167 Slow Open Fast Close 16-131 ⚡⚡⚡ 8-15 ⚡ 0-7 Open Blackout	255 100% 0 0%	255 0

8. Update Software

Download update file from our web site, follow the user manual of IU-01 to update the fixture via IU-01(not included).

9. Troubleshooting

Following are a few common problems that may occur during operation. Here are some suggestions for easy troubleshooting:

A. The unit does not work, no light and the fan does not work

1. Check the connect power and main fuse.
2. Measure the mains voltage on the main connector.
3. Check the power on LED to see if it can be light up or not.

B. Not responding to DMX controller

1. DMX LED should be on. If not, check DMX connectors, cables to see if they are linked properly.
2. If the DMX LED is on and no response to the channel, check the address settings and DMX polarity.
3. If you have intermittent DMX signal problems, check the pins on connectors or on PCB of the unit or the previous one.
4. Try to use another DMX controller.
5. Check to see if the DMX cables run near or run alongside high voltage cables that may cause damage or interference to DMX interface circuit.

C. One of the channels is not working well

1. The stepper motor might be damaged or the cable connected to the PCB is broken.
2. The motor's drive IC on the PCB might be out of condition.

D. The lamp is cutting out intermittently

1. The lamp is not working well. Check the mains voltage either too high or too low.
2. Internal temperature may be too high. Check if replacement of fan is needed on the head.

E. If The pan belt is broken

1. Turn off the mains power.
2. Loosen the screws (A), open the cover ().
3. Loosen the screws (C).
4. Unplug all the connect wires over the belt.
5. Change a new belt (D), put the belt around the axis gear and motor gear.
6. Plug all the connect wires back upon the belt.
7. Tighten all the screws.

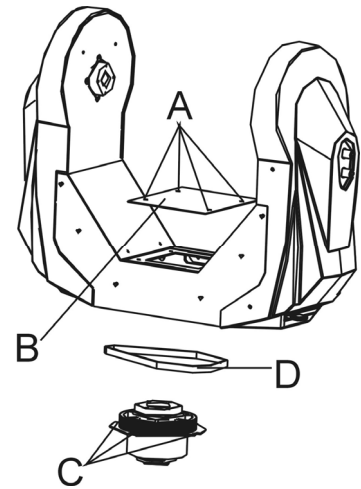

F. If The tilt belt is broken

1. Turn off the mains power.
2. Loosen all the screws (A) and open the right arm cover (B).
3. Loosen the screws (C) that fix the bridge.
4. Change a new belt (D). Please adjust the tension of the belt properly. Note: do not fix the belt too tight as it is can easily rupture.
5. Reverse the procedures from step 3 to 2.

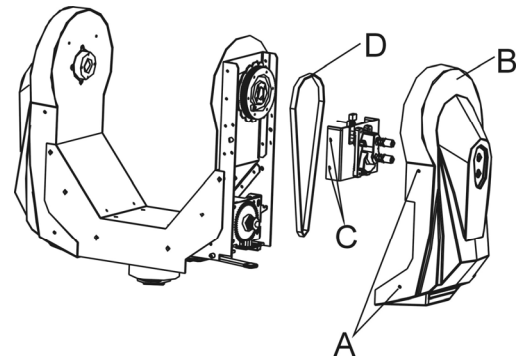

10. Maintenance and Cleaning

Maintenance:

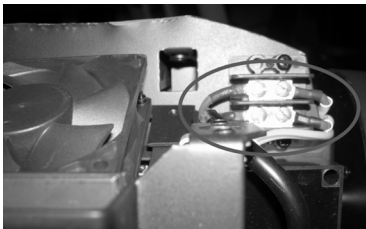

Ignitor



Ballast

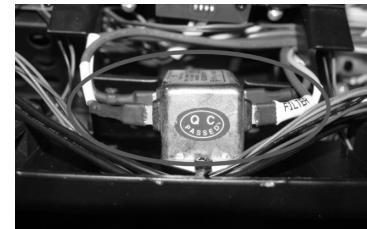

Filter

- A. As the pictures shown above, please replace the cable or cable joints immediately once they've turned yellow.
- B. Do maintain the fixtures every two months and make sure that all the screws and terminals have been locked firmly to make sure the normal performance of the fixtures.

Negligence of maintenance would cause malfunction of the fixture.

Cleaning:

The cleaning of internal and external optical lenses and/or mirrors must be carried out periodically to optimize light output. Cleaning frequency depends on the environment in which the fixture operates: damp, smoky or particularly dirty surrounding can cause greater accumulation of dirt on the unit's optics.

- Clean with soft cloth and use normal glass to clean fluid.
- Always dry the parts carefully.
- Clean the external optics at least every 20 days. Clean the internal optics at least every 30/60 days.

EC Declaration of Conformity

We declare that our products (lighting equipments) comply with the following specification and bears CE mark in accordance with the provision of the Electromagnetic Compatibility (EMC) Directive 89/336/EEC.

EN55103-1:1996; EN55103-2:1996;
EN61000-3-2:2006
EN61000-3-3:1995+A1:2001+A2:2005.

&

Harmonized Standard

EN 60598-2-17: 1989 +A2: 1991
IEC 60598-1: 2008
Part 1:General requirements and test

Following the provisions of the low voltage directive 73/23/EEC and 93/68/EEC

Innovation, Quality, Performance